



SLIDING PATIO DOOR

SECTION DIRECTORY



General Information

Product Summary.....	F-SPD-2
Product Selection Guide	
Size and Performance Data	F-SPD-3
Features and Options.....	F-SPD-4
Glazing Performance	F-SPD-5

Product Details

Sound Transmission Class and Outdoor-Indoor Transmission Class	F-SPD-7
Combination Assemblies	F-SPD-7
Grille Types	F-SPD-8
Size Tables.....	F-SPD-9
Design Data	F-SPD-10
Detailed Product Descriptions	F-SPD-12
Unit Sections.....	F-SPD-13

General Notes:

Specifications subject to change without notice. Go to www.PellaADM.com for most current technical data.

For complete CSI Format Specifications, see www.PellaADM.com.

X = Venting or sliding panel as viewed from the exterior.

O = Fixed panel as viewed from the exterior.



SLIDING PATIO DOOR

BRAND SUMMARY



Pella® Impervia® Sliding Patio Doors

are traditional in every detail-with all the Pella innovations you demand. The frame and panel material feature Duracast® fiberglass composite, Pella's patented, five layer, engineered fiberglass composite. Duracast fiberglass composite is the strongest, most durable material available in windows and doors. Each door uses three-way reinforced corners for increased strength. All frame and panel corners are locked in place with corner keys and injected with a dual purpose sealant/adhesive for long-lasting performance. Frame corners are additionally secured with mechanical fasteners. Pella Impervia doors are prefinished with a powder-coat paint. This paint meets the stringent AAMA 623 standards. Powder-coat paint is resistant to dents, scratches and damaging UV light. Duracast fiberglass composite can withstand extreme heat (over 200° F), intense cold (-40° F), and is seacoast worthy.



BLOCK FRAME

The versatile block frame design allows units to be installed in masonry openings using installation clips or in wood frame openings using optional fins. Transom and door units can also be field-joined together.

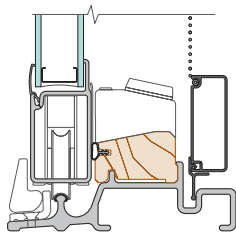



SLIDING PATIO DOOR

PRODUCT SELECTION GUIDE

Size and Performance Data



BLOCK FRAME

SIZES

Standard Sizes	●
6' 8" Door Heights	●
6' 10" Door Heights	●
8' Door Heights	●
Available in Fixed-Vent (OX), Vent-Fixed (XO) and Fixed (O)	●
Special Sizes	●

6-0/6-10

6-0/6-10 WITH
HIGH
PERFORMANCE
RETAINER

8-0/8-0

8-0/8-0 WITH
HIGH
PERFORMANCE
RETAINER

PERFORMANCE (VENT SINGLE UNITS ONLY)

Meets or Exceeds AAMA/WDMA Ratings	SD-LC45 Hallmark Certified	SD-LC50 Hallmark Certified	SD-LC30 Hallmark Certified	SD-LC35 Hallmark Certified
Air Infiltration (cfm/ft ² of frame @ 1.57 psf wind pressure) ₁	0.04	0.04	0.04	0.04
Design Pressure	45 psf	50 psf	30 psf	35 psf
Water Resistance	6.75 psf	7.5 psf	4.5 psf	5.25 psf

OTHER PERFORMANCE CRITERIA

Forced Entry Resistance Level (Minimum Security Grade) ₂	40/10	40/10	40/10	40/10
Maximum Operating Force (lb) Initiate Motion/Maintain Motion	25/12	25/12	25/12	25/12
Maximum Locking Force (lb) Lock/Unlock	4/5	4/5	4/5	4/5

S = Standard; O = Optional

(1) Published performance data for air infiltration is determined by testing a minimum of four (4) products of NFRC model size. Testing is conducted in accordance with ASTM E283. Air infiltration ratings for products will differ by size. The performance data does not apply to combination assemblies unless noted. Actual product performance may vary for a number of reasons including installation and product care.

(2) The higher the level, the greater the product's ability to resist forced entry. Grade 40 is achieved with a block frame screw install and grade 10 is achieved with a fin install.



SLIDING PATIO DOOR

PRODUCT SELECTION GUIDE

Features and Options



	BLOCK FRAME
GLAZING	
Glazing Type	
Dual-pane Insulating Glass	S
Insulated Glass Options / Low-E Types	
Clear Insulating Glass (no Low-E coating)	S
Advanced Low-E Insulating Glass	O
SunDefense™ Low-E Insulating Glass	O
AdvancedComfort Low-E Insulating Glass	O
NaturalSun Low-E Insulating Glass	O
Additional Glass Options	
Tempered Glass	S
Obscure Glass ¹	O
Gas Fill / High Altitude	
Argon	S
High Altitude	O
High Altitude with argon	O
EXTERIOR / INTERIOR	
Powder-Coat White	S
Powder-Coat Tan, Brown, Black, or Morning Sky Gray	O
Dual-color (All exterior colors available with White interior)	O

	BLOCK FRAME
INTERIOR HARDWARE FINISH	
Match interior finish	S
Satin Nickel, Bright Brass, Antique Brass, Oil-Rubbed Bronze, Chrome	O
EXTERIOR HARDWARE FINISH	
Match exterior finish	S
LOCKING SYSTEM	
Multi-Point Locking System - electroplated steel	S
Multi-Point Locking System - Stainless Steel	O
Keylock	O
Foot Bolt	S
GRILLES	
Grilles-Between-the-Glass	
3/4" contoured White, Tan, Brown, Black, or Morning Sky Gray (match interior and exterior finish)	O
Patterns	
Traditional	O
Prairie	O
Top Row	O
Special	O
SCREENS	
Conventional black fiberglass interior sliding screen door	O
InView™ fiberglass interior sliding screen door	O

S = Standard; O = Optional

(1) Contact your local Pella sales representative for current offering.



SLIDING PATIO DOOR

GLAZING PERFORMANCE - TOTAL UNIT



Glass Thickness	Type of Glazing	NFRC Certified Product #	Glass (mm)		Gap Fill	Performance Values ₁				Shaded Areas Meet ENERGY STAR® Performance Criteria in Zones Shown											
			Ext.	Int.		U-Factor	SHGC	VLT %	CR	U. S.					Canada ₂						
										Zone					ER	Zone					
											N	NC	SC	S							
1"	Clear IG	PEL-N-123-00235-00001	3	3	air	0.48	0.61	63	44												
	with grilles-between-the-glass	PEL-N-123-00236-00001				0.48	0.53	55	44												
1"	Clear IG	PEL-N-123-00237-00001	4	4	air	0.48	0.59	63	44												
	with grilles-between-the-glass	PEL-N-123-00238-00001				0.48	0.52	55	44												
1"	Clear IG	PEL-N-123-00239-00001	5	5	air	0.48	0.58	62	44												
	with grilles-between-the-glass	PEL-N-123-00240-00001				0.48	0.51	55	44												
1"	Advanced Low-E IG	PEL-N-123-00291-00001	3	3	argon	0.32	0.29	54	54												
	with grilles-between-the-glass	PEL-N-123-00292-00001				0.32	0.26	47	54												
1"	Advanced Low-E IG	PEL-N-123-00293-00001	4	4	argon	0.32	0.28	53	54												
	with grilles-between-the-glass	PEL-N-123-00294-00001				0.32	0.25	47	54												
1"	Advanced Low-E IG	PEL-N-123-00295-00001	5	5	argon	0.32	0.28	53	54												
	with grilles-between-the-glass	PEL-N-123-00296-00001				0.32	0.25	46	54												
1"	SunDefense™ IG	PEL-N-123-00307-00001	3	3	argon	0.32	0.22	50	54												
	with grilles-between-the-glass	PEL-N-123-00308-00001				0.32	0.19	44	54												
1"	SunDefense™ IG	PEL-N-123-00309-00001	4	4	argon	0.31	0.22	50	54												
	with grilles-between-the-glass	PEL-N-123-00310-00001				0.31	0.19	43	54												
1"	SunDefense™ IG	PEL-N-123-00311-00001	5	5	argon	0.31	0.21	49	54												
	with grilles-between-the-glass	PEL-N-123-00312-00001				0.31	0.19	43	54												
1"	AdvancedComfort Low-E IG	PEL-N-123-00339-00001	3	3	argon	0.27	0.28	53	47								22				
	with grilles-between-the-glass	PEL-N-123-00340-00001				0.27	0.25	46	47							20					
1"	AdvancedComfort Low-E IG	PEL-N-123-00341-00001	4	4	argon	0.27	0.28	52	46							22					
	with grilles-between-the-glass	PEL-N-123-00342-00001				0.27	0.25	46	46						20						
1"	AdvancedComfort Low-E IG	PEL-N-123-00343-00001	5	5	argon	0.27	0.28	52	46						22						
	with grilles-between-the-glass	PEL-N-123-00344-00001				0.27	0.25	45	46					20							
1"	NaturalSun Low-E IG	PEL-N-123-00275-00001	3	3	argon	0.33	0.54	61	53						29						
	with grilles-between-the-glass	PEL-N-123-00276-00001				0.33	0.47	53	53					25							
1"	NaturalSun Low-E IG	PEL-N-123-00277-00001	4	4	argon	0.33	0.52	61	54					28							
	with grilles-between-the-glass	PEL-N-123-00278-00001				0.33	0.46	53	54					25							
1"	NaturalSun Low-E IG	PEL-N-123-00279-00001	5	5	argon	0.32	0.51	60	54					29							
	with grilles-between-the-glass	PEL-N-123-00280-00001				0.32	0.45	52	54					25							
WITH FOAM INSULATION																					
1"	Advanced Low-E IG	PEL-N-123-00419-00001	3	3	argon	0.30	0.29	54	58												
	with grilles-between-the-glass	PEL-N-123-00420-00001				0.30	0.26	47	58												
1"	Advanced Low-E IG	PEL-N-123-00421-00001	4	4	argon	0.29	0.28	53	58												
	with grilles-between-the-glass	PEL-N-123-00422-00001				0.29	0.25	47	58												
1"	Advanced Low-E IG	PEL-N-123-00423-00001	5	5	argon	0.29	0.28	53	58												
	with grilles-between-the-glass	PEL-N-123-00424-00001				0.29	0.25	46	58												
1"	SunDefense IG	PEL-N-123-00435-00001	3	3	argon	0.29	0.22	50	58												
	with grilles-between-the-glass	PEL-N-123-00436-00001				0.29	0.19	44	58												
1"	SunDefense IG	PEL-N-123-00437-00001	4	4	argon	0.29	0.22	50	58												
	with grilles-between-the-glass	PEL-N-123-00438-00001				0.29	0.19	43	58												
1"	SunDefense IG	PEL-N-123-00439-00001	5	5	argon	0.29	0.21	49	58												
	with grilles-between-the-glass	PEL-N-123-00440-00001				0.29	0.19	43	58												
1"	AdvancedComfort Low-E IG	PEL-N-123-00467-00001	3	3	argon	0.25	0.28	53	47						24						
	with grilles-between-the-glass	PEL-N-123-00468-00001				0.25	0.25	46	47					22							
1"	AdvancedComfort Low-E IG	PEL-N-123-00469-00001	4	4	argon	0.25	0.28	52	47					24							
	with grilles-between-the-glass	PEL-N-123-00470-00001				0.25	0.25	46	47					22							
1"	AdvancedComfort Low-E IG	PEL-N-123-00471-00001	5	5	argon	0.25	0.28	52	46					24							
	with grilles-between-the-glass	PEL-N-123-00472-00001				0.25	0.25	45	46					22							
1"	NaturalSun Low-E IG	PEL-N-123-00403-00001	3	3	argon	0.30	0.54	61	58					33							
	with grilles-between-the-glass	PEL-N-123-00404-00001				0.30	0.47	53	58					29							
1"	NaturalSun Low-E IG	PEL-N-123-00405-00001	4	4	argon	0.30	0.52	61	57					32							
	with grilles-between-the-glass	PEL-N-123-00406-00001				0.30	0.46	53	57					28							
1"	NaturalSun Low-E IG	PEL-N-123-00407-00001	5	5	argon	0.30	0.51	60	57					31							
	with grilles-between-the-glass	PEL-N-123-00408-00001				0.30	0.45	52	57					28							

R-Value = 1/U-Factor

SHGC = Solar Heat Gain Coefficient

VLT % = Visible Light Transmission

CR = Condensation Resistance

ER = Canadian Energy Rating

(1) Glazing performance values are calculated based on NFRC 100, NFRC 200 and NFRC 500.

ENERGY STAR® values are updated to 2015 (Version 6) criteria.

(2) The values shown are based on Canada's updated ENERGY STAR® 2015 initiative.

For center-glass values, see the Product Performance section.

See the Product Performance section for more detailed information or visit www.energystar.gov for Energy Star guidelines.

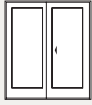

SLIDING PATIO DOOR

GLAZING PERFORMANCE - TOTAL UNIT

High Altitude Glazing



Glass Thickness	Type of Glazing	NFRC Certified Product #	Glass (mm)		Gap Fill	Performance Values ₁				Shaded Areas Meet ENERGY STAR® Performance Criteria in Zones Shown							
			Ext.	Int.		U-Factor	SHGC	VLT %	CR	U. S.				Canada ₂			
										Zone				ER	Zone		
HIGH ALTITUDE GLAZING											N	NC	SC	S	1	2	3
1"	(HA) Advanced Low-E IG	PEL-N-123-00283-00001	3	3	air	0.36	0.29	54	53						11		
	with grilles-between-the-glass	PEL-N-123-00284-00001				0.36	0.26	47	53						9		
1"	(HA) Advanced Low-E IG	PEL-N-123-00285-00001	4	4	air	0.35	0.29	53	53						12		
	with grilles-between-the-glass	PEL-N-123-00286-00001				0.35	0.25	47	53						10		
1"	(HA) Advanced Low-E IG	PEL-N-123-00287-00001	5	5	air	0.35	0.29	53	53						12		
	with grilles-between-the-glass	PEL-N-123-00288-00001				0.35	0.25	46	53						10		
1"	(HA) SunDefense IG	PEL-N-123-00299-00001	3	3	air	0.35	0.22	50	53						8		
	with grilles-between-the-glass	PEL-N-123-00300-00001				0.35	0.19	44	53						6		
1"	(HA) SunDefense IG	PEL-N-123-00301-00001	4	4	air	0.35	0.22	50	53						8		
	with grilles-between-the-glass	PEL-N-123-00302-00001				0.35	0.19	43	53						6		
1"	(HA) SunDefense IG	PEL-N-123-00303-00001	5	5	air	0.35	0.22	49	53						8		
	with grilles-between-the-glass	PEL-N-123-00304-00001				0.35	0.19	43	53						6		
1"	(HA) AdvancedComfort Low-E IG	PEL-N-123-00331-00001	3	3	air	0.30	0.28	53	44						18		
	with grilles-between-the-glass	PEL-N-123-00332-00001				0.30	0.25	46	44						16		
1"	(HA) AdvancedComfort Low-E IG	PEL-N-123-00333-00001	4	4	air	0.29	0.28	52	44						19		
	with grilles-between-the-glass	PEL-N-123-00334-00001				0.29	0.25	46	44						17		
1"	(HA) AdvancedComfort Low-E IG	PEL-N-123-00335-00001	5	5	air	0.29	0.28	52	43						19		
	with grilles-between-the-glass	PEL-N-123-00336-00001				0.29	0.25	45	43						17		
1"	(HA) NaturalSun Low-E IG	PEL-N-123-00267-00001	3	3	air	0.36	0.53	61	53						25		
	with grilles-between-the-glass	PEL-N-123-00268-00001				0.36	0.47	53	53						21		
1"	(HA) NaturalSun Low-E IG	PEL-N-123-00269-00001	4	4	air	0.36	0.52	61	53						24		
	with grilles-between-the-glass	PEL-N-123-00270-00001				0.36	0.46	53	53						21		
1"	(HA) NaturalSun Low-E IG	PEL-N-123-00271-00001	5	5	air	0.36	0.51	60	53						24		
	with grilles-between-the-glass	PEL-N-123-00272-00001				0.36	0.45	52	53						20		
HIGH ALTITUDE GLAZING – WITH FOAM INSULATION											N	NC	SC	S	1	2	3
1"	(HA) Advanced Low-E IG	PEL-N-123-00411-00001	3	3	air	0.33	0.29	54	55						15		
	with grilles-between-the-glass	PEL-N-123-00412-00001				0.33	0.26	47	55						13		
1"	(HA) Advanced Low-E IG	PEL-N-123-00413-00001	4	4	air	0.33	0.29	53	55						15		
	with grilles-between-the-glass	PEL-N-123-00414-00001				0.33	0.25	47	55						12		
1"	(HA) Advanced Low-E IG	PEL-N-123-00415-00001	5	5	air	0.32	0.29	53	55						16		
	with grilles-between-the-glass	PEL-N-123-00416-00001				0.32	0.25	46	55						14		
1"	(HA) SunDefense IG	PEL-N-123-00427-00001	3	3	air	0.33	0.22	50	56						11		
	with grilles-between-the-glass	PEL-N-123-00428-00001				0.33	0.19	44	56						9		
1"	(HA) SunDefense IG	PEL-N-123-00429-00001	4	4	air	0.32	0.22	50	55						12		
	with grilles-between-the-glass	PEL-N-123-00430-00001				0.32	0.19	43	55						10		
1"	(HA) SunDefense IG	PEL-N-123-00431-00001	5	5	air	0.32	0.22	49	55						12		
	with grilles-between-the-glass	PEL-N-123-00432-00001				0.32	0.19	43	55						10		
1"	(HA) AdvancedComfort Low-E IG	PEL-N-123-00459-00001	3	3	air	0.27	0.28	53	44						22		
	with grilles-between-the-glass	PEL-N-123-00460-00001				0.27	0.25	46	44						20		
1"	(HA) AdvancedComfort Low-E IG	PEL-N-123-00461-00001	4	4	air	0.27	0.28	52	44						22		
	with grilles-between-the-glass	PEL-N-123-00462-00001				0.27	0.25	46	44						20		
1"	(HA) AdvancedComfort Low-E IG	PEL-N-123-00463-00001	5	5	air	0.27	0.28	52	43						22		
	with grilles-between-the-glass	PEL-N-123-00464-00001				0.27	0.25	45	43						20		
1"	(HA) NaturalSun Low-E IG	PEL-N-123-00395-00001	3	3	air	0.34	0.53	61	55						27		
	with grilles-between-the-glass	PEL-N-123-00396-00001				0.34	0.47	53	55						24		
1"	(HA) NaturalSun Low-E IG	PEL-N-123-00397-00001	4	4	air	0.34	0.52	61	54						27		
	with grilles-between-the-glass	PEL-N-123-00398-00001				0.34	0.46	53	54						23		
1"	(HA) NaturalSun Low-E IG	PEL-N-123-00399-00001	5	5	air	0.33	0.51	60	54						27		
	with grilles-between-the-glass	PEL-N-123-00400-00001				0.33	0.45	52	54						24		

R-Value = 1/U-Factor
 SHGC = Solar Heat Gain Coefficient
 VLT % = Visible Light Transmission
 CR = Condensation Resistance
 ER = Canadian Energy Rating

Climate Zones

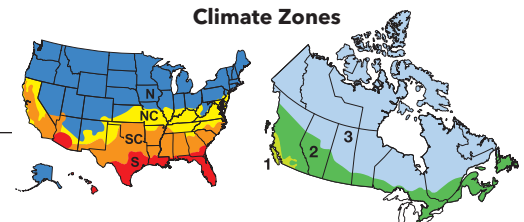

(1) Glazing performance values are calculated based on NFRC 100.
 (2) The values shown are based on Canada's updated ENERGY STAR® initiative.
 For center-glass values, see the Product Performance section.
 See the Product Performance section for more detailed information or visit www.energystar.gov for Energy Star guidelines.

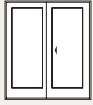

SLIDING PATIO DOOR

PRODUCT PERFORMANCE

Sound Transmission Class and Outdoor-Indoor Transmission Class Combination Assemblies



Product	Frame Size Tested ₁	Glazing System			STC Rating	OITC Rating
		Overall Glazing Thickness	Exterior Glass Thickness	Interior Glass Thickness		
VENT-FIXED	71-1/2" x 79-1/2"	1"	5mm	5mm	29	23
VENT-FIXED	71-1/2" x 79-1/2"	1"	3mm	3mm	28	21

(1) ASTM E 1425 defines standard sizes for acoustical testing. Ratings achieved at that size are representative of all sizes of the same configuration.

Combinations are a great way to create visual interest in any project. A combination is an assembly formed by two or more separate windows or doors whose frames are mullered together by a combination or reinforcing mullion.

Pella door combinations are available in an endless variety of arrangements. Below are some field-assembled combinations. Some units can be fixed or vent depending on availability. See the combinations section, for typical combinations and requirements and limitations related to mulling various units.

Contact your local Pella sales representative for more information.

TRANSOM OVER XO	ARCH HEAD OVER XO	HALF CIRCLE OVER XO	ARCH HEAD OVER FIXED
	FIXED / XO 		



[Click here for the Impervia Combinations Section](#)

- Downloadable PDF file.



SLIDING PATIO DOOR

GRILLE TYPES

Grilles-Between-the-Glass



Grille Profiles

GRILLES-BETWEEN-THE-GLASS

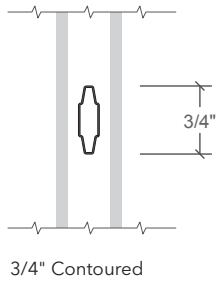

Grille Patterns

PRAIRIE PATTERNS

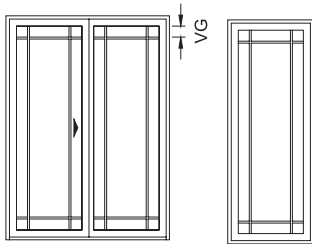

9-Lite Prairie

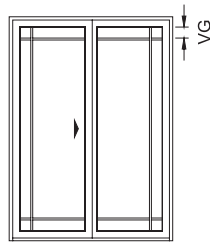

6-Lite Prairie

Standard corner lite dimension for Prairie patterns = 4" visible glass (VG).

Pattern availability may vary depending on size of unit.

ADDITIONAL PATTERNS

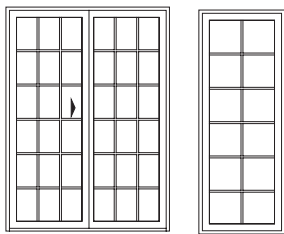

Traditional

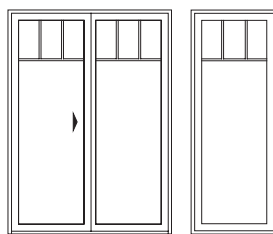

Top Row₁

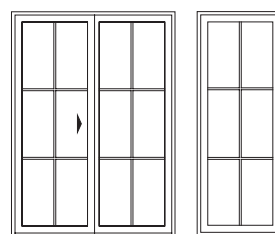

Special

Pattern availability may vary depending on size of unit.

(1) Standard visible glass to center line of separator bar = 14" or half of total visible glass height, whichever is smaller. Multiple rows are available up to 50% glass size.



SLIDING PATIO DOOR

SIZE TABLES

Transoms, Fixed and Vent Units



Transoms

	(1 524) (1 511)	(1 829) (1 816)
Opening	5' 0"	6' 0"
Frame	4' 11 1/2"	5' 11 1/2"
(356) (343)	1' 2"	1' 1 1/2"
(457) (445)	1' 6"	1' 5 1/2"
(610) (597)	2' 0"	1' 11 1/2"
	5-0/1-2	6-0/1-2
	5-0/1-6	6-0/1-6
	5-0/2-0	6-0/2-0

	(810) (797)	(962) (949)	(1 267) (1 254)	(1 524) (1 511)	(1 829) (1 816)	(2 438) (2 426)
Opening	2' 7 7/8"	3' 1 7/8"	4' 1 7/8"	5' 0"	6' 0"	8' 0"
Frame	2' 7 3/8"	3' 1 3/8"	4' 1 3/8"	4' 11 1/2"	5' 11 1/2"	7' 11 1/2"
(2 032) (2 019)	6' 8"	6' 7 1/2"				
(2 063) (2 070)	6' 10"	6' 9 1/2"				
(2 438) (2 426)	8' 0"	7' 11 1/2"				
	FIXED 2-8/6-8	FIXED 3-2/6-8	FIXED 4-2/6-8	VENT-FIXED (XO) * 5-0/6-8	VENT-FIXED (XO) * 6-0/6-8	VENT-FIXED (XO) * 8-0/6-8
	FIXED 2-8/6-10	FIXED 3-2/6-10	FIXED 4-2/6-10	VENT-FIXED (XO) * 5-0/6-10	VENT-FIXED (XO) * 6-0/6-10	VENT-FIXED (XO) * 8-0/6-10
		FIXED 3-2/8-0	FIXED 4-2/8-0		VENT-FIXED (XO) * 6-0/8-0	VENT-FIXED (XO) * 8-0/8-0

Not to scale.

Special sizes available to the nearest 1/4".

All dimensions are approximate to the nearest 1/16"

* Two panel doors-Vent-Fixed (XO), left panel opens, right panel is fixed.

Units open in the direction of the arrows as viewed from the exterior. Fixed-Vent (OX) doors are also available.



DESIGN DATA



SLIDING PATIO DOOR

SLIDING PATIO DOOR DESIGN DATA

Unit	Venting	Clear Opening		Vent Area Ft ²	Visible Glass Ft ²	Standard Glass Thickness (mm)		Performance Class & Grade ^{1,2}
		Width (Inches)	Height (Inches)			Annealed	Tempered	
6'8" DOORS								
2-8/6-8	○	–	–	–	12.0	–	3	LC50
3-2/6-8	○	–	–	–	15.0	–	4	LC50
4-2/6-8	○	–	–	–	21.0	–	4	LC50
5-0/6-8	XO, OX	22-5/16	74-7/8	11.7	24.0	–	3	LC45/LC50
6-0/6-8	XO, OX	28-5/16	74-7/8	14.8	30.0	–	3	LC45/LC50
8-0/6-8	XO, OX	40-5/16	74-7/8	21.0	42.0	–	5	LC30/LC35
6'10" DOORS								
2-8/6-10	○	–	–	–	12.3	–	3	LC50
3-2/6-10	○	–	–	–	15.4	–	4	LC50
4-2/6-10	○	–	–	–	21.6	–	4	LC50
5-0/6-10	XO, OX	22-5/16	76-7/8	12.0	24.6	–	3	LC45/LC50
6-0/6-10	XO, OX	28-5/16	76-7/8	15.2	30.8	–	3	LC45/LC50
8-0/6-10	XO, OX	40-5/16	76-7/8	21.6	43.2	–	5	LC30/LC35
8' DOORS								
3-2/8-0	○	–	–	–	18.3	–	4	LC50
4-2/8-0	○	–	–	–	25.7	–	4	LC50
6-0/8-0	XO, OX	28-5/16	90-7/8	18.0	36.6	–	5	LC30/LC35
8-0/8-0	XO, OX	40-5/16	90-7/8	25.6	51.4	–	5	LC30/LC35
TRANSOMS								
5-0/1-2	–	–	–	–	2.8	3	3	LC50
6-0/1-2	–	–	–	–	3.4	3	3	LC50
5-0/1-6	–	–	–	–	4.2	2.5	3	LC50
6-0/1-6	–	–	–	–	5.2	3	3	LC50
5-0/2-0	–	–	–	–	6.5	2.5	3	LC50
6-0/2-0	–	–	–	–	7.9	2.5	3	LC50

(–) = Not Applicable

(1) Maximum performance when glazed with the appropriate glass thickness.

(2) Second number indicates performance rating with High Performance Retainer.



SLIDING PATIO DOOR

MISCELLANEOUS FORMULAS



Miscellaneous Glass Formulas

	DOORS	TRANSOMS
FRAME	Frame Width = Rough opening width - 1/2" Frame Height = Rough opening height - 1/2"	Frame Width = Rough opening width - 1/2" Frame Height = Rough opening height - 1/2"
PANEL	Width of XO/OX = (Frame width / 2) - 13/16" Width of O = Frame Width - 2-3/8" Panel Height = Frame height - 2-3/16"	Sash Width = Frame width - 2-13/16" Sash Height = Frame height - 2-13/16"
ACTUAL GLASS	Width of XO/OX = (Frame width / 2) - 4-15/16" Width of O = Frame Width - 6-1/2" Glass Height = Frame height - 6-5/16"	Glass Width = Frame width - 5-1/8" Glass Height = Frame height - 5-1/8"
VISIBLE GLASS	Width of XO/OX = (Frame width / 2) - 5-7/8" Width of O = Frame Width - 7-3/8" VG Height = Frame height - 7-3/16"	VG Width = Frame width - 6-1/16" VG Height = Frame height - 6-1/16"
CLEAR OPENING	Clear Opening Width = (Frame width / 2) - 7-7/16" Clear Opening Height = Frame height - 4-9/16"	Not Applicable

Special Size Frame Dimensions

	FRAME WIDTH		FRAME HEIGHT	
	MINIMUM	MAXIMUM	MINIMUM	(MAXIMUM)
VENT DOOR (OX, XO)	47-1/2"	95-1/2"	71-1/2"	95-1/2"
FIXED PANEL (O)	27"	49"	71-1/2"	95-1/2"
TRANSOM	47-1/2"	71-1/2"	13-1/2"	23-1/2"

Frame dimensions are on the nearest 1/4" increment.

Doors that are less than or equal to 54-3/4" in width do not meet 20" egress requirements.



SLIDING PATIO DOOR

DETAILED PRODUCT DESCRIPTIONS



FRAME

- Frame is Duracast® fiberglass composite – five-layer pultruded fiberglass material [with optional foam insulation¹] reinforced with a Pella patented interlocking mat.
- Overall frame depth is 4-3/4".
- Nominal wall thickness of Duracast members are .070" to .120" thick.
- Duracast sill powder-coat painted brown with an oak threshold.
- Frame corners are mitered, joined and bonded with nylon corner lock and mechanically fastened. Jamb to head corners sealed with injected polyurethane adhesive.
- Jambs and head contain factory-drilled (counter-bored) installation screw holes when ordered without nail fin.

DOOR PANEL

- Panel is Duracast® fiberglass composite – five-layer pultruded fiberglass material [with optional foam insulation¹] reinforced with a Pella patented interlocking mat.
- All panel members have mitered corners joined and bonded with corner locks, injected with polyurethane adhesive.
- Vent panels have two adjustable permanently-sealed electroplated steel with organic coating ball-bearing rollers, set on stainless steel track.

EXTERIOR / INTERIOR

- Duracast surfaces are factory applied with powder-coat paint finish.
 - Color is [White] [Tan] [Brown] [Black] [Morning Sky Gray].
 - or -
 - Dual-color option [Tan] [Brown] [Black] [Morning Sky Gray] exterior with White interior.

GLAZING SYSTEM

- Quality float glass complying with ASTM C 1036.
- 1" insulating glass tempered [obscure²] [[clear] [Advanced] [SunDefense™] [AdvancedComfort] [NaturalSun] Low-E coated, with argon]] sealed and bonded to panel.
- High altitude glazing is available.

WEATHERSTRIPPING

- Flexible polymeric bulb section with welded corners and a slip-coating at head, jamb, sill and interlocker.
- Bristle strip rain-screen at vent panel interlocker.

HARDWARE

- Interior handle, thumb lock for inside locking is [powder-coat painted [White] [Tan] [Brown] [Black] [Morning Sky Gray] to match finish] [Satin Nickel] [Bright Brass] [Antique Brass] [Oil-Rubbed Bronze] [Chrome].
- Exterior handle is powder-coat painted to match exterior.
- Non Self-locking Foot Bolt. Finish on Black, Brown and Morning Sky Gray interior units is Brown. Finish on Tan interior units is Tan, and Finish on White interior units is White. Foot bolt holds the door open approximately 3" for ventilation.

OPTIONAL PRODUCTS

Screens

- Conventional Black Fiberglass
 - Black vinyl coated 18/16 mesh fiberglass screen cloth complying with ASTM D 3656 and SMA 1201.
 - Set in aluminum frame and fitted to the inside of door.
 - Supplied complete with all necessary hardware.
 - Screen finish is baked enamel, color to match sliding door interior.

- or -

InView™ screen

- Vinyl-coated 18/18 mesh fiberglass screen cloth complying with SMA 1201, set in aluminum frame fitted to inside of door, supplied complete with all necessary hardware.
- Set in aluminum frame and fitted to the inside of door.
- Supplied complete with all necessary hardware.
- Screen finish is baked enamel, color to match sliding door interior.

Grilles

- Grilles-Between-the-Glass
 - Insulating glass contains 3/4" contoured aluminum grilles permanently installed between two panes of glass.
 - Grilles are factory prefinished [White] [Tan] [Brown] [Black] [Morning Sky Gray] to match interior and exterior finish.

Hardware

- Keylock
 - Schlage® configured alike or random; finish is [White] [Tan] [Brown] [Black] [Morning Sky Gray].

FOAM INSULATION INSERTS, 1

Sliding Patio Door

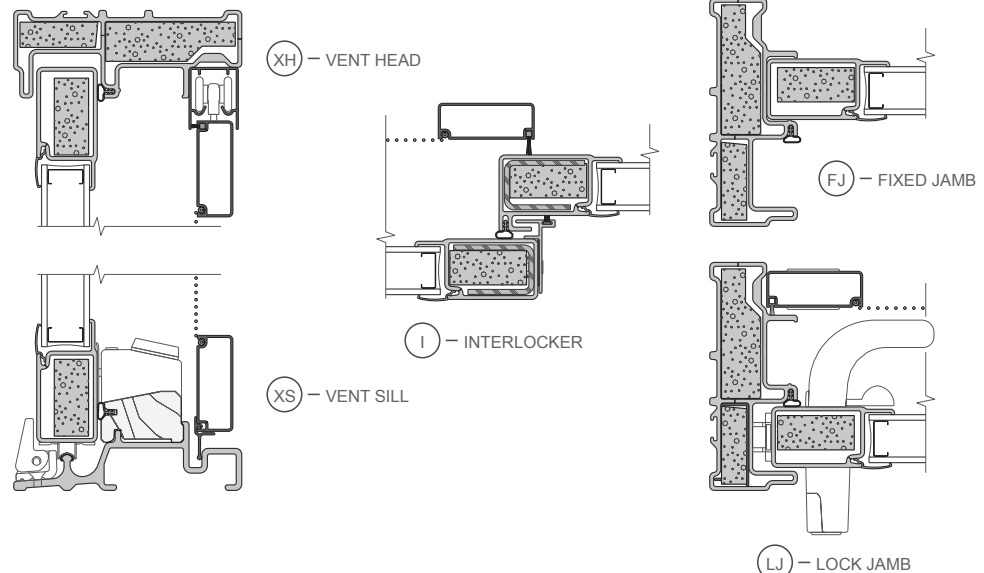

(1) Foam insulation inserts are not available with clear glazing.

(2) Obscure glazing is not available when AdvancedComfort Low-E coated IG is specified.

Schlage® is a registered trademark of Schlage Lock Company.



SLIDING PATIO DOOR

UNIT SECTIONS

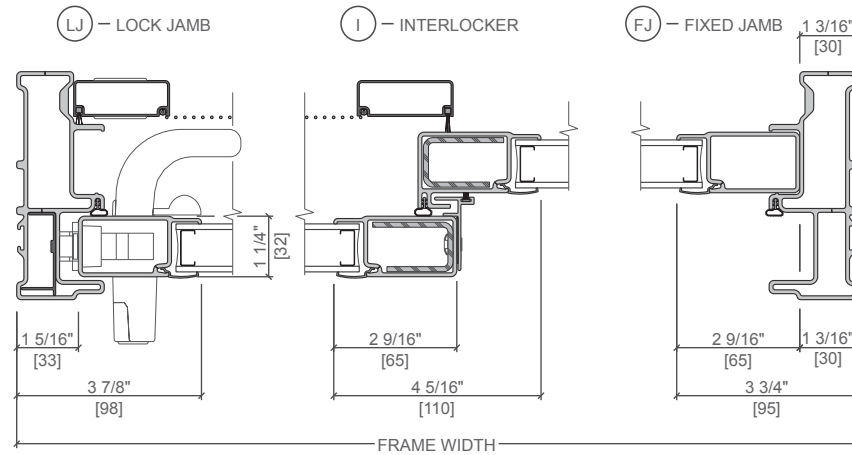
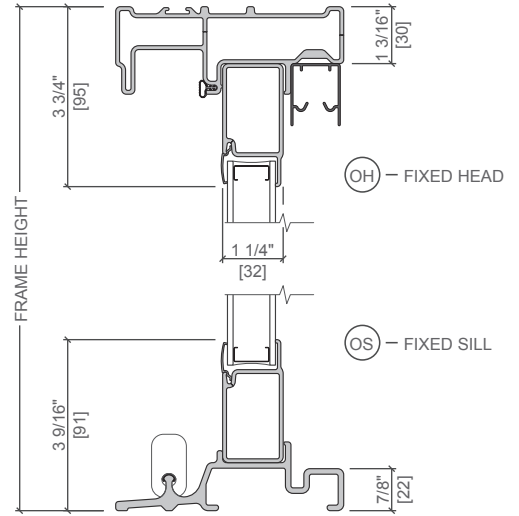
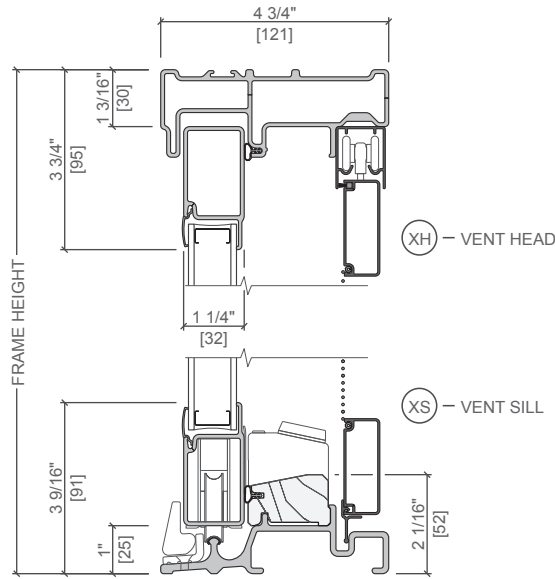
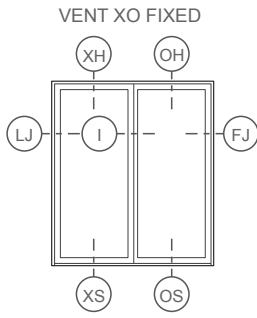

Scale 3" = 1' 0"
All dimensions are approximate.

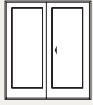

SLIDING PATIO DOOR

UNIT SECTIONS



TRANSOM

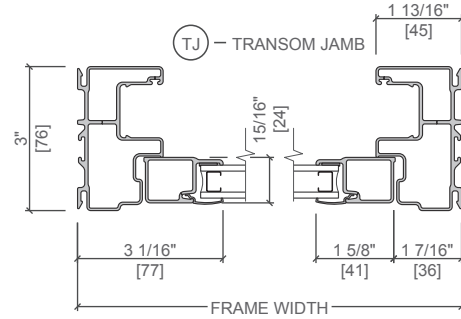
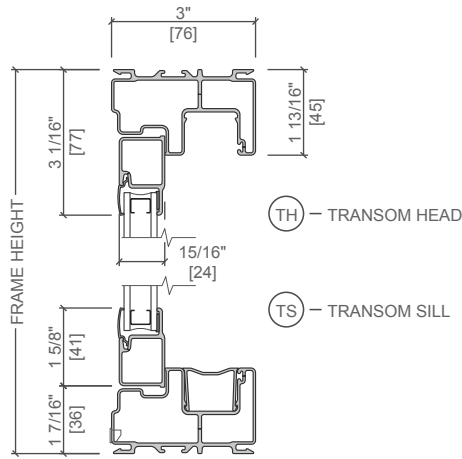
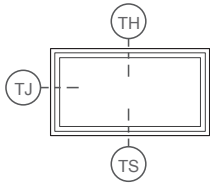

SIDE LIGHT

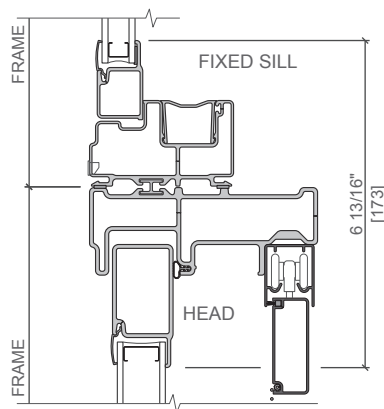
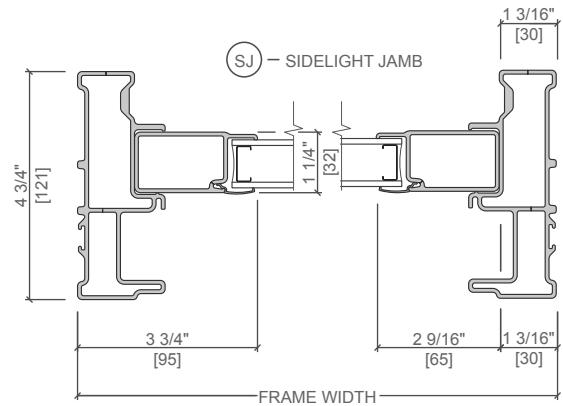
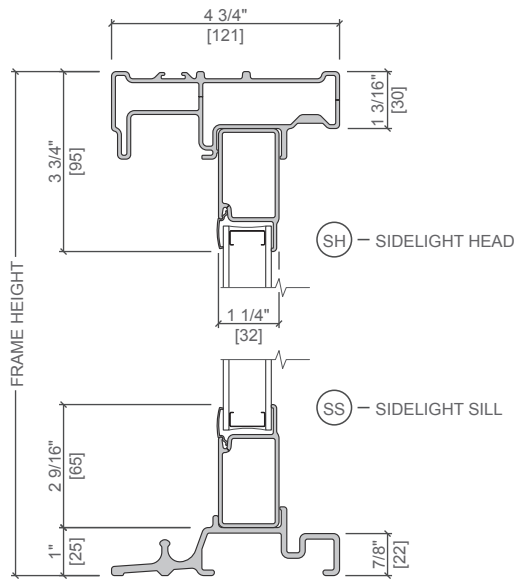
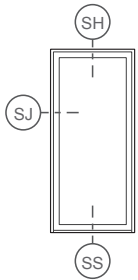

JOINING MULLION WITH TAPE (Horizontal Only)

Scale 3" = 1' 0"
All dimensions are approximate.