



**PRODUCT NAME**

Aquasurf® Solid Surface Products

**PRODUCT DEFINITION**

Aquasurf® Solid Surfacing Products are a homogeneous blend of resins, mineral filler and colorant manufactured for panels, molded and/or shaped products and components.

Aquasurf® Solid Surfacing Products and components provide a luxurious appearance with the sensible durability of stain, impact, burn resistance, and ease of maintenance and cleaning.

**MANUFACTURER**

Aquasurf® Solid Surface Products  
Willoughby Industries, Inc.  
2210 West Morris St.  
Indianapolis, IN. 46221

Phone: (317) 638-2381

Fax: (317) 638-6110

Toll: 1-800-428-4065

Web: [www.willoughby-ind.com](http://www.willoughby-ind.com)

**PRODUCT DESCRIPTION**

Aquasurf® Solid Surfacing Products are manufactured cast polymers, densified solid surface material composed of polyester/acrylic resin, UV stabilizer, Aluminum Trihydrate, mineral fillers, and proprietary colorants.

Aquasurf® Solid Surfacing Products, are completely non-porous, homogeneous components with color consistency throughout. The composite polymers and mineral filler aid in stain, burn, and impact resistance, while enhancing long term durability and cleaning.

**Standard Products:**

Aquasurf® Shower Receptacle

Aquasurf® Tub/Shower Walls

Aquasurf® Solid Surface Products, Shower Receptacle, Wall Panels expand the Commercial and Institutional product availability for Schools, Universities, and Hospitals. These products provide attractive, easily maintained integrated vertical surfacing solutions for Showers, Elevators, Toilet/Shower Partitions, and Vertical Wet Walls applications.

The inherent properties of Aquasurf® Solid Surface Products allow the designer specifier complete confidence of resistance to potentially damaging chemical agents, abuse and vandalism.

**Basic Limitations:**

Aquasurf® Solid Surface Products and components are designed for interior and exterior use. Do not specify or use Aquasurf® components and products where common sense would dictate it is unsafe or environmentally unfriendly, to the standard performance of any Solid Surface product.

Aquasurf® Solid Surface Products should not be specified for use in below grade applications. Special considerations should be made for wet wall applications, or where moisture might be trapped behind panels. Design applications must consider extreme temperature contrasts that might affect the performance, and characteristics.

Aquasurf® Solid Surface Products are engineered to resist most commercial chemical agents, although extremely caustic chemicals, environmentally harmful solvents may cause undesirable effects. The extent of damage and salvage or reparability depends on length of contact.

## PRODUCTS

### Aquasurf® Shower Receptacle

Aquasurf® Shower Receptacle assembly to be monolithic cast solid surface resin matrix. Receptacle assembly to have a nominal ½" thickness throughout, including threshold, curb, and pan to drain. Integral thickened support ribs and foot assembly, and slope to drain thickness not less than ½" at flange. Floor shall have a molded texture. Integral perimeter curb, and threshold. Curb and threshold shall be covered to receptacle base. Perimeter curb shall have a coved integral splash flange. Receptacle base units may be gang assembled, using a seamed transition strip, installed in a rabbit joint. Transition spacer strip may be factory installed. Drain flange is designed to accommodate Jones # 140C or equal.

### Aquasurf® Tub/Shower Walls

Aquasurf® Tub/Shower Wall components to be cast panels, 3/8" or ¼' thick, Nominal 32", 36", or 48" wide. Heights available 60", 72", 84", 96". Components create a unitized shower enclosure system. Coved corner overlay component, with nominal ½' thickness and rabbited returns.

Design/Specifications independently available.

## ASSEMBLY, INSTALLATION, FABRICATION

Aquasurf® Solid Surface Products provides detailed assembly and installation diagrams for all premanufactured components. Required assembly/installation sheet should accompany specified product.

### Aquasurf® Shower Receptacle

Floor area of installation shall be level, with adjoining wall, and plumb. Recess alcove walls and floor surfaces shall be clean. Verification of drain pipe stub up centers and height for final installation of "No Caulk" drain assembly is critical. Installations of drain assembly to Shower Receptacle shall utilize Plumbers Putty (sealant) to maintain leak proof attachment. Shower Receptacle shall be set in "Thin Set" leveling grout. Allows for unevenness of floor surfaces and future settling. Provides for cushioned adhesive contact between surfaces. Shower Receptacle installation completion to include. Attachment of drain stub up caulking gasket. Screw-in flange and drain screen. Test Receptacle base for leaks around perimeter curb, threshold, transition strips (if applicable), and drain assembly attachment. Completion of installation shall include application of protective barrier to limit surface exposure of Receptacle to construction debris, and damages to textured surfaces during wall installation. Shower Receptacle is designed to allow WALL SURFACING materials a landed surface unto the curb within the receptacle. This assists with providing a double sealed leak proof installation.

### Aquasurf® Tub/Shower Walls

Inspect and verify existing mounting wall conditions. Existing wall shall be smooth and plumb, free of surface irregularities.

Preferred wall surface is a primed MR (Moisture Resistant) Drywall Surface, mounted to Wood and/or Metal Stud framework.

Masonry and/or Plaster & Lath wall surfaces shall be plumb, and free of surface irregularities. Wall Surfacing Panels shall be cut to size, square, and plumb with a Carbide Bit within a Router whenever practicable, following a straightedge.

Cut panels should allow for expansion minimum of 1/8" in 10' length (1/4" preferred). Cut outs for fixtures, fittings, and accessories shall be router cut using carbide tipped bit.

Any field cut outs requiring a right or modified angle shall be cut within a radius corner template.

Wall panel installation shall proceed utilizing a permanently flexible adhesive, (Urethane or Silicone).

All trim, battens, jamb trim (as required, specified, and/or applicable), shall be attached with flexible adhesives.

Exposed Joints shall be caulked with Silicone type adhesive and sealant.

Wall surface expansion joints, specified and/or required shall be 1/8" wide butt joints, router cut, mirror matched, and filled with Silicone. Battens shall only be used if decorative application is specified.

Shower wall compartment joints to be 1/8" wide right angle butt joints, filled with Silicone type sealant.

8. All inside/outside corner overlay components shall allow for expansion, protect mated edge surface and be filled with Silicone type sealant.

Any required cut out in a deck assembly, wall or partition panel should be made with a router within a specified template. This provides a smooth transitional cut without rough irregular edges.

To compensate for dimensional movement and prevent stress cracking allow a minimum of 1/8" clearance per ten feet at each end of an alcove installation. A minimum of 1/8" to recommended 1/4" is required at cut out areas, which allow for a drop-in component or fixture. A permanently flexible adhesive

(Silicone or Urethane supplied by others) is recommended for all caulked joints.

Fastening bolts and/or screws may not be directly inserted into any Aquasurf® Solid Surface component. Should a fastening assembly be required, a counter drilled hole designed for a brass insert should be made, allowing for the fastener attachment. If an attachment screw must penetrate the surface of a component or panel, the hole shall be oversized and filled with a flexible adhesive before final assembly. This will allow for adequate movement of component, limiting stress.

#### Sealant and Adhesives:

Aquasurf® Solid Surface Products are compatible with many commercially available caulking compounds. It is recommended any adhesive or sealant is permanently flexible. Proper adhesion and sealant materials are either Silicone or Urethane types. Bracing and/or clamping may be required during the curing times when using these types of adhesives and sealants.

Vertical surface applications require the substrate be clean, free of contaminants, smooth and level. Adhesive should be uniformly applied to bonding surfaces, following manufacturer's recommendations for spread, adherence, bracing, and cure characteristics.

#### MATERIALS AND FINISHES

Aquasurf® Solid Surface Products are premanufactured with a semi-gloss matte appearance.

Components that require fabrication jointing may affect the original factory finish as supplied by Aquasurf® Solid Surface Products. A stepped process of light surface sanding and final application of a medium grade steel wool can renew the original finish. Restoration of the original finish due to improper handling, abuses during installation can similarly be made.

Aquasurf® Solid Surface Products are a mineral filled material, with engineered resin and pigments. Some slight color variation may exist from one component to another, such as two adjoining lavatory, kitchen, or laboratory deck, or adjacent molded component, such as a washfountain or lavatory.

#### WARRANTY

Willoughby Industries, Inc. warrants to commercial and institutional purchasers only that each unit will be free from defects in workmanship and materials under normal use and service upon the following terms and conditions.

The period during which Aquasurf® components are warranted as follows:

Aquasurf® solid surface components are warranted for 2 years from date of shipment.

All other components warranted for 1 year from date of shipment.

This warranty does not cover installation or any other labor charges and does not apply to any components damaged by accident, abuse, improper installation or improper maintenance.

This warranty does not cover any installation that did not comply with national, state and local building, plumbing, or electrical codes.

The warranty is limited to replacing or repairing at out option, transportation charges prepaid by the purchaser, any Aquasurf® component or part which upon our inspection shall be deemed as defective within the limitations of this warranty.

The replacement or repair of defective units as stated in this warranty shall constitute the sole remedy of the purchaser and the sole liability of Willoughby Industries, Inc. Willoughby Industries, Inc. shall not other wise be liable under any indirect damages caused by defects in the repair or replacement thereof.

This warranty only extends to commercial and institutional purchasers and does not extend to any others, including consumer customers of commercial institutional purchasers.

This warranty is in lieu of all other warranties, expressed or implied, including implied warranty

of merchantability or fitness for a particular purpose or otherwise.

#### CARE AND MAINTENANCE

Aquasurf® surfaces may be easily cleaned using conventional cleaning agents such as ammonia based liquid cleaner (glass cleaner).

Dry stains on a matte finish can be removed with a 3M Scotch-Brite gray scouring pad or a mild abrasive cleaner.

Burns or scorches can be removed by sanding with coarse grit sandpaper followed by finer grit (220) sandpaper. Follow sanding with a 3M Scotch-Brite gray pad (or equivalent) to match finish of sanding area to surrounding area. A final buffing may be required on polished surfaces. Accidental nicks or chips can be repaired with special patch kits available in all Aquasurf® colors.

Avoid exposing Aquasurf® surfaces to strong chemicals such as acetone, paint removers and sulfuric acid or hydrochloric chemical cleaners. Exposure to strong chemicals may result in permanent damage to Aquasurf® surfaces.



## Installation of Aquasurf® Solid Surface Products

### Shower Wall Kit and Trim Accessories

#### Installation Precautions:

Before installing Solid Surface shower walls, additional recommendations should be followed to insure a sound, long lasting installation:

- Wall surface should be smooth and plumb, free of surface irregularities.
- Wall Panels should not be installed, nor directly applied to Masonry surfaces.
- Preferred wall surface is a primed MR (Moisture Resistant) drywall surface.

*Allow minimum 1/8" expansion allowances.*

#### Specifications and Layout

Whether new construction or renovation verify that plumbing valves and water-resistant gypsum board has been installed.

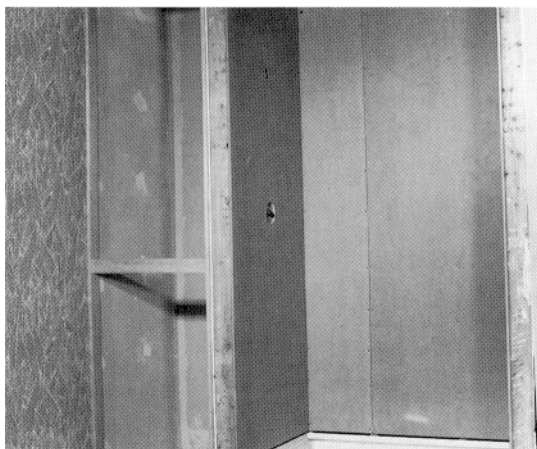

*Shower pan, plumbing and wallboard installed*

#### Standard Components

Aquasurf® Solid Surface Products Shower Wall Kits are easily installed. Little fabrication is required. The Shower Kit consists of precut 3/8" or 1/4" sheets 36" x 72" or 84", precut 3/8" or 1/4" sheets 29" x 72" or 84", plus a 3/8" or 1/4" batten strip 2" x 72" or 84".

The optional AS-ISCR 4" Inside Corner Overlay, or AS-IS-CV 1" x 1" with 3/4" Inside Cove provides a deluxe, finished appearance to the installation.

#### SHOWER RECEPTACLE

AS-S36NEO	36" x 36" Neo-Angle Integral Shower Receptacle
AS-S36RND	36" x 36" Round Integral Shower Receptacle

AS-S3840-FA	36" x 36" <b>ADA</b> Integral Trench Drain Transfer Receptacle
AS-S3462-FA	34" x 60" <b>ADA</b> Integral Trench Drain Transfer Receptacle

AS-S3636	36" x 36" Integral Shower Receptacle
AS-S4836	48" x 36" Integral Shower Receptacle
AS-S6036	60" x 36" Integral Shower Receptacle
AS-B0272	3/8" x 2" x 72" Batten Trim
AS-P4896	3/8" x 48" x 96" Wall Panel ( <b>per square foot</b> )

#### SHOWER WALL KITS

ASK-NEO	2- 3/8" 36" x 72" Shower Wall Panel (NEO)
ASK-RND	2- 3/8" 36" x 72" Shower Wall Panel (RND)
ASK-S363672	3 - 3/8" 36" x 72" Shower Wall Panel
ASK-S483672	2 - 3/8" x 36" x 72" Shower Wall Panel 1 - 3/8" x 48" x 72" Shower Wall Panel
ASK-S603672	2 - 3/8" x 36" x 72" Shower Wall Panel 2 - 3/8" x 29" x 72" Shower Wall Panel 1 - AS-B0272 Batten Trim
ASK-S603684.25	2 - 1/4" x 36" x 84" Shower Wall Panel 2 - 1/4" x 29" x 84" Shower Wall Panel 1 - ASB-0284.25 Batten Trim
ASK-S363684.25	3 - 1/4" x 36" x 84" Shower Wall Panel

AS-ISCR	Inside Corner Overlay Trim (Coved Corner)
AS-IS-CV8	3/4" Inside Corner (Coved) 1 1/4" x 1 1/4"

Commercial adhesives such as Bostik 1100FS Urethane adhesive for attachment and commercial grade clear and/or color matched silicone caulk should be used for caulking joints, battens and trim strips to provide a watertight seal.

## Planning and Preparation

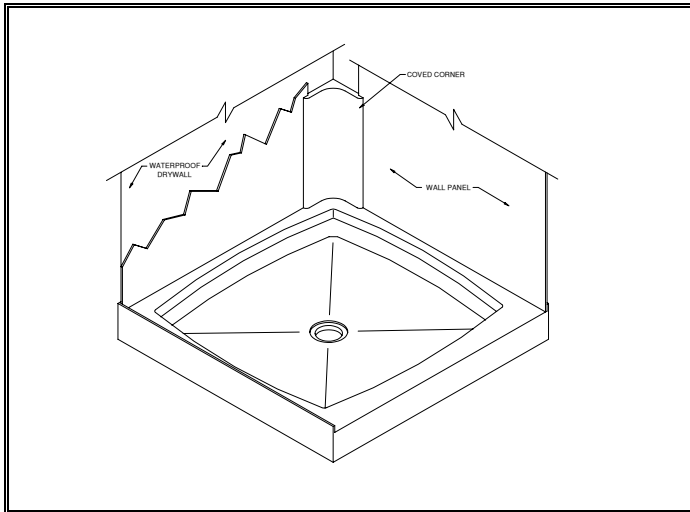

Aquasurf® Solid Surface Products Shower Wall Kit

Wall Panel Kits can be upgraded to 96" height and substituted for the pre-cut Shower Kits, particularly for customized or non-standard tub installations.

A Commercial Wall Panel Kit substituting 1/4" thickness is also available. Consult your wholesale supplier or factory for the 1/4" specification.

### Optional:

- AS-SSH Soap/Shampoo Holder

Scotch-Brite® wiping pads are used to clean the Aquasurf® Solid Surface Products Tub Wall Kit surface after installation.

Prepare a drawing as illustrated as a reference for ordering materials.

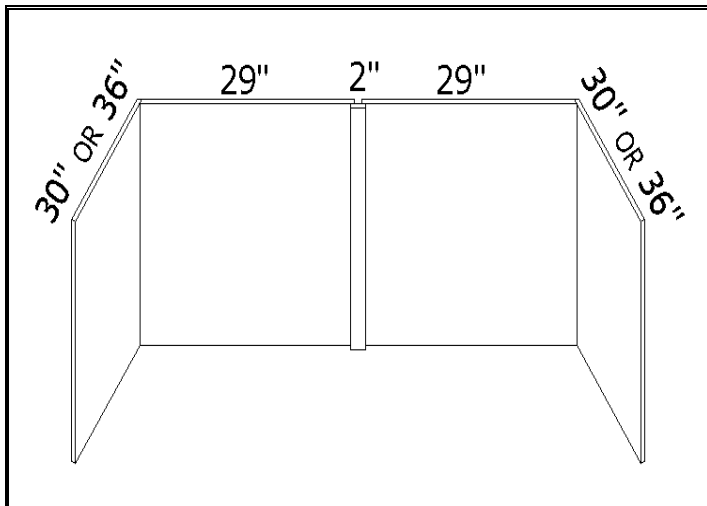

## Ordering Materials

Consult previous chart for available components.

We suggest you make a "list of materials" you will need:

Bostik 1100FS Adhesive and Silicone Caulking materials.  
Scotch-Brite Wiping Pads-to clean the Solid Surface

## Installation Tools and Supplies

The following tools and supplies are recommended, to install a tub kit:

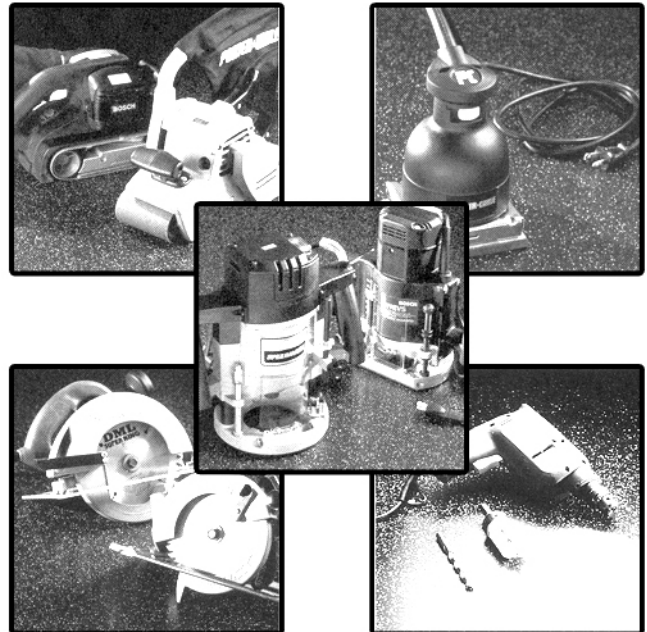

### Power Tools: \*

- 1/2" Electric Drill, 1/2" Drill Bits, 1" Hole Saw
- Circular Saw with Carbide Tipped Saw Blades
- Belt Sander with 80 to 120 grit papers
- Router, 1/2" shank carbide bits, straightedge

### Accessory tools:

- Caulking gun
- Saw horses and three 2" x 4" X 8' support rails

- ❑ Ordinary carpenter tools including file, scribe or pencil, compass, square, level, tape measure, hammer, nails, shims, extension cord, etc.
- ❑ Clean-up tools and supplies including masking tape, putty knife or caulk remover tool, denatured alcohol, wiping cloth, etc.
- ❑ Blanket, padding or commercially available tub protector, to protect tub from scratches
- ❑ Additional tools and supplies listed below are not required but can make the job easier and reduce installation time.
- ❑ Random Orbital (vibrating) sander.
- ❑ 1" x 1", or 1" x 2" wood bracing strips for wall panels.

***Always wear, safety glasses when working with power tools.***

### **Handling and Delivery to Job**

We recommend wearing gloves when handling large sheets of Solid Surface materials to protect against cuts from sharp edges.

Before loading your truck, inspect and make sure Solid Surface sheets match and are in good condition.

Use a soft material such as carpeting or a blanket to protect the sheet and especially the edges from damage during delivery. Interleaf sheets with paper or cardboard to protect surfaces.

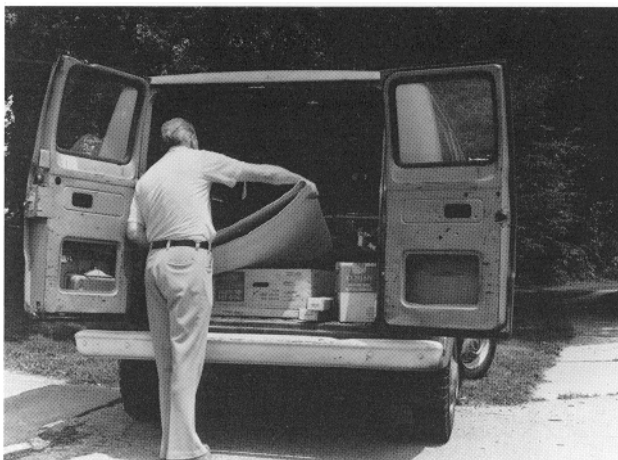

*Protect Shower Kit materials during delivery*

### **Wall Preparation**

Cover the shower pan and wall panels with padding or a blanket to protect against damage and scratches.

Verify the drywall materials installed provides ½" spacing between the bottom edge of the wallboard and the shower pan flange. If not, cut the wallboard with a utility knife to provide this gap.



*Check ½" spacing*

If specified, locate recessed soap dish position on the wall and cut an opening in the wallboard avoiding studs locations.

Wipe down the wallboard with an alcohol moistened cloth to remove dust which may affect adhesive bonding.



*Make soap dish opening*

### **Shower Wall Kit Installation**

#### **Install Ceiling (if applicable)**

Measure ceiling. A typical installation may require single or two ceiling panels with a center batten strip.



Measure ceiling

Place an **optionally** ordered sheet face up on the 2" x 4" support rails. Before cutting sheet, always inspect the face of the sheet. Mark the dimensions and clamp a straight edge to the sheet as a cutting guide.

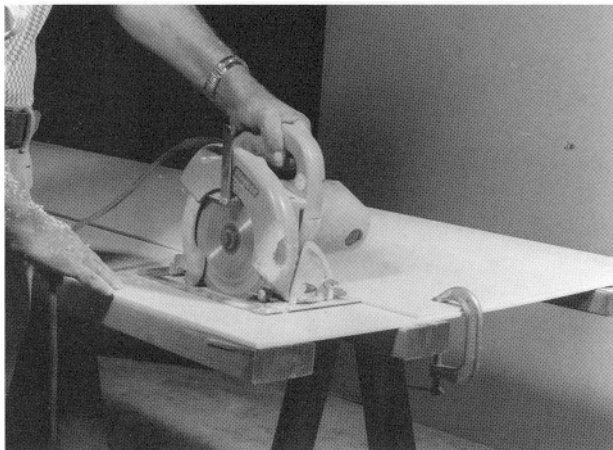

Support Solid Surface sheet with 2" x 4" rail

Rip a batten strip using a circular saw. Save strip for future use on two panel ceiling installation. Now cut the single or two ceiling panels and the ceiling batten.

Always use the third 2" x 4" rail to support the area being cut. The circular saw blade should be set to penetrate about 1/4" through the sheet material.

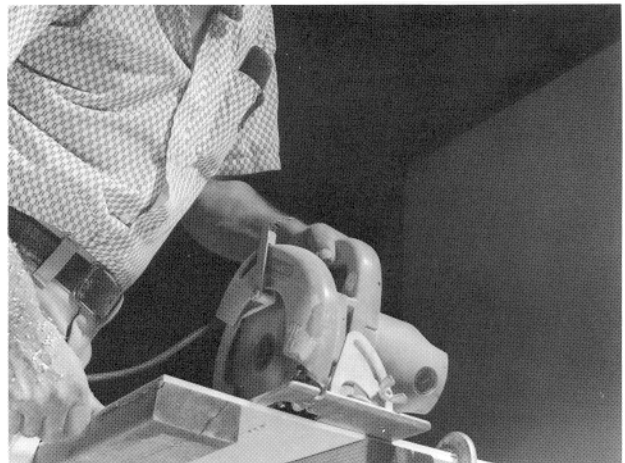

Saw blade should barely penetrate the Solid Surface material

Install ceiling panels using standard panel installation procedures. However, in the case of a ceiling, it is easier to apply the adhesive to the back of the sheet rather than to the ceiling. The ceiling batten will be installed later, if two-panel design requires.



Apply adhesive to ceiling panels



Cut and install ceiling panels



To hold the ceiling panels in place until the adhesive sets, tack a few nails into the drywall immediately below and alongside the panels. An alternate tacking procedure uses hot melt adhesive, which is ideal for ceilings. Cutting and use of 1" x 1" vertical bracing is also recommended.

### **Install First Side Panel**

If design specifies, a full 30" or 36" wide sidewall panel can be installed onto a plumb wall surface. Start with the panel on the sidewall with the plumbing outlets. (If in your design, sheet is not full ceiling height, locate lowest point on pan ledge for first sheet installation.) Measure the floor to ceiling height and cut sheet to correct length.

With shims in place, measure and mark the location of the plumbing outlets on the face side of the sheet. Make the cutout holes 1/4" larger than required for the plumbing.

Make a starter hole with the drill and complete the cutout with a hole saw. Be sure to support the sheet on the 2" x 4" when cutting holes. File all cutout edges and corners. It is recommended that a router with carbide bit be used within a template for large cutouts executed within wall panels, and sheet materials.



*Cut plumbing holes*



*Use 1/16" shims between sidewall sheet and pan*



After completing the cutouts, file front and back edges smooth, and install the panel, following standard installation procedures.

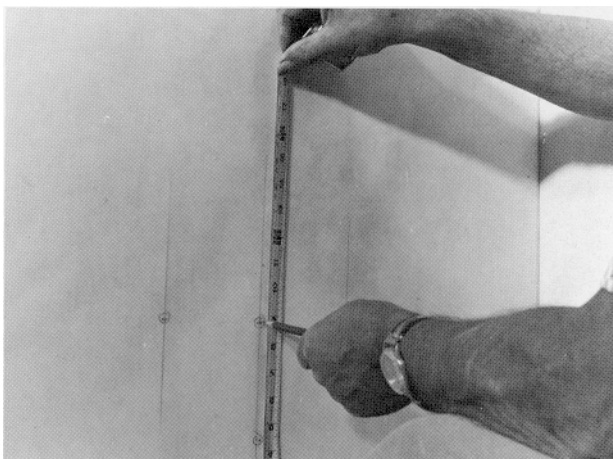

*Locate plumbing outlets*

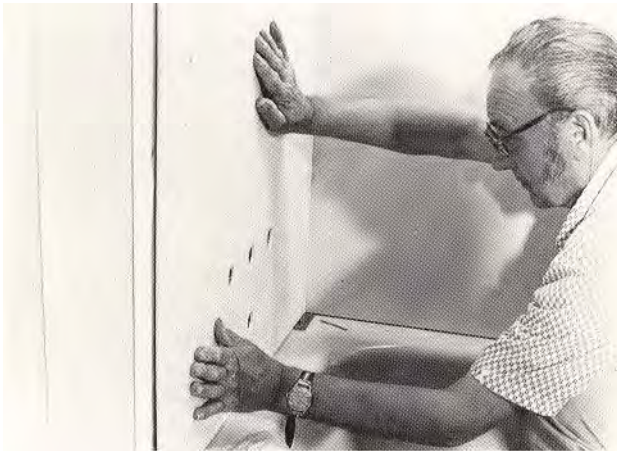

*Install panel over plumbing outlets*

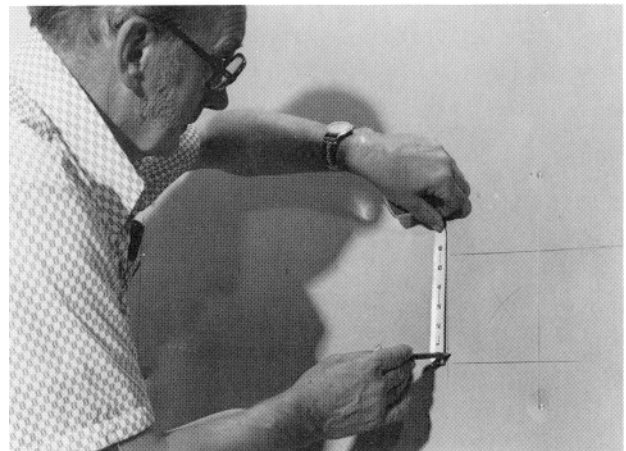

*Locate soap dish*



*Install side panel*

### **Install Second Side Panel**

Install the second sidewall panel on the opposite wall following the standard procedures

Next, if an optional recessed soap/shampoo holder is specified, locate the position on the wall. Cut an opening in the drywall board avoiding stud locations. If grab bars are specified, check the design to make sure they can be anchored to the properly located studding.

If a recessed soap dish is specified within this panel, the cutout should be made. Check the exact location of the soap dish by measuring the opening in the drywall and transfer those dimensions to the front side of the back wall sheet material.

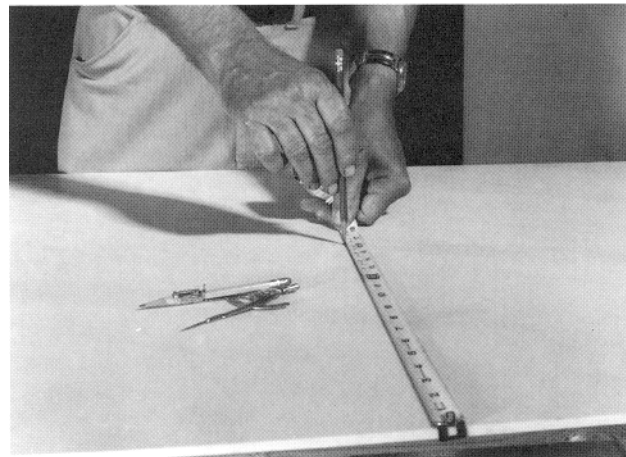

*Locate soap dish cutout on panel*

### **Install Rear Panel**

Cut the sheet to the correct length and width for the back wall panel. Measure position for the soap dish and make cutout as described above.

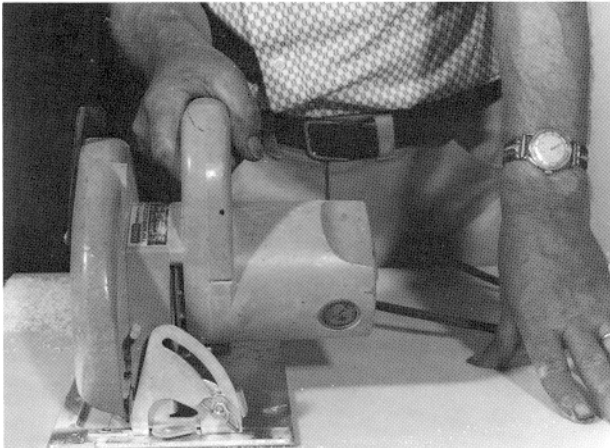

*Cut rear panels to correct length and width*

Install panel, scribing and trimming as necessary.  
Be sure to leave a 1/16" gap in the corner for Caulking.

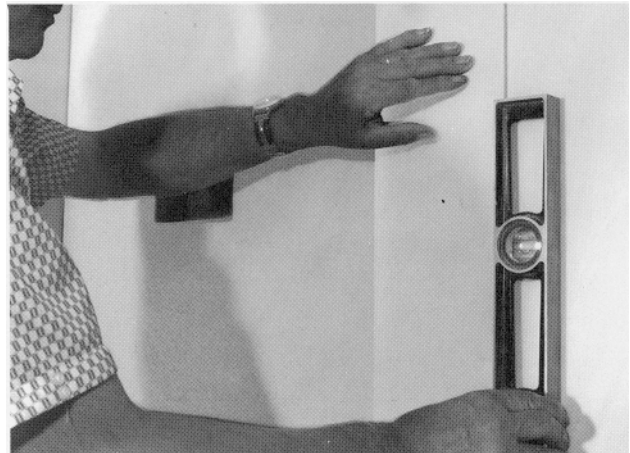

*Install rear wall batten*



*Leave 1/8" gap in corners for caulking*

### **Installation of (2) Panel Rear Wall**

The 60" shower receptacle requires use of (2) panels for rear wall. The precut Shower Kit provides (2) 29" x 72", 84" or optional 96" sheet materials. Cut and scribe the sheet to length and width as required for the right and left rear panels. Install as above. Verify a minimum of 1" space between rear wall panels to allow for expansion.

### **Install Rear Wall Center Batten**

Take the 2" batten strip, trial fit and cut to length. Install the batten on the rear wall. The batten should overlap the sheets at least 1/2" on either side.

## **Aquasurf® Solid Surface Products**

### **Shower Wall Kit Optional Trim**

Aquasurf® Solid Surface Products offers an expanding line of optional trim accessories including inside corner trim and perimeter edge casing trim. Consult the Wholesale or Factory representative to secure materials.

### **Install Side Wall Casing Trim**

To complete the sidewall installation, first cut trim to size creating a picture frame perimeter. Use panel adhesive to adhere the premanufactured casing. Attach to sidewall panel and adjacent drywall surfaces.

### **Install Ceiling Trim**

The optional casing strips can be installed along the top edge of the wall panel sheets against the ceiling on all four walls. Cut the trim strips to length leaving a 1/16" space in the corners for caulking.

Apply a bead of adhesive to the back of the strips and press in place.



*Install ceiling trim*



*Install casing strips*

The front edge of the casing strip should be flush with the front edge of the gypsum board.

Follow this same procedure for all the side, rear wall casing strips.



*Install casing strips*

### **Install Ceiling Batten (if applicable)**

The ceiling batten should be trial fit and trimmed leaving 1/16" space for caulk at front and rear edges. Round the edges by sanding. Install using the same procedures as with the rear wall batten. Brace if necessary until adhesive sets.



*Install ceiling batten*

### **Install Aquasurf® Corner Trim**

AS-ISCR	Inside Corner Overlay Trim (Coved Corner)
AS-IS-CV8	¾" Inside Corner (Coved) 1 1/4" x 1 1/4"

Aquasurf® Corner Trim is optionally available for final trim and finish. Trial fit and scribe as required to exactly match the vertical corners. Install the trim strips using both silicone sealant and panel adhesive. The custom shower installation is now complete except for cleaning and caulking.



*Install Corner trim*

### **Final Cleanup and Caulking**

Install fixtures, soap dishes, shower doors, etc. Carefully clean up and caulk following previously described procedures



*Caulk all joints, corners and edges*



### **CARE AND MAINTENANCE**

Aquasurf® Solid Surface Products may be easily cleaned using conventional cleaning agents such as ammonia based liquid cleaner, (glass cleaner).

Dry stains on a matte finish can be removed with a 3M Scotch-Brite gray scouring pad or a mild abrasive cleaner.

Burns or scorches can be removed by sanding with coarse grit sandpaper followed by finer grit (220) sandpaper. Follow sanding with a 3M Scotch-Brite gray pad (or equivalent) to match finish of sanded area to surrounding area. A final buffing may be required on polished surfaces. Accidental nicks or chips can be repaired with special patch kits available in all Aquasurf® colors.

Avoid exposing Aquasurf® surfaces to strong chemicals such as acetone; paint removers, and sulfuric acid or hydrochloric chemical cleaners. **Prolonged exposure to strong chemicals may result in permanent damage to Aquasurf® surfaces.**

# Aquasurf® Solid Surface

## Shower Wall Systems

