

Beautiful, Durable,
Renewable Bamboo®



Teragren®

FINE BAMBOO FLOORING, PANELS & VENEER

Beauty/Durability/Renewability: The Teragren Difference

STUDIO flat grain Caramelized

Since 1994 we have directly controlled manufacturing—and product quality—from harvest to distribution. These products, created with rapidly renewable bamboo, offer a beautiful and environmentally responsible alternative to precious rainforest hardwoods. Bamboo also absorbs more carbon than a comparable hardwood forest, reducing CO2 levels that lead to climate change.

SUPERIOR PRODUCT QUALITY

- Proprietary and precise manufacturing methods
- Teragren's Xcora™ technology – best in bamboo engineering with state-of-the-art equipment
- Expands and contracts less than many hardwoods
- Hard and durable—our Strand products are 154% harder than red oak; Traditional 25% harder
- All products are radiant heat compatible
- Optimum 5.5® Moso bamboo sustainably harvested at maturity between 5-1/2 and 6 years

THIRD-PARTY CERTIFICATIONS / IN-DEPTH SPECIFICATIONS

- FloorScore® Certification – Breathe Easy! Safe for the home and workplace
- Products meet U.S. OSHA, European E0, CARB Phase 1 and Phase 2, and Japanese JIS/JAS (F☆☆☆☆) emissions standards
- ISO 9001/14001 and FSC-certified factory group - See our Material + Sustainability Report
- Lacey Act compliant
- 3-Part Specifications for architects and designers

EASE OF INSTALLATION

- Portfolio Collection, Synergy™ Wide Plank and Studio feature a patented glueless locking system
 - Wider, longer planks install faster
 - View the DIY video on teragren.com

FULL WARRANTY

- Lifetime Structural; 25-year residential finish/10-year heavy-use finish commercial warranties*

BEAUTIFUL AND COMPLETE LINES

- Ideal for any decor - from contemporary to traditional
- Affordable options to meet your budget
- Coordinating accessories (stair treads and risers, moldings, floor vents)
- Natural inherent color variation
- Environmentally friendly packaging and practices



Building a company that is environmentally, socially and economically responsible®

RELAX, it's Teragren Bamboo

The time, skill, and commitment required to bring out the richest nuances of bamboo's color and grain are evident in the enduring beauty of Teragren's products. We use Optimum 5.5[®] Moso bamboo sustainably harvested at maturity, when it is most dense, and we oversee all aspects of its manufacture, from harvest to distribution. Our Synergy™ and Portfolio Strand bamboo flooring average 154 percent harder than red oak, and our Traditional bamboo flooring averages 25 percent harder than red oak and 12 percent harder than North American maple.

Teragren flooring delivers a platform for living your life with peace of mind. All of our flooring is FloorScore®-certified, and all of our plywood panels are SCS Indoor Advantage™ Gold-certified, two of the world's most stringent environmental standards recognized as contributing to good indoor air quality.





Our superior design and Xcora™ production technologies allow us to offer a lifetime structural warranty, a 25-year residential finish warranty and a 10-year heavy-use commercial finish warranty for our flooring products.*







SYNERGY™ Wheat
4'x8' Panels - vertical grain Caramelized

Strand Bamboo Flooring

-  *PORTFOLIO COLLECTION*
-  *SYNERGY™ FLOATING FLOOR*
-  *SYNERGY™ SOLID STRIP*

Traditional Bamboo Flooring

-  *STUDIO FLOATING FLOOR*
-  *CRAFTSMAN II*
-  *SIGNATURE COLORS*
-  *SIGNATURE NATURALS*
-  *ELEMENTS*

Stair Parts + Accessories

Coordinating Strand and Traditional bamboo stair parts and flooring trim for the finishing touch.

Plywood Panels + Veneer

Perfect for fabricating eco-friendly kitchen and bath cabinetry, wall treatments, furniture and for other interior decor.

Worktops/Countertops

A beautiful and durable alternative to traditional hardwoods for any work surface including countertops, kitchen islands and table tops.

DESIGNING with Teragren

The foundation for the design of every room is a beautiful floor, and creative designing begins with the Teragren™ Color Palette Advisor. Compare paints, fabric, tiles, and texture elements that complement our Portfolio Collection of flooring. From the floor up you'll be inspired to create inviting, distinctive and comfortable living spaces.

TERAGREN™ COLOR PALETTE ADVISOR	
NATURAL TEXTURES	Brown Sugar
	Paris Black
	Rich Cognac
	Midnight Black
	Darby Brown
HAND-SCRAPED	Hewn Port
	Hewn Tawny
EMBOSSED	High Tea
	New Country
	Honey Ridge

The colors, grains and textures in Portfolio strand bamboo flooring provide you with choices for designing every project. Find favorites that complement your décor in our collection of 10 distinctive styles.

A variety of colors and textures make designing simple for home and commercial interiors. Complementary stair parts and trim are also available. Visit teragren.com for more information.

Portfolio with Xcora™ technology is 154% harder than red oak, perfect for high-traffic commercial and residential interiors.

Installation is simple and straightforward with the patented Välinge 2G fold-down, self-locking system. Just drop and lock each plank in place for a tight, clean seam that doesn't require glue, staples, or nails.

LEED® CREDITS
MR6, IEQ 4.3, IEQ 4.4

DIMENSIONS
1/2" x 5" x 72 1/2" (12mm x 126mm x 1840mm)

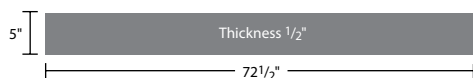

Micro-bevel on all four sides. Each box contains all 72 1/2" lengths.

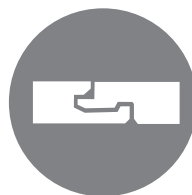

Välinge-patented 2G fold-down self-locking system



PORTFOLIO Brown Sugar

NATURAL TEXTURES

Brown Sugar

A burnt caramel backdrop for functional areas such as an office, computer room or kitchen.

Industrial, clean, neutral: Charcoal, grey tweed, steel, stone, white



NATURAL TEXTURES

Paris Black

A fascinating deep black, highlighted with streaks of brown, adds drama to high-traffic areas such as a dining room, breakfast nook or restaurant interior.

Earthy neutrals:
Espresso, cocoa brown, charcoal, light grey

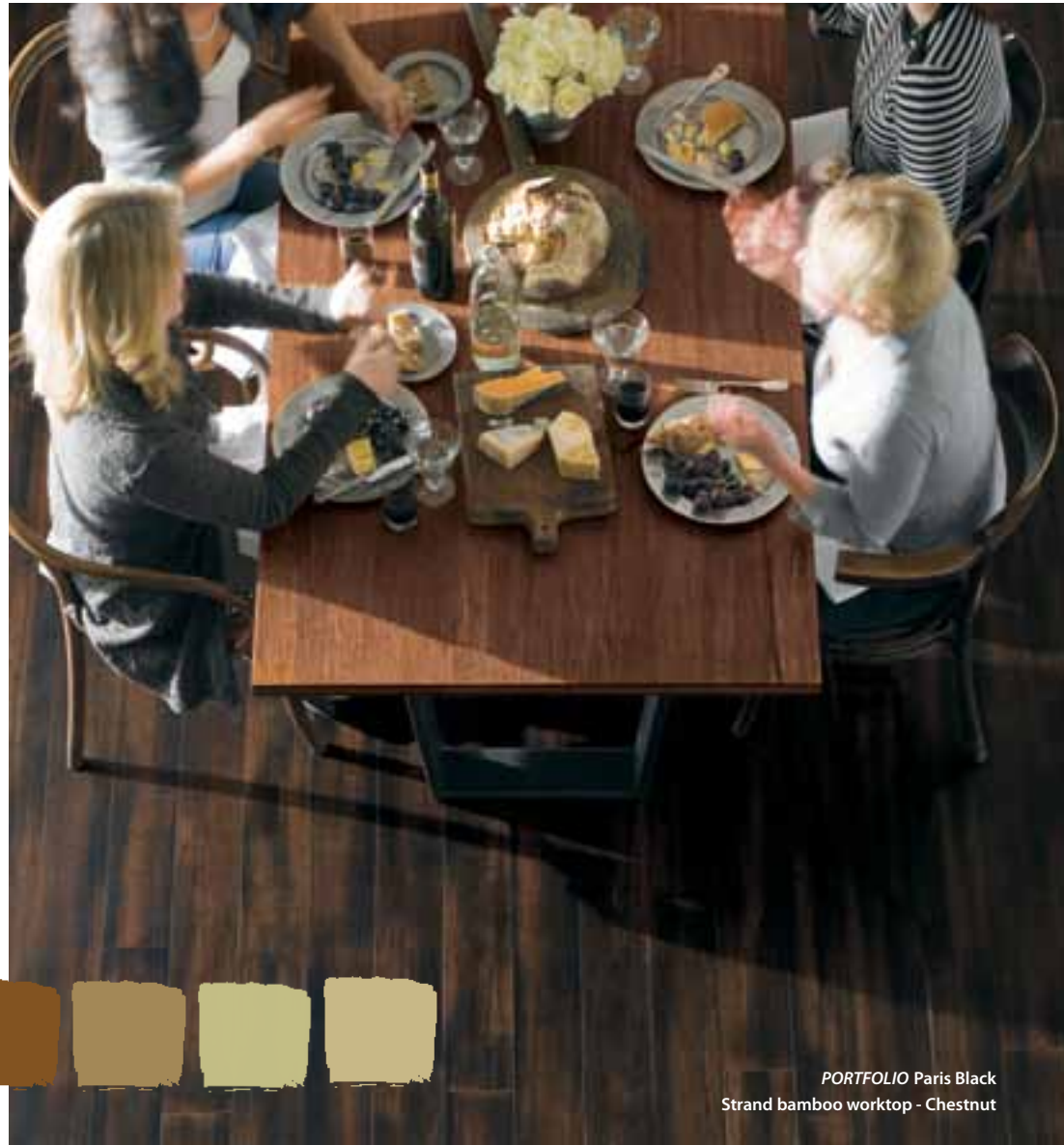

PORTFOLIO Paris Black
Strand bamboo worktop - Chestnut



Rich Cognac

A deep, sophisticated Old World brown for functional areas such as a living room, entertainment area or den.

Inviting, serene, elegant:
Wisteria blue, sapphire, periwinkle, violet, camel brown, antique wood, ivory

NATURAL TEXTURES



PORTFOLIO Rich Cognac

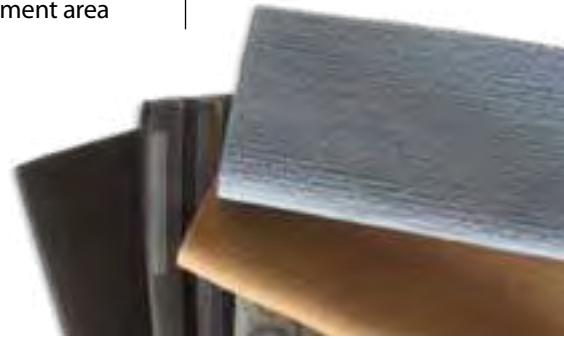



PORTFOLIO Midnight Black



NATURAL TEXTURES

Midnight Black

A deep, calming black background that could be the beginning of your library, study or a casual living room.

Bold, sophisticated: Red, crimson, red-purple, cornsilk, blonde



NATURAL TEXTURES

Darby Brown

A nearly black clove brown for warming multifunctional spaces such as a kitchen, hallway, or other high-traffic rooms.

Lively and warm: Dark orange and terra cotta, cream, dark olive green



PORTFOLIO Darby Brown



HAND SCRAPED

Hewn Port

A handscraped and glossy burgundy-enriched brown for rooms with an inviting and romantic character, such as a bedroom, front room or tea room.

Light, airy, romantic: Wine, amethyst, plum, heather, beige, cream, pearl, white, fresh green



PORTFOLIO Hewn Port



HAND SCRAPED

Hewn Tawny

A handscraped and glossy golden brown for rooms naturally full of light, such as lounges, sun porches or living areas.

Light-reflective goldens: yellow ochre, butternut squash, gold, lilac, light stone



PORTFOLIO Hewn Tawny





EMBOSSED

High Tea

A pitted and dark flecked auburn to warm well-used rooms such as a rec room or family room.

Fresh and natural: Green, leaf, olive, sienna, brown, cream, pale pink

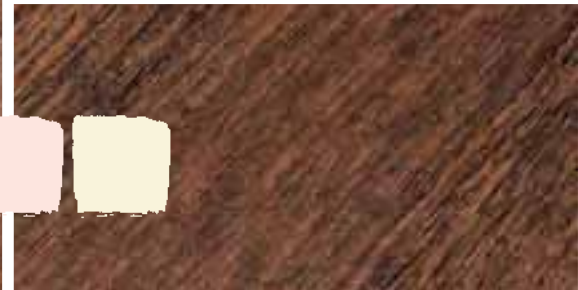

PORTFOLIO High Tea

EMBOSSED

New Country

A rustic, dark-flecked and pitted golden sand that looks great in areas such as waiting rooms and entryways.

Rich desert tones: Burnt orange, lava red, sepia, bone, stoneware, tan

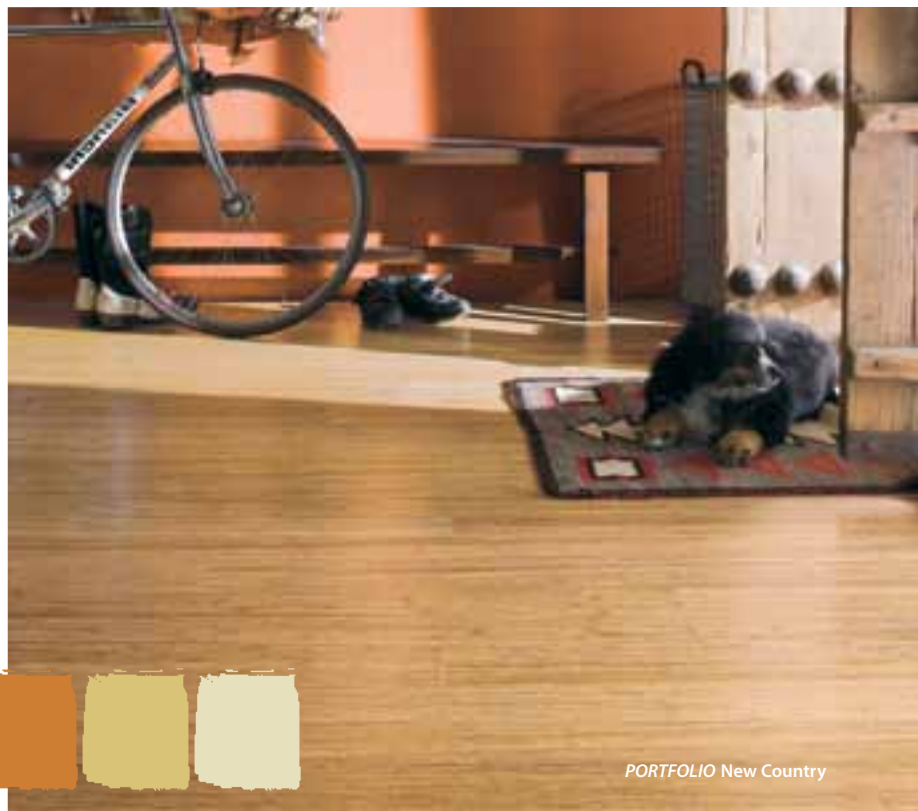

PORTFOLIO New Country



Teragren Portfolio flooring is created from rapidly renewable bamboo, which provides an environmentally responsible alternative to precious rainforest hardwoods. Discover the unlimited design potential of Portfolio bamboo flooring and create rooms that invite you to stay.

Resource note:

Bring out the beauty of your Teragren Portfolio flooring with eco-friendly materials such as low-VOC paints from Benjamin Moore, Mythic and ICI Paints, sustainable fabrics by Design Tex, tiles from Pental and bamboo worktops/countertops from Teragren.

For details on coordinating materials, visit http://teragren.com/products_flooring_portfolio_CPA.html



PORTFOLIO Honey Ridge

I had many samples of various woods and bamboo and I literally beat the daylight out of each. The Teragren bamboo was just as strong as the Brazilian hardwoods I was looking at and just as pretty. Teragren's bamboo is sustainably sourced and the finishes adhere to strict safety standards.

– <http://ecomamasguidetolivinggreen.blogspot.com/>

EMBOSSED

Honey Ridge

A pitted and flecked dark honey that complements high traffic areas such as recreational areas and children's rooms.

Primary colors: Red, gold, pencil yellow, blue, white



SYNERGY™ FLOATING FLOOR, Strand with Xcora™ technology, prefinished, wide-plank, 7-11/16" x 9/16" x 72"

SYNERGY™ floating floor with Xcora™ is 154% harder than red oak, and the wider, longer, square-edged planks lock together quickly to complement a variety of decors.

(195mm x 14mm x 1830mm)

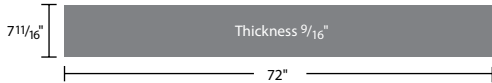

- Square edges on all four sides
- Each box contains all 72" lengths
- Välinge-patented self-locking system

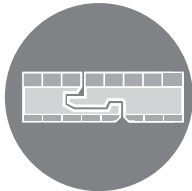

U.S. Patent No. 7,836,655
100% bamboo cross-ply engineered construction for greater stability.

SYNERGY™ SOLID STRIP 12mm

Strand with Xcora™ technology, prefinished, solid-strip, 3-3/4" x 1/2" x 24", 36", 48" and 72"

SYNERGY™ strand solid-strip flooring offers a random visual in multiple precise lengths. Exclusive Xcora™ technology makes Synergy™ perfect for high-traffic residential and commercial use - 154% harder than red oak.

- Micro-bevel on all four sides
- Tongue and groove
- Nail or glue down

(96mm x 12mm x 610mm, 915mm, 1220mm, 1830mm)

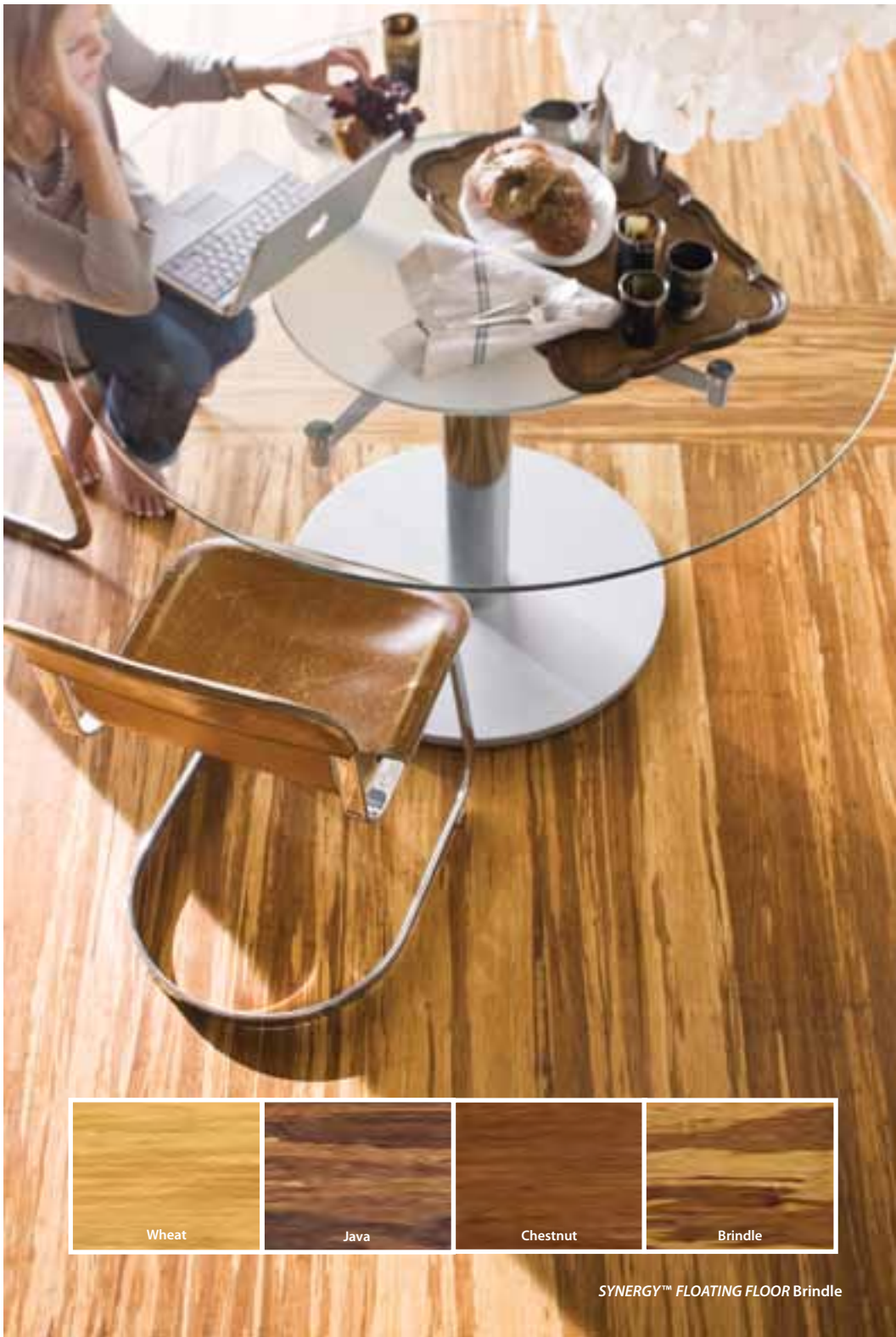
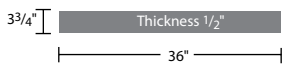

SYNERGY™ FLOATING FLOOR Brindle

SYNERGY™ SOLID STRIP 10mm Strand with Xcora™ technology, prefinished, solid strip, 3-3/4" x 3/8" x 72"

Synergy™ strand solid-strip bamboo flooring in 3/8" (10mm) and six-foot lengths is designed to provide optimal affordability for homeowners as well as builders and developers.

- Micro bevel on all four sides
- Tongue and groove
- Recommended glue down only

(96mm x 10mm x 1830mm)



STUDIO FLOATING FLOOR, Traditional, prefinished, wide-plank with self-locking system, 7-11/16" x 9/16" x 75"

Studio is ideal for high-rise condominiums or offices as well as residential installations. Square-edged wide planks offer a seamless look and the glueless, self-locking installation is fast and easy. 25% harder than red oak; 12% harder than maple.

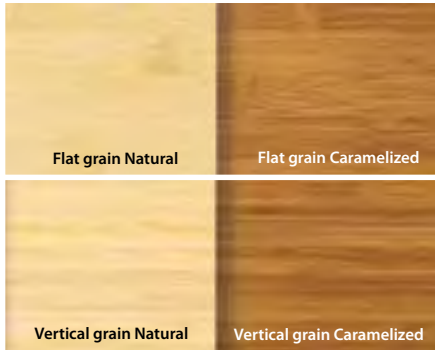

(195mm x 14mm x 1905mm)

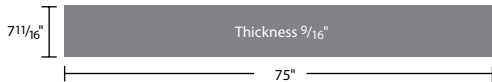

- Square edges on all four sides
- Each box contains all 75" lengths
- Välinge-patented self-locking system

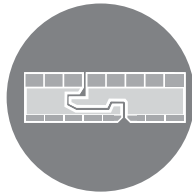

*I wish I had installed these floors years ago!
Best home improvement we have ever done.*
- L. Hammill, Hesperia, CA

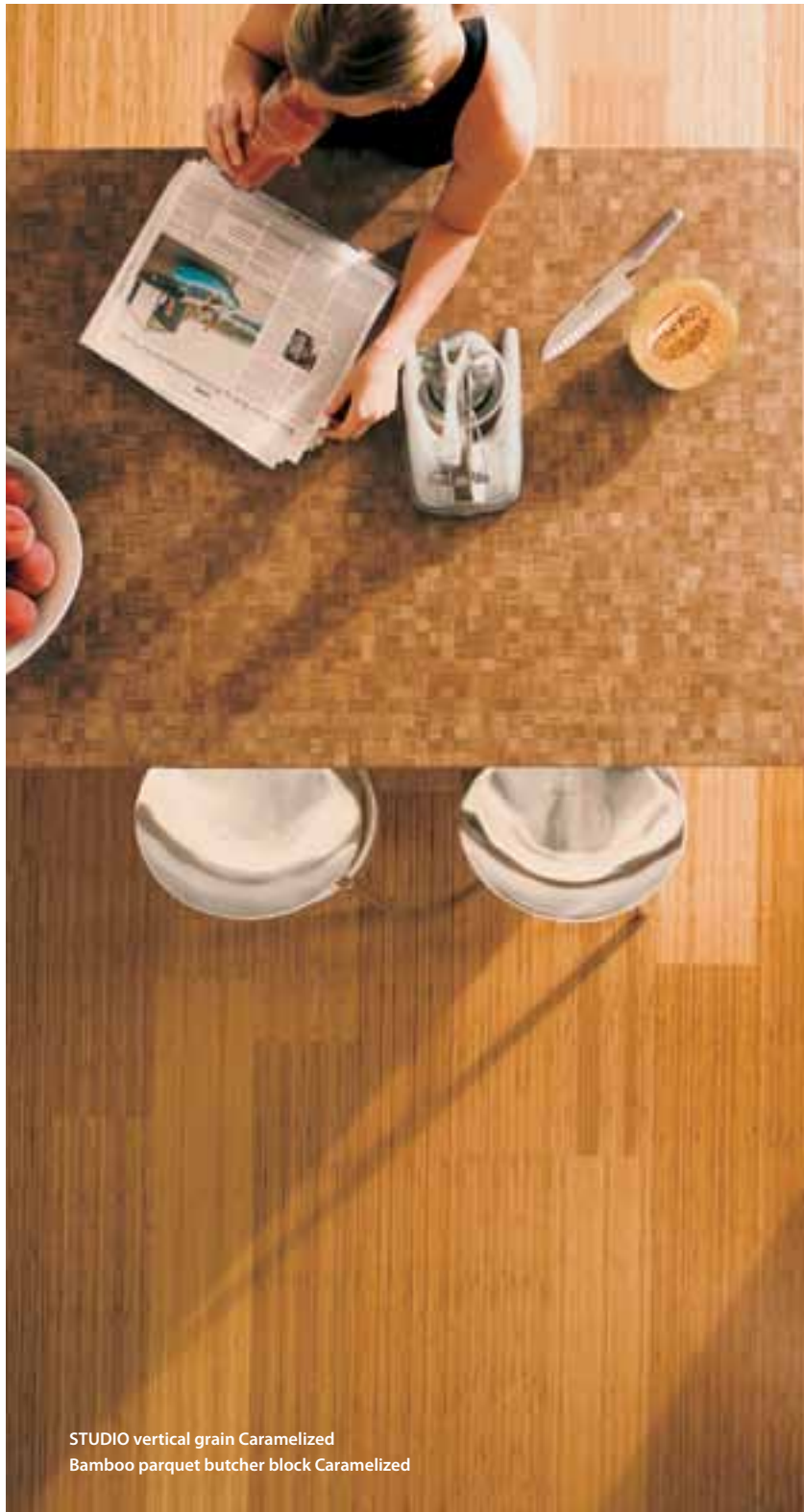

STUDIO vertical grain Caramelized
Bamboo parquet butcher block Caramelized

CREATE with Teragren

We offer beautiful, high-performance bamboo flooring options for virtually every type of installation and provide an abundance of complementary products to complete your design from cabinetry panels to table tops.

SIGNATURE COLORS, Traditional solid-strip, prefinished, 3-5/8" x 5/8" x 24", 36", 48" and 72"



Subtle grains infused with nuanced stain colors suit contemporary, traditional and eclectic styles. The semi-transparent stain enhances the natural color variations.

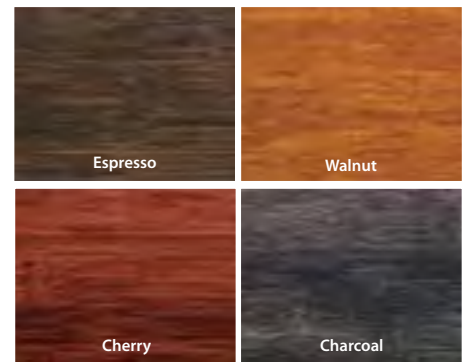

- Micro-bevel on all four sides
- Tongue and groove
- Nail, staple or glue down
- Flat grain with stain colors; vertical grain by special order

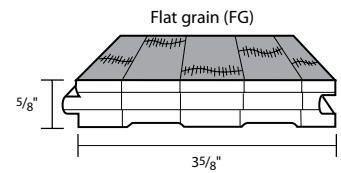
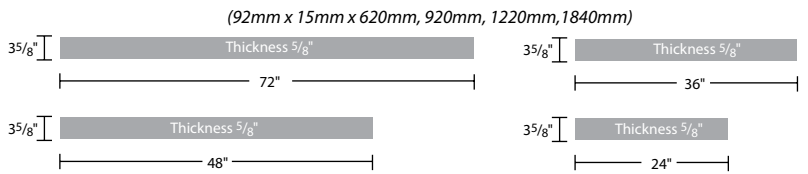

CRAFTSMAN II, Traditional, prefinished, long-plank, 5 1/2" x 5/8" x 75-1/2"

Classically scaled wide, long planks anchor grand spaces with traditional flair.

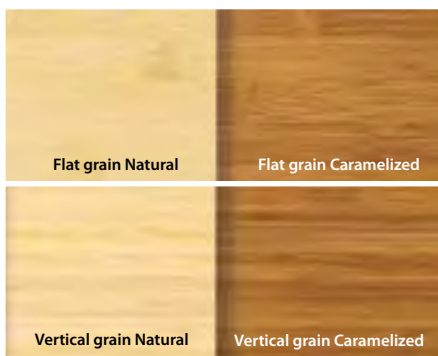

- Micro bevel on all four sides
- Tongue and groove
- Each box contains all 75-1/2" lengths
- Nail, staple, glue or float
- Also available unfinished - see teragren.com for details

(138mm x 15mm x 1920mm)

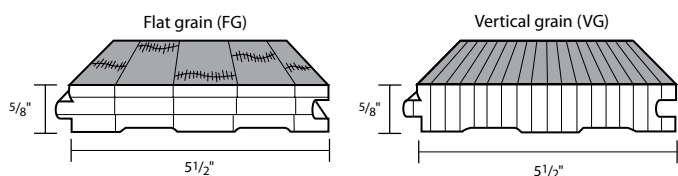

CRAFTSMAN II vertical grain Natural

The width and lengths are comparable to any traditional hardwood floor and work beautifully with any design. Signature Naturals is 25% harder than red oak - ideal for any room in the home or workplace.

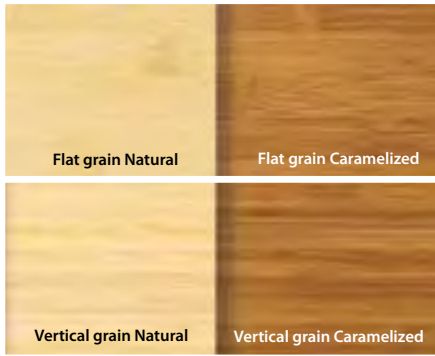

- Micro-bevel on all four sides
- Tongue and groove
- Nail, staple, or glue down
- Also available unfinished - see teragren.com for details

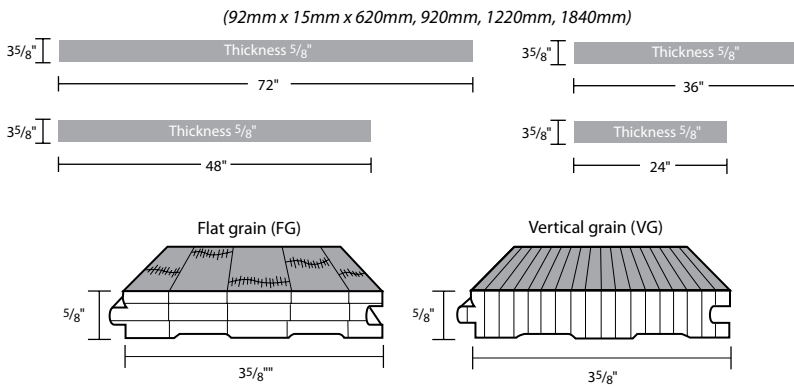

SIGNATURE NATURALS flat grain Caramelized

ELEMENTS, Solid-strip bamboo flooring in 3' lengths, 3-5/8" x 5/8" x 36"

Elements is designed to provide optimal affordability to homeowners as well as builders and developers. High color variation within and between planks.

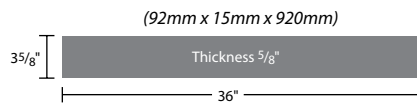

- Micro-bevel on all four sides
- Tongue and groove
- Each box contains all 36" lengths
- Nail, staple, or glue down

RELY on Teragren

The long-lasting beauty of our flooring comes from its dependable durability and ease of care. Our flooring also provides peace of mind by contributing to exceptional indoor air quality.

- Teragren flooring is protected by a 7-coat proprietary finish, including abrasion-resistant aluminum oxide and two polyurethane topcoats; this finish carries a 25-year residential/10-year heavy-use commercial warranty*
- Care is easy—simply keep it dirt and grit-free, and clean it with a recommended cleaner—see teragren.com for details
- All Teragren flooring is FloorScore®-certified and has been tested for 78 volatile organic compounds
- All Teragren flooring may be installed over radiant heat
- FSC-certified bamboo flooring available
- Teragren flooring is guaranteed by a lifetime-structural warranty



Select FSC-products available.



With a 16-year track record of providing high-quality bamboo products, Teragren is clearly the industry leader when it comes to bamboo flooring, panels and countertops.
 — Keith Rosen, Gensler Architects (NYC)

*Does not apply to Synergy™ 10mm and Elements

Stair parts + flooring trim

Complete your design with our extensive line of prefinished and site-finished accessories that coordinate with all Teragren bamboo flooring.









	Architectural Molding <ul style="list-style-type: none"> • Craftsman II: VGN, VGC, FGN, FGC • Signature Naturals: VGN, VGC, FGN, FGC • Studio: VGN, VGC, FGN, FGC • Elements: VGN, VGC, FGN, FGC 	
	Base Molding <ul style="list-style-type: none"> • Craftsman II: VGN, VGC, FGN, FGC • Signature Naturals: VGN, VGC, FGN, FGC • Signature Colors: Espresso, Charcoal, Cherry, Walnut • Studio: VGN, VGC, FGN, FGC • Synergy: Wheat, Chestnut, Java, Brindle • Elements: VGN, VGC, FGN, FGC 	
	Base Shoe <ul style="list-style-type: none"> • Craftsman II: VGN, VGC, FGN, FGC • Signature Naturals: VGN, VGC, FGN, FGC • Signature Colors: Espresso, Charcoal, Cherry, Walnut • Studio: VGN, VGC, FGN, FGC • Synergy: Wheat, Chestnut, Java, Brindle • Elements: VGN, VGC, FGN, FGC 	
	T-mold <ul style="list-style-type: none"> • Craftsman II: VGN, VGC, FGN, FGC • Signature Naturals: VGN, VGC, FGN, FGC • Signature Colors: Espresso, Charcoal, Cherry, Walnut • Studio: VGN, VGC, FGN, FGC • Synergy: Wheat, Chestnut, Java, Brindle • Elements: VGN, VGC, FGN, FGC 	
	Baby Threshold <ul style="list-style-type: none"> • Craftsman II: VGN, VGC, FGN, FGC • Signature Naturals: VGN, VGC, FGN, FGC • Signature Colors: Espresso, Charcoal, Cherry, Walnut • Studio: VGN, VGC, FGN, FGC • Synergy: Wheat, Chestnut, Java, Brindle • Elements: VGN, VGC, FGN, FGC 	
	Floating Floor Reducer <ul style="list-style-type: none"> • Craftsman II: VGN, VGC, FGN, FGC • Studio: VGN, VGC, FGN, FGC • Synergy: Wheat, Chestnut, Java, Brindle • Elements: VGN, VGC, FGN, FGC 	
	Clamshell Reducer <ul style="list-style-type: none"> • Craftsman II: VGN, VGC, FGN, FGC • Signature Naturals: VGN, VGC, FGN, FGC • Signature Colors: Espresso, Charcoal, Cherry, Walnut • Studio: VGN, VGC, FGN, FGC • Synergy: Wheat, Chestnut, Java, Brindle • Elements: VGN, VGC, FGN, FGC 	
	Floor Vents Flush-mount or self-rimming available in standard and custom sizes <ul style="list-style-type: none"> • Craftsman II: VGN, VGC, FGN, FGC • Signature Naturals: VGN, VGC, FGN, FGC • Signature Colors: Espresso, Charcoal, Cherry, Walnut • Studio: VGN, VGC, FGN, FGC • Synergy: Wheat, Chestnut, Java or Brindle • Elements: VGN, VGC, FGN, FGC 	

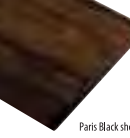

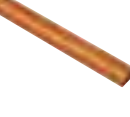
Teragren Flooring, Stair Treads + Risers
vertical grain Natural

PORTFOLIO Collection | Flooring Trim

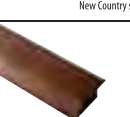
Visit teragren.com for stair parts and accessory dimensions.

	
Paris Black shown	
	
Honey Ridge shown	
	
New Country shown	
	
Rich Cognac shown	

Coordinating Stair Parts

Stair Riser in 48" lengths



Stair Nosing in 72" lengths



Stair Tread in 48" lengths



Floor Vents

Self-rimming only



Worktops/Countertops

To help you complete your design, Teragren provides coordinating bamboo worktops to industry-leading and environmental standards.

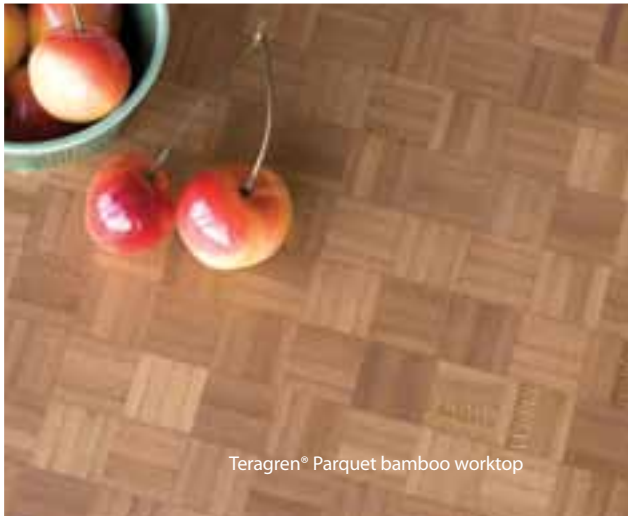

Teragren® Bamboo Parquet Butcher Block

Natural or Caramelized

- 30" x 96" x 1½" or 36" x 72" x 1½"
- Food-safe —ideal for cutting surfaces and food prep areas
- Durable, end-grain parquet – harder than maple
- Prefinished with a food-safe mineral oil/beeswax finish
- Available unfinished

30" x 96" x 1½" (762mm x 2440mm x 38mm)

36" x 72" x 1½" (915mm x 1830mm x 38mm)



Teragren® Traditional Bamboo Worktop

Vertical Grain Caramelized face with Chestnut strand bamboo core or
Vertical Grain Natural face with Wheat strand bamboo core

- 30" x 96" x 1½" or 36" x 72" x 1½"
- Prefinished with a food-safe mineral oil/beeswax finish
- Available unfinished

30" x 96" x 1½" (762mm x 2440mm x 38mm)

36" x 72" x 1½" (915mm x 1830mm x 38mm)



Teragren® Strand Bamboo Worktop

Chestnut strand bamboo face with Vertical Grain Caramelized core or
Wheat strand bamboo face with Vertical Grain Caramelized core

- 36" x 72" x 1½"
- Ideal for kitchen counters, islands, table tops or other furniture applications
- 154% harder than red oak
- Unfinished
- Available with mineral oil/beeswax finish by special order

36" x 72" x 1½" (915mm x 1830mm x 38mm)



Environmentally Smart

Since 1994, Teragren® has upheld their mission to help reduce dependence on dwindling timber resources by manufacturing competitively priced bamboo flooring, panels/veneer and worktops/countertops, made from sustainably harvested Optimum 5.5® Moso bamboo. Read on to learn why Teragren bamboo is an environmentally responsible and sensible choice for you and the planet.



Sustainably Harvested

- Teragren bamboo is produced from rapidly renewable Optimum 5.5® Moso bamboo, which grows to maturity in just 5 to 6 years; hardwoods take 80+ years.
- As a manufacturer we control our production process from harvest to distribution. Our factories are ISO 9001: 2000 and 14001-certified.
- We have 11 manufacturing and quality assurance checkpoints and use advanced, state-of-the-art equipment to fortify durability.
- FSC-certified products are available by special order and are delivered through a FSC Chain-of-Custody-certified distribution channel.



Excels in Environmental Standards

- All of our products are independently tested in the U.S.
- Our durable proprietary 7-coat factory finish is water-based, solvent-free and carries a 25-year residential/10-year heavy-use commercial finish warranty.*
- Our proprietary manufacturing adhesive emits less formaldehyde than allowed by U.S. OSHA, European E0, CARB Phase 1 and CARB Phase 2, and Japanese JIS/JAS (F☆☆☆☆) emissions standards. Select products are available manufactured with a formaldehyde-free adhesive.
- All Teragren flooring is FloorScore®-certified - breathe easy! Tested for 78 VOCs- safe for the home and workplace.

Sequesters More Carbon

- Bamboo absorbs more carbon than a comparable hardwood forest (and also releases 35% more oxygen).
- Teragren's products lock up carbon, reducing CO2 levels that lead to climate change.
- No more than 25% of the CO2 sequestered in Teragren products is emitted during their transport to market. The remaining 75% of sequestered carbon is permanently locked up within the products.

Contributes to LEED® credits

- MR 6: Rapidly Renewable Materials - all Teragren bamboo products qualify.
- MR 7: Certified Wood - FSC-certified bamboo products available - just ask!
- IEQ 4.3: Low-Emitting Materials - Flooring Systems - all Teragren bamboo flooring products qualify.
- IEQ 4.4: Low-Emitting Materials - Composite Wood and Agrifiber Products - Teragren products made with non-urea manufacturing adhesives qualify.



 Like us
www.Facebook.com/Teragren

 Follow us
www.Twitter.com/Teragren

 Watch us
www.YouTube.com/TeragrenBamboo

teragren.com



FINE BAMBOO FLOORING, PANELS & VENEER

12715 Miller Road NE
Suite 301
Bainbridge Island, WA
98110

800.929.6333 toll-free
206.842.9477 tel
206.842.9456 fax
info@teragren.com



Printed on FSC-certified paper
with vegetable-based inks