

# Johnsonite

## Floor Finishing Accessories

Adaptors

Reducers

Transitions

Corner Guards

Wall Protectors

Edge Guards

Mouldings

Leveler System

To have an integrated system you have to have all the pieces of the puzzle. You must be able to complete the entire space. Meet Johnsonite Finishing Accessories. They hold everything together, leaving nothing to chance. Every detail considered, every element coordinated, they're the final components that let you finish off space design functionally, without compromising aesthetics.

Created for a myriad of everyday needs, Johnsonite Finishing Accessories are also designed to meet, or exceed, the recommendations of the Americans with Disabilities Act (ADA). Special engineering means they can help minimize the potential for slip and fall accidents, avoiding the costly drain on resources that often follows.

Accessories help demonstrate Johnsonite innovation at its best. For instance, Wheeled Transitional Mouldings that create a gradual transition between floors of varying heights, helping both wheeled and ambulatory traffic move about more easily and safely. And every other accessory needed to complete your space without compromising.

**TRACK BASE**

<p><b>CDB-00-A</b> Rigid Vinyl</p>		<p>Pinless for glue-down installation. Neutral color only.</p>
<p><b>MT-00-A</b> Aluminum</p>		<p>Pinless for glue-down installation.</p>
<p><b>MT-00-B</b> Aluminum</p>		<p>Pin type for stretch-in installation.</p>
<p><b>MTC-00-A</b> Aluminum</p>		<p>Pinless for glue-down installation. Minimum contour radius 6".</p>
<p><b>MTC-00-B</b> Aluminum</p>		<p>Pin type for stretch-in installation. Minimum contour radius 6".</p>

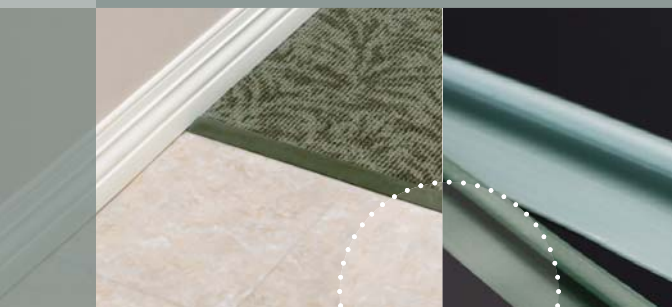

## EXPANSION JOINT SEALS

EJS-XX

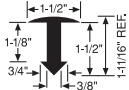

1-1/2" wide expansion joint strip for resilient materials.

❖ Patented

EJS-XX-B

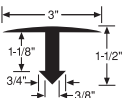

3" wide expansion joint strip for resilient materials.

❖ Patented

❖ U.S. Patent No. 5,888,017

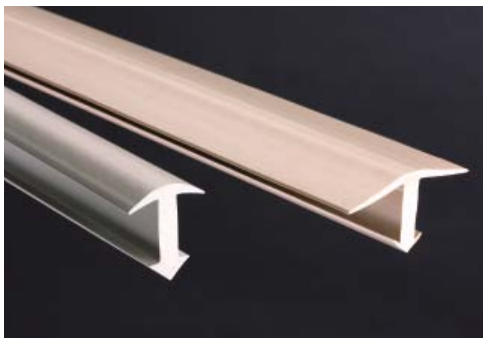

## T MOULDINGS

CE-XX-A

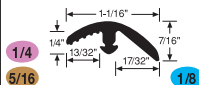

1/4" or 5/16" to 1/8" material.  
1/4" leg.

CE-XX-C

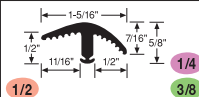

1/2" to 1/4" or 3/8" material.  
1/2" leg.

CD-XX

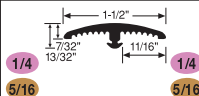

1/4" or 5/16" to 1/4" or 5/16" material. 1/4" leg.

CD-XX-A

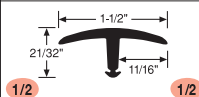

1/2" to 1/2" material.  
1/2" leg.

CD-XX-B

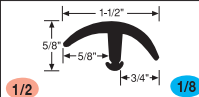

1/2" to 1/8" material.  
1/2" leg.

CD-XX-C

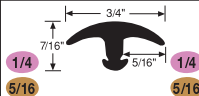

1/4" or 5/16" to 1/4" or 5/16" material. 1/4" leg.

CD-XX-W

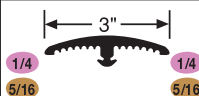

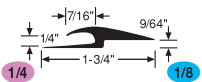
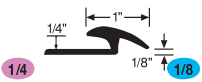
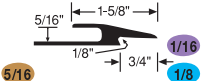
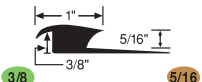
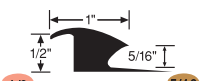

1/4" or 5/16" to 1/4" or 5/16" material. 1/4" leg.

## ADAPTORS



CTA-XX-A		1/4" to 1/8" material.
CTA-XX-C		1/4" to 1/8" material.
CTA-XX-D		5/16" to 1/16" or 1/8" material.
CCA-XX		3/8" to 5/16" material.
CWA-XX		1/2" to 5/16" material.

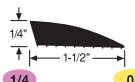
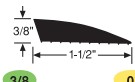
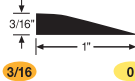
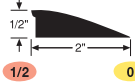
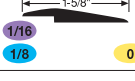
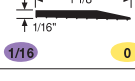
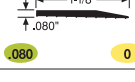
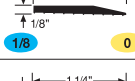

## REDUCERS

CRS-XX-A		1/4" material to floor.
CRS-XX-B		3/8" material to floor.
CRS-XX-C 50' roll		3/16" material to floor.
CRS-XX-D		1/2" material to floor.
SSR-XX-B 35' roll		1/16" or 1/8" material to floor.
RRS-XX-A 3' pieces		1/16" material to floor.
RRS-XX-B 3' pieces		.080" material to floor.
RRS-XX-C 3' pieces		1/8" material to floor.
RRS-XX-D 25' roll		1/8" material to floor.

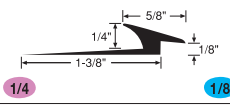
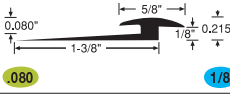
## SLIM LINE TRANSITIONS

SLT-XX-A		1/4" to 1/8" material.
	1/4" (pink circle) 1/8" (blue circle)	
SLT-XX-B		.080" to 1/8" material.
	.080 (green circle) 1/8" (blue circle)	
SLT-XX-C		.080" to 1/4" material.
	.080 (green circle) 1/4" (pink circle)	

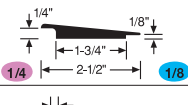
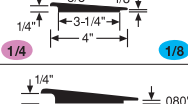
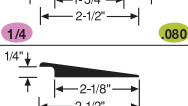
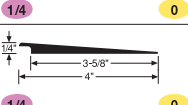
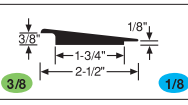
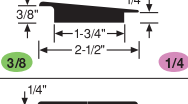
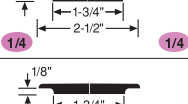
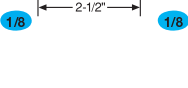

## WHEELED TRAFFIC TRANSITIONS

CTA-XX-H		1/4" to 1/8" material.
✦ Patented	1/4" (pink circle) 1/8" (blue circle)	
CTA-XX-HL		1/4" to 1/8" material.
✦ Patented	1/4" (pink circle) 1/8" (blue circle)	
CTA-XX-HT		1/4" to .080" or 2 mm material.
✦ Patented	1/4" (pink circle) .080 (green circle)	
CTA-XX-J		1/4" material to floor.
	1/4" (pink circle) 0 (yellow circle)	
CTA-XX-JL		1/4" material to floor.
	1/4" (pink circle) 0 (yellow circle)	
CTA-XX-K		3/8" to 1/8" material.
✦ Patented	3/8" (green circle) 1/8" (blue circle)	
CTA-XX-L		3/8" to 1/4" material.
✦ Patented	3/8" (green circle) 1/4" (pink circle)	
CTA-XX-M		1/4" to 1/4" material.
	1/4" (pink circle) 1/4" (pink circle)	
CTA-XX-N		1/8" to 1/8" material.
	1/8" (blue circle) 1/8" (blue circle)	

## WHEELED TRAFFIC TRANSITIONS

CTA-XX-P		3/8" material to floor.
CTA-XX-PL		3/8" material to floor.
CTA-XX-Q		1/2" material to floor.
CTA-XX-X		.080" to 1/8" material.
CTA-XX-Y		.080" to .080" material.
CTA-XX-Z		.080" to 3/8" material.

♣ U.S. Patent No. 5,581,967

For available colors reference color palette A on last page.  
+14 Tropical Storm, 15 Cabernet, 129 Silk and 132 Espresso.

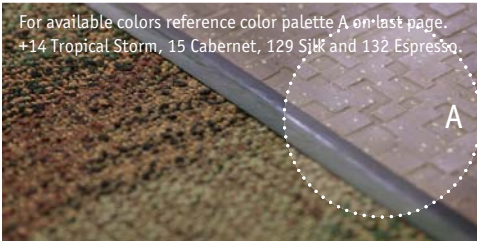

## FLEXIBLE VINYL CORNER GUARDS

Johnsonite's corner guards will not only complement the interior space, but also work to protect your finished design.

- Will not shrink, crack or chip
- Three return sizes: 2-3/8"; 1-1/2" and 3/4"
- Available in 32 ColorMatch® colors and 5 additional colors

## FLEXIBLE VINYL CORNER GUARDS

<b>VBG-XX-B-48</b> ■ <b>VBG-XX-B-96</b> ■ 4' or 8' pieces		Corner guard. 3/4" returns. 1/8" thick. Tapered ends.
<b>VBG-XX-A-48</b> ■ <b>VBG-XX-A-96</b> ■ 4' or 8' pieces		Corner guard. 1-1/2" returns. 1/8" thick. Tapered ends.
<b>VBG-XX-48</b> ■ <b>VBG-XX-96</b> ■ 4' or 8' pieces		Corner guard. 2-3/8" returns. 1/8" thick. Tapered ends.
<b>VBG-XX-C</b> ◆ 8' pieces		Millwork profile corner guard. 1/4" thick.

■ Also available in 68 White Sand and 79 Bone White.

◆ Available in Selects Color Palette. See Johnsonite Story or Color Guide for details.

**FLEXIBLE  
VINYL  
CORNER  
GUARDS**

**CLEAR LEXAN  
CORNER  
GUARDS AND  
WALL  
PROTECTORS**

**CLEAR LEXAN® CORNER GUARDS  
AND WALL PROTECTORS**

Clear Lexan® Corner Guards and Wall Protectors allow the wall surface to show through while protecting wall coverings and finishes.

**CLEAR LEXAN CORNER GUARDS  
AND WALL PROTECTORS**

\*Available in  
3/4" and  
1-1/8" returns.  
▲

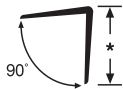

4' and 8' lengths.  
Available in self-  
stick or with  
self-tapping  
nail screws.

\*Available in  
1-1/8", 1-1/2",  
2" and 2-1/2"  
returns.  
▲

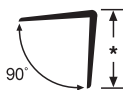

4' and 8' lengths.  
Pre-drilled  
mounting holes  
and chrome  
screws.

\*Available in  
3" and 4"  
widths.  
▲



Wall protector.  
8' lengths.  
Fasten with  
screws provided.

▲ Available in clear material only.

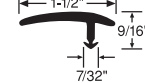
**TRANSITIONS FOR LAMINATE  
FLOORING**
**CD-XX-B1**

Flexible transition  
for laminate  
flooring to same  
height materials.

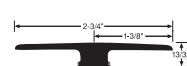
**DPT-XX-A**

Flexible transition  
for laminate to  
laminate flooring  
or laminate to same  
height materials.

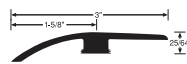
**DPT-XX-B**

Flexible transition  
for laminate to  
carpet or resilient  
materials.

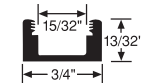
**DPT-XX-C**

Flexible track base  
for DPT-XX-A  
and DPT-XX-B  
profiles.

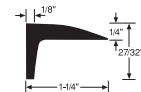
**DPT-XX-D**

Flexible edge to  
finish exposed  
laminate surfaces.

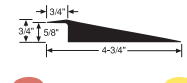
**DPT-XX-FR**  
4' pieces

Flexible reducer  
for transitioning  
from 5/8" laminate  
to floor.

5/8
0



### LAMINATE TRANSITION COLORS



**169 Tamarind**    **170 Brownie**    **171 Golden**    **172 Acorn**



**173 Auburn**    **174 Ginger**    **175 Caramel**

Transitions for laminate flooring are available in the 7 colors shown above plus additional colors shown below, which can be found on the color palette on the last page.

- |                     |                     |                      |
|---------------------|---------------------|----------------------|
| <b>29 Moon Rock</b> | <b>34 Almond</b>    | <b>45 Sandalwood</b> |
| <b>49 Beige</b>     | <b>80 Fawn</b>      | <b>129 Silk</b>      |
| <b>130 Sisal</b>    | <b>132 Espresso</b> | <b>167 Fudge</b>     |

### COVE FILLER STRIPS

<b>CFS-00</b>		1-3/4" radius. Neutral only.
<b>CFS-00-A</b>		1-1/4" radius. Neutral only.
<b>CFS-00-M</b> 5' pieces		1" radius. Neutral only.



### COVE CAPS

<b>SCC-XX-A</b>		For 1/8" materials.
<b>SCC-XX-B</b>		For 1/8" materials.
<b>CCC-XX-A</b>		For 1/4" or 5/16" materials.
<b>CCC-XX-B</b>		9/32" inside dimension.
<b>CCC-XX-C</b>		For 1/4" materials.
<b>CCC-XX-D</b>		For 3/16" materials.
<b>RCC-XX</b> 250' roll		For 1/4" or 5/16" materials.
<b>SCC-XX-D</b> with self-stick tape		For .080 materials.





**MATTE**



**CT-40**  
Black



**CT-218**  
Bluebell



**CT-217**  
Evergreen



**CT-213**  
Slate

**SPECKSTONE®**



**CT-216**  
Bluestone



**CT-214**  
Greystone



**CT-219**  
Drystone



**CT-215**  
Tundra

**METALLIC**



**CT-205**  
Burnt Almond



**CT-207**  
Doubloon



**CT-209**  
Tin



**CT-210**  
Silver



**CT-212**  
Zinc

**THRESHOLDS** U.S. Patent No. 6,553,616

**VT-XX-M2**  
3' pieces

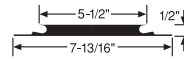

5-1/2" carpet threshold. For stretch-in and glue-down carpet and ceramic.

**VT-XX-M6**  
3' pieces



1-3/4" carpet threshold. For stretch-in and glue-down carpet and ceramic.

**FEATURE STRIPS**

**FS-XX-DW1**  
50' roll



1/4" wide feature strip for 1/8" material.

**FS-XX-DW2**  
50' roll



1/2" wide feature strip for 1/8" material.

**FS-XX-DW3**  
50' roll



1" wide feature strip for 1/8" material.

**CONTOUR EDGES**

**CT-XX**  
8.1' pieces

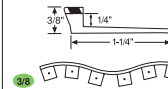

3/8" to 1/4" material for curved installations up to 20" radius.

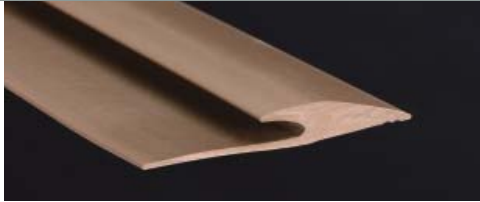

## EDGE GUARDS

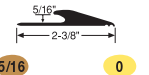
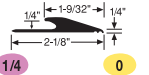
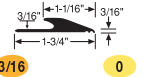
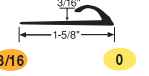
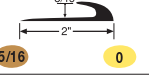
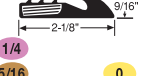
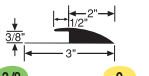
<b>EG-XX-G</b> 	5/16" material to floor.
<b>EG-XX-H</b> 	1/4" material to floor.
<b>EG-XX-J</b> 	3/16" material to floor.
<b>EG-XX-K</b> 	3/16" material to floor.
<b>EG-XX-L</b> 	5/16" material to floor.
<b>EG-XX-M</b> 	1/4" or 5/16" carpet over tackless to floor.
<b>EG-XX-W</b> 	3/8" material to floor.

## SAFETY STRIDE TRANSITIONS

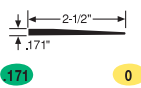
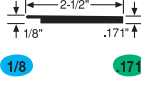
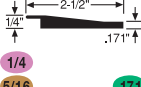
<b>SST-XX-A</b> 	Safety Stride to floor. Tapered reducer.
<b>SST-XX-B</b> 	Safety Stride to 1/8" material.
<b>SST-XX-C</b> 	Safety Stride to 1/4" or 5/16" material.

## TUB MOULDINGS

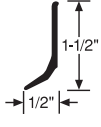
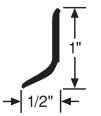
<b>TM-50*</b> 5' pieces (Self-Stick)		Luster finish cove for bathtub, counter and shelves. 1-1/2" height. White only.
<b>TM-50-A*</b> 5' pieces (Self-Stick)		Luster finish cove for bathtub, counter and shelves. 1" height. White only.

\* Available in 50 White only.



# color palette A

For actual color representation please refer to the Johnsonite Color Guide or Johnsonite Story.

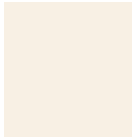

01 Snow White W ■

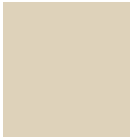

34 Almond W ■

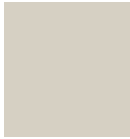

22 Pearl CB ■

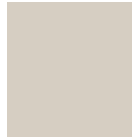

24 Grey Haze WG



31 Zephyr CB

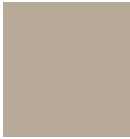

49 Beige WB ■

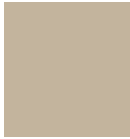

09 Clay WB ■



42 Sable WB



45 Sandalwood WB ■

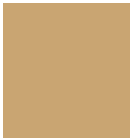

130 Sisal ■



33 Adobe Peach



76 Cinnamon ■

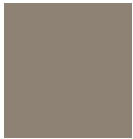

80 Fawn CB ■

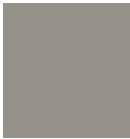

32 Pebble WG



55 Silver Grey WG

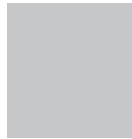

21 Platinum CG



38 Pewter CG



28 Medium Grey CG



71 Storm Cloud CG



29 Moon Rock WG

**ColorMatch** is a designer palette of 32 leading colors that match Johnsonite's Rubber and Vinyl Specialty Flooring Products and Finishing Accessories.



48 Grey WG



20 Charcoal WG ■



18 Navy Blue



41 Sea Breeze



59 Heather Green



86 Hunter Green



58 Windsor Blue



92 Blue Lagoon

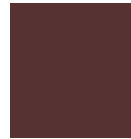

85 Burgundy



63 Burnt Umber B ■



47 Brown ■



40 Black B ■

## ADDITIONAL COLORS



14 Tropical Storm

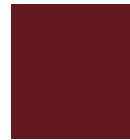

15 Cabernet



129 Silk WB



132 Espresso

■ = Indicates colors that are part of the Selects Color Palette

For your convenience, we've identified Color Foundations™ neutrals in the following way:

WB (warm beige)

WG (warm grey)

B (black)

CB (cool beige)

CG (cool grey)

W (white)

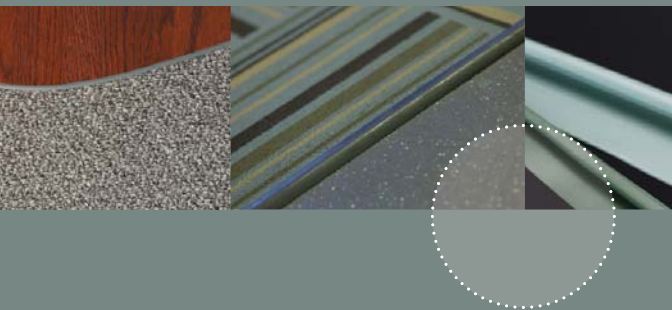

# Johnsonite®

USA: (800) 899-8916 Fax (440) 543-8920  
Canada: (800) 661-2162 Fax (519) 747-9155  
[www.johnsonite.com](http://www.johnsonite.com)

©2007 Johnsonite, Inc. A Tarkett Company.  
Printed in the U.S.A. 95100 - 656 05/07