



# **Drains & Scuppers**

*Technical Product Information*

**Roof Drains and Scuppers for new construction**



**PVC Roof Drain  
with Plus Pack**



**Parapet/Scupper Drain**



**Cast Roof Drain**



**NOTES:** \*Included in standard roof drain.  
\*\*(PlusPack) Includes standard roof drain and Plus Pack.

### **DOMESTRAINER\***

Portals Plus Dome Strainer is molded polyethylene that is ultraviolet stabilized for longevity. The Dome Strainer bolts securely to clamping collar (Dome Strainer also available in epoxy coated cast aluminum).

### **CLAMPING COLLAR/GRAVEL GUARD\***

Portals Plus cast aluminum epoxy coated Gravel Guard and Clamping Collar is grooved for positive drainage and insures a maximum hold on roofing materials.

### **DRAIN BOWL\***

Portals Plus injection molded PVC Drain Bowl is ultraviolet stabilized for long life and is available in 3", 4" and 6" sizes (also available in cast iron or cast aluminum).

### **UNDERDECK CLAMP\*\***

Portals Plus cast aluminum underdeck clamp holds the drain bowl securely to the deck

### **EXTENSION\*\***

Portals Plus Extension is a 6" length of schedule 40 pipe that extends the drain bowl down below the deck, to accommodate the expansion coupling.

### **EXPANSION COUPLING\*\***

Portals Plus flexible Expansion Coupling allows for expansion and contraction that enables the installer to connect the drain to various types of piping (two stainless steel clamps included).

**TYPICAL BUR  
INSTALLATION**

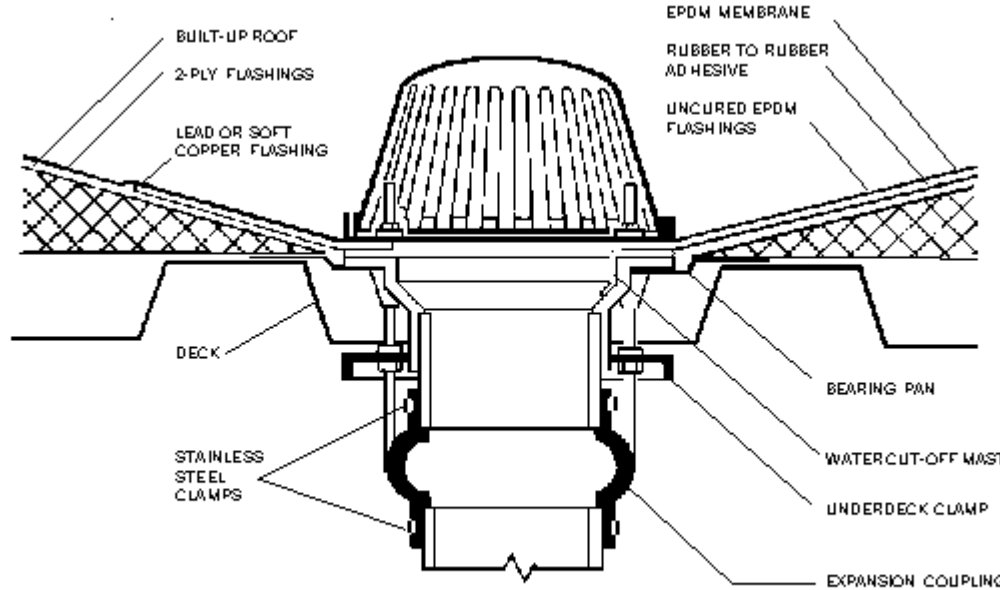

(AS DETAILED IN NRCA MANUAL)

How many Roof Drains do I need? See the [Roof Drain Calculator](#).

[Installation Instructions](#).

Call Customer Service For Price

	PVC ROOF DRAINS			LIST PRICE PER UNIT
	WHITE PVC PART NUMBER	WILL FIT I.D.	DESCRIPTION	
	<a href="#">61001</a>	3"	PVC ROOF DRAIN - w/ PLASTIC DOME	
	<a href="#">61041</a>		PVC ROOF DRAIN - w/ ALUMINUM DOME	
	<a href="#">61011</a>	4"	PVC ROOF DRAIN - w/ PLASTIC DOME	
	<a href="#">61051</a>		PVC ROOF DRAIN - w/ ALUMINUM DOME	
	<a href="#">61031</a>	6"	PVC ROOF DRAIN - w/ PLASTIC DOME	
	<a href="#">61071</a>		PVC ROOF DRAIN - w/ ALUMINUM DOME	

	PVC ROOF DRAIN PLUS PACKS			LIST PRICE
	WHITE PVC	WILL FIT	DESCRIPTION	

PART NUMBER	I.D.		PER UNIT
<a href="#">61101</a>	<b>3"</b>	PVC PLUS PACK - w/ PLASTIC DOME	
<a href="#">61141</a>		PVC PLUS PACK - w/ ALUMINUM DOME	
<a href="#">61111</a>	<b>4"</b>	PVC PLUS PACK - w/ PLASTIC DOME	
<a href="#">61151</a>		PVC PLUS PACK - w/ ALUMINUM DOME	
<a href="#">61131</a>	<b>6"</b>	PVC PLUS PACK - w/ PLASTIC DOME	
<a href="#">61171</a>		PVC PLUS PACK - w/ ALUMINUM DOME	

	<b>CAST IRON ROOF DRAINS</b>			LIST PRICE PER UNIT
	NEW UPC PART NUMBER	WILL FIT I.D.	DESCRIPTION	
	<a href="#">62501</a>	<b>3"</b>	CAST DRAIN - w/ PLASTIC DOME	
	<a href="#">62541</a>		CAST DRAIN - w/ ALUMINUM DOME	
	<a href="#">62511</a>	<b>4"</b>	CAST DRAIN - w/ PLASTIC DOME	
	<a href="#">62551</a>		CAST DRAIN - w/ ALUMINUM DOME	
	<a href="#">62531</a>	<b>6"</b>	CAST DRAIN - w/ PLASTIC DOME	
	<a href="#">62571</a>		CAST DRAIN - w/ ALUMINUM DOME	

	<b>CAST IRON PLUS PACK ROOF DRAINS</b>			LIST PRICE PER UNIT
	NEW UPC PART NUMBER	WILL FIT I.D.	DESCRIPTION	
	<a href="#">62601</a>	<b>3"</b>	CAST PLUS PACK - w/ PLASTIC DOME	
	<a href="#">62641</a>		CAST PLUS PACK - w/ ALUMINUM DOME	
	<a href="#">62611</a>	<b>4"</b>	CAST PLUS PACK - w/ PLASTIC DOME	
	<a href="#">62651</a>		CAST PLUS PACK - w/ ALUMINUM DOME	
	<a href="#">62631</a>	<b>6"</b>	CAST PLUS PACK - w/ PLASTIC DOME	
	<a href="#">62671</a>		CAST PLUS PACK - w/ ALUMINUM DOME	

	<b>CAST ALUMINUM ROOF DRAINS</b>			LIST PRICE PER UNIT
	NEW UPC PART NUMBER	WILL FIT I.D.	DESCRIPTION	
	<a href="#">62001</a>	<b>3"</b>	CAST DRAIN - w/ PLASTIC DOME	
	<a href="#">62041</a>		CAST DRAIN - w/ ALUMINUM DOME	

	<a href="#">62011</a> <a href="#">62051</a>	4"	CAST DRAIN - w/ PLASTIC DOME CAST DRAIN - w/ ALUMINUM DOME	
	<a href="#">62031</a> <a href="#">62071</a>	6"	CAST DRAIN - w/ PLASTIC DOME CAST DRAIN - w/ ALUMINUM DOME	

	<b>CAST ALUMINUM PLUS PACK ROOF DRAINS</b>			
	NEW UPC PART NUMBER	WILL FIT I.D.	DESCRIPTION	LIST PRICE PER UNIT
	<a href="#">62101</a> <a href="#">62141</a>	3"	CAST PLUS PACK - w/ PLASTIC DOME CAST PLUS PACK - w/ ALUMINUM DOME	
	<a href="#">62111</a> <a href="#">62151</a>	4"	CAST PLUS PACK - w/ PLASTIC DOME CAST PLUS PACK - w/ ALUMINUM DOME	
	<a href="#">62131</a> <a href="#">62171</a>	6"	CAST PLUS PACK - w/ PLASTIC DOME CAST PLUS PACK - w/ ALUMINUM DOME	

	<b>ABS ROOF DRAINS (BLACK BODY)</b>			
	NEW UPC PART NUMBER	WILL FIT I.D.	DESCRIPTION	LIST PRICE PER UNIT
	<a href="#">61331</a> <a href="#">61431</a>	3"	ABS ROOF DRAIN - w/ PLASTIC DOME ABS ROOF DRAIN - w/ ALUMINUM DOME	
	<a href="#">61341</a> <a href="#">61441</a>	4"	ABS ROOF DRAIN - w/ PLASTIC DOME ABS ROOF DRAIN - w/ ALUMINUM DOME	
	<a href="#">61361</a> <a href="#">61461</a>	6"	ABS ROOF DRAIN - w/ PLASTIC DOME ABS ROOF DRAIN - w/ ALUMINUM DOME	

	<b>ABS ROOF DRAINS PLUS PACK (BLACK BODY)</b>			
	NEW UPC PART NUMBER	WILL FIT I.D.	DESCRIPTION	LIST PRICE PER UNIT
	<a href="#">61531</a> <a href="#">61631</a>	3"	ABS PLUS PACK - w/ PLASTIC DOME ABS PLUS PACK - w/ ALUMINUM DOME	
	<a href="#">61541</a> <a href="#">61641</a>	4"	ABS PLUS PACK - w/ PLASTIC DOME ABS PLUS PACK - w/ ALUMINUM DOME	

	<a href="#">61561</a> <a href="#">61661</a>	<b>6"</b>	ABS PLUS PACK - w/ <b>PLASTIC DOME</b> ABS PLUS PACK - w/ <b>ALUMINUM DOME</b>
--	--	-----------	---

	<b>PARAPET/SCUPPER DRAINS</b>			
	NEW UPC PART NUMBER	SIZE	DESCRIPTION	LIST PRICE PER UNIT
	<a href="#">67301</a>	<b>2"</b>	CAST ALUMINUM SCUPPER DRAIN	
	<a href="#">67311</a>	<b>3"</b>	CAST ALUMINUM SCUPPER DRAIN	
	<a href="#">67321</a>	<b>4"</b>	CAST ALUMINUM SCUPPER DRAIN	

[Parapet/Scupper Drains Installation Instructions.](#)  
[CAD Page](#)

**PORTALS PLUS** 815 Kimberly Drive, Carol Stream, IL 60188

TEL: (800) 624-8642 FAX: (866) 466-9335

All information is subject to change without notice. Dimensions and specifications shown are within manufacturing tolerances.  
© Copyright Commercial Products Group of Hart & Cooley, Inc., January, 2009. All Rights Reserved.