

# CEILING AND WALL SYSTEMS

ALUMA VAULT CEILINGS



BEAM MATE CEILINGS



SKY MATE CEILINGS



CONTURA PERIMETER TRIMS



MILLENNIUM® CEILINGS



CUSTOM CEILINGS

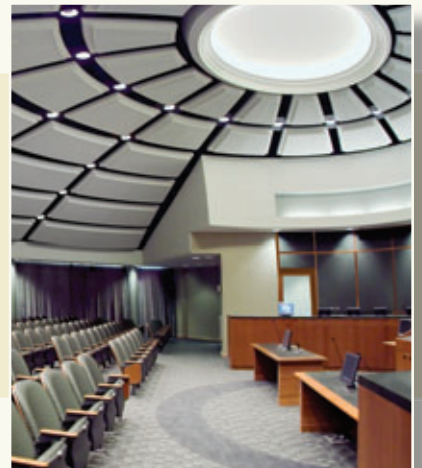



### ALUMA VAULT 3000

- 100% accessible, torsion panel system
- Convex, concave, undulating, or flat
- Custom engineered per your specification
- 1/8" thick, extruded aluminum concealed suspension
- Perforated or non-perforated panels per your specification
- Multiple perimeter options

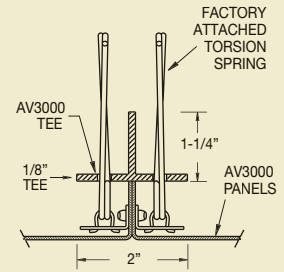

### ALUMA VAULT 1000, 2000, 2000R

- Convex, concave, undulating, or flat
- Lay-in perforated or non-perforated panels
- Module sizes per your specification
- Custom perforations available
- Multiple perimeter options

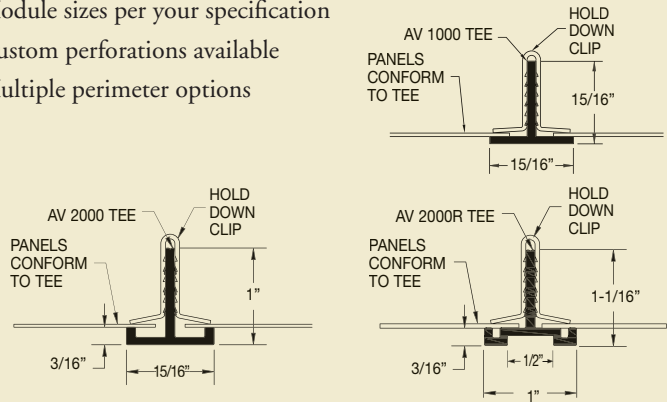

### BEAM MATE

- Numerous extruded aluminum beam sizes
- Module sizes per your specification
- Incorporate perforated or acrylic panels for a decorative effect
- Multiple perimeter options
- Track lighting options available
- Custom beam sizes can be created

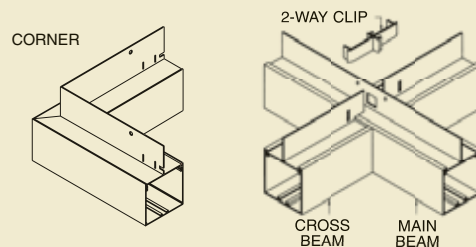

## LIGHT BEAM

- Extruded aluminum beam
- Can be factory wired for indirect lighting
- Module sizes per your specification
- Easy install clip system
- Continuous reveal options

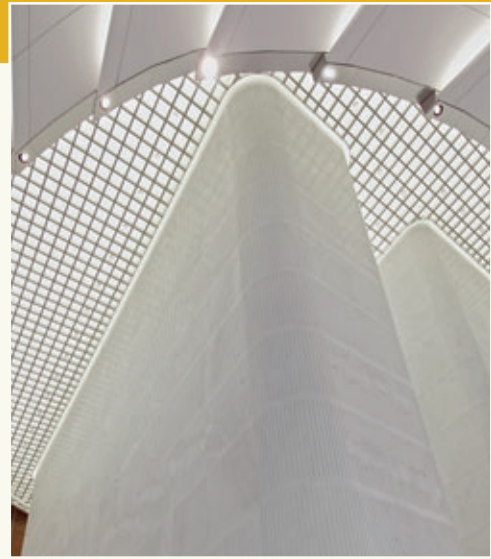
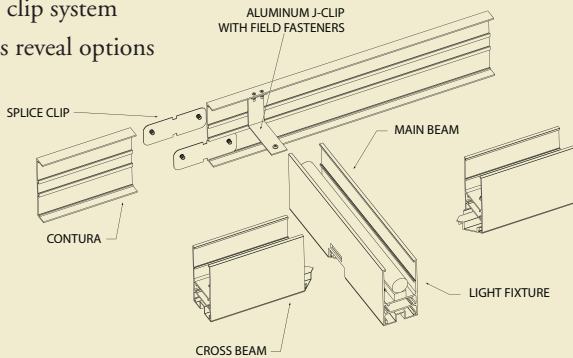

## GASKETED SUSPENSION - CG/RG

- Extruded aluminum tees
- Pharmaceutical, semiconductor, food processing, surgical suites, & aerospace applications
- Factory gasketed
- Custom applications

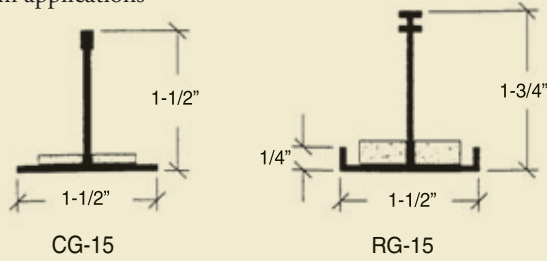

**CG-15**  
CG-10 – 15/16" Face x 1-1/2"  
CG-20 – 2" x 2"

**RG-15**

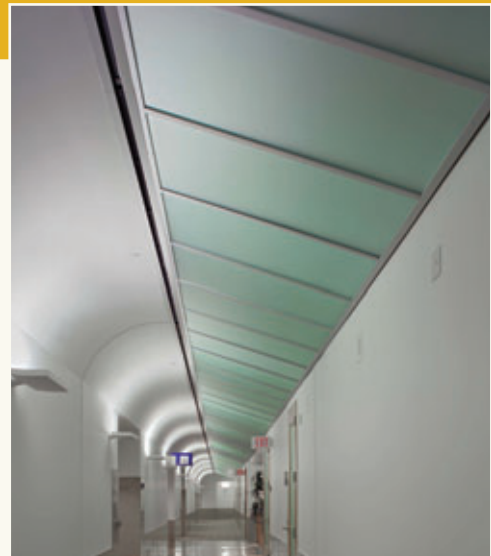

## COLUMN COVERS

- 12" minimum diameter
- 12' 0" maximum height before stacking
- MILLENNIUM®, aluminum, galvanized steel or stainless steel
- Horizontal, vertical or combination of reveals
- N-gage™<sup>1</sup> connection system
- ACROGUARD®-Super-durable, polyester powder coat factory finish

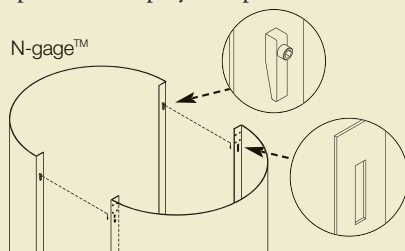

<sup>1</sup> N-gage™ patent number 6,148,585

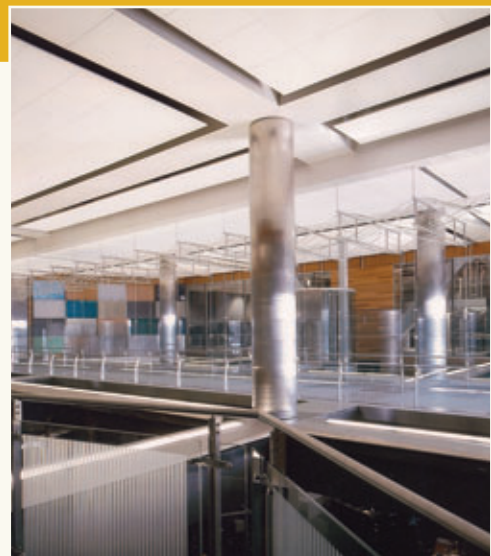



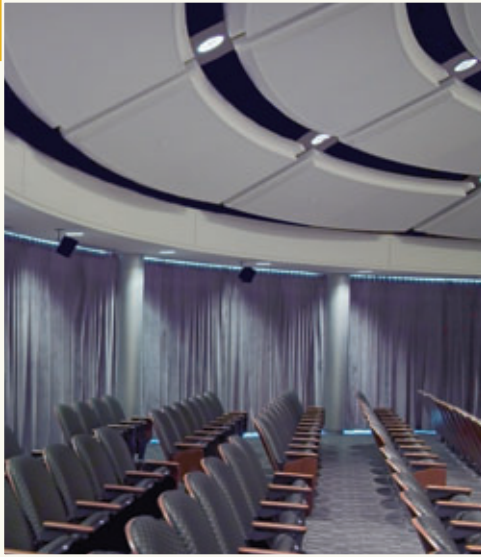

## COLUMN COLLARS

- Curved aluminum extrusions to trim columns or curved perimeters
- Acoustical or drywall profiles available
- Finished to match any suspension

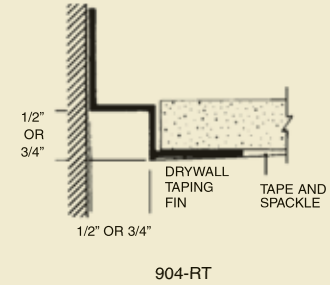
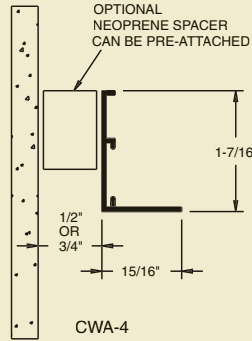

## CONTROL JOINTS

- Extruded aluminum
- Flexible PVC insert – stock white or special order in black or gray
- 1" or 2" sizes
- Pre-assembled for ease of installation
- Acoustical or drywall applications

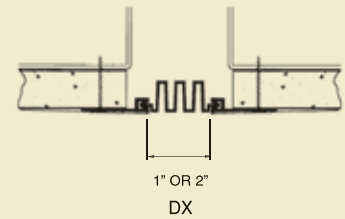
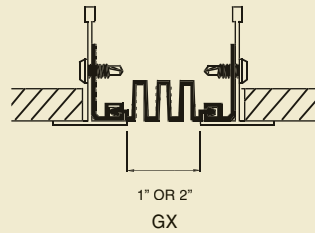

## CONTURA

- Extruded aluminum
- Use with any suspension system, beam ceilings or drywall ceilings
- Curved or straight
- Many acoustical or drywall profiles
- Knife Edge profiles – acoustical or drywall

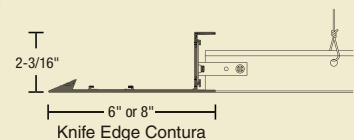
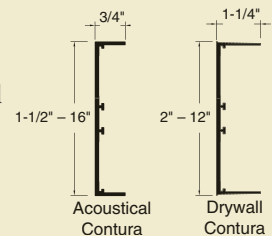
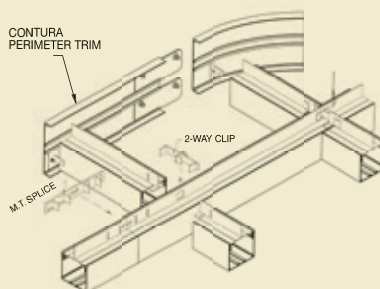

## FIN MATE

- Extruded aluminum
- Vertical blade baffle ceilings
- Various sizes available
- Integrates easily with any 15/16" suspension system
- Multiple ceiling configurations

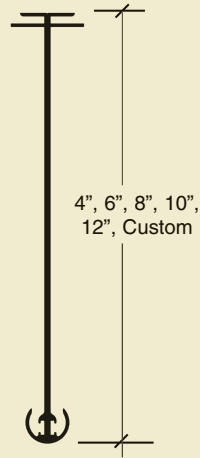
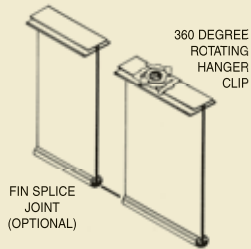

## FINAL FORMS

- Over 450 extruded aluminum profiles in stock
- Straight, curved, factory welded intersections, or custom fabricated
- Final Forms I drywall trims provided in alodine chemical coating for field painting or factory painted
- Final Forms II plaster trims provided in clear anodized finish or factory painted
- Custom profiles can be created to meet your design requirements

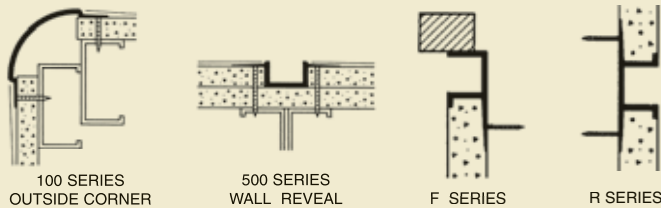

## LIGHT COVES

- Extruded aluminum
- Multiple profiles available
- Straight or curved applications
- Factory welded intersections and end caps available

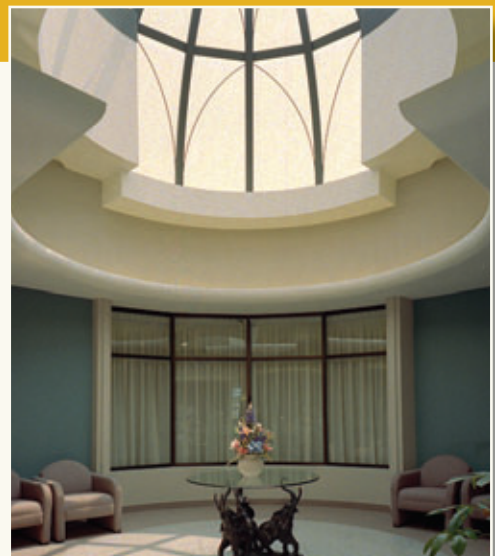
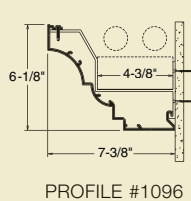
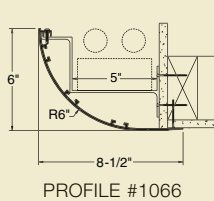
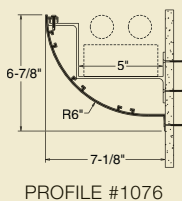
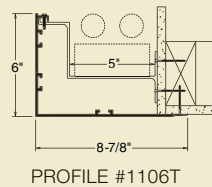

MILLENNIUM® 3-dimensional panels: 1/4" thick tubular appearance, approximately 40% open area



MILLENNIUM CEILINGS

- Convex, concave, undulating, corrugated or flat
- Multiple suspension options
- Up to 5' x 10' nominal module sizes
- Multiple perimeter options
- Acoustical
- Decorative
- Can be backlit
- Acoustical pads available

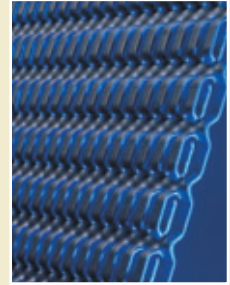

MILLENNIUM WALLS

- Flat, curved, or corrugated wall systems
- Multiple trim options
- Acoustical
- Decorative
- Can be backlit
- Acoustical pads available
- Non-woven acoustical fabric available

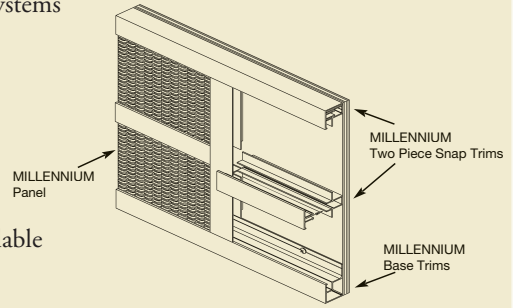

MILLENNIUM COLUMN COVERS

- 12" minimum diameter
- 12' 0" maximum height before stacking
- Acoustical
- Decorative
- Can be backlit
- Light diffuser available
- Horizontal, vertical or combination of reveals
- N-gage™<sup>1</sup> connector
- ACROGUARD® powder coat factory finish

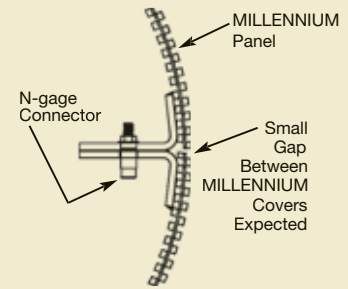

<sup>1</sup> N-gage™ patent number 6,148,585



MILLENNIUM ACOUSTICAL BAFFLES

- Use anywhere to reduce noise
- NRC = 1.05
- 46" nominal width x 48" tall typical
- Flush mounted to the wall
- Acoustical pads included
- Factory assembly available
- Custom heights available

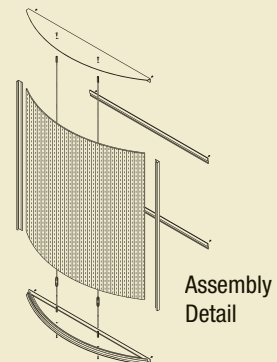



## MULLION MATE

- Spring loaded partition closure
- Insulation included for STC of 38
- Factory assembled and finished to match the mullion
- Custom lengths available
- Clear or medium bronze anodized, alodine for field painting or powder coated finishes available

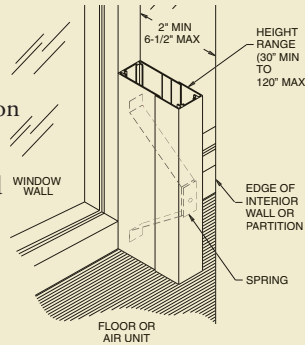

## PERIMETER POCKETS

- Ceiling transition to perimeter wall
- Ideal for concealing blinds, draperies, screens, air return or supply, and lighting
- Fits integrally with any acoustical or drywall ceiling systems
- Visually pleasing and less expensive than drywall construction
- Prefinished in the color of your choice
- Extruded or brake formed aluminum or brake formed steel

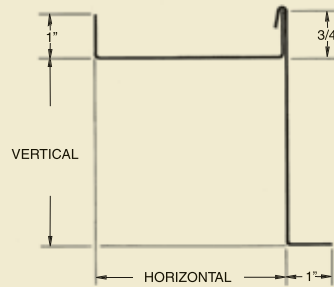

## ENVIRONMENTAL AND SERIES SUSPENSION

- Extruded aluminum
- Snap tab or clip systems
- Any module size
- Textured finishes available

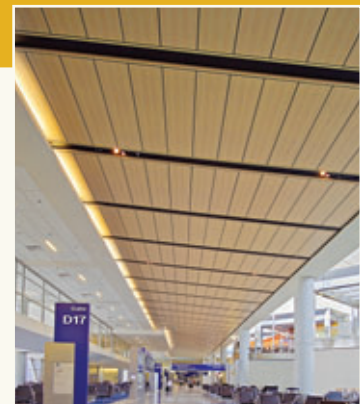
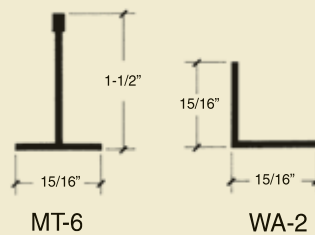
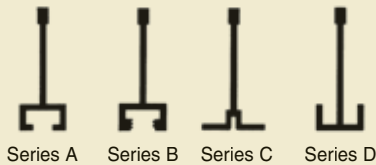

## SKY MATE

- Configurations: Square, rectangle, triangle, dome or custom
- Excellent natural skylight alternative
- Test assembled then disassembled prior to shipment
- Virtually any size available
- .080 matte white acrylic panels
- Custom panel options available

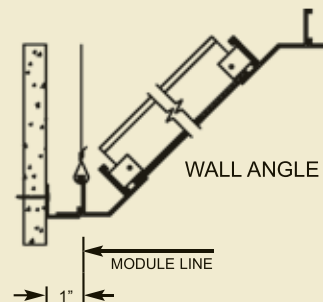

## FINISHES

- Acrylic “Wet” Paint
- Standard Powder Coat
- ACROGUARD® High Performance Powder Coat
- REVELATION™ Wood or Stone Powder Coat
- Kynar®<sup>2</sup>

## GREEN BY DESIGN

- LEED®<sup>3</sup> credits available
- 66% recycled aluminum
- 33% post consumer content
- 33% post industrial content
- No hazardous waste
- No VOC's
- No heavy metals

<sup>2</sup> Kynar is a registered trademark of ARKEMA, Inc.

<sup>3</sup> LEED is a registered trademark of the U.S. Green Building Council.

## FIN MATE CEILINGS



## COLUMN COVERS



## MILLENNIUM® WALLS



**GORDON**  
INTERIOR SPECIALTIES DIVISION

5023 HAZEL JONES ROAD, BOSSIER CITY, LA 71111

800.747.8954

800.877.8746 FAX

SALES@GORDONCEILINGS.COM

GORDONCEILINGS.COM

