

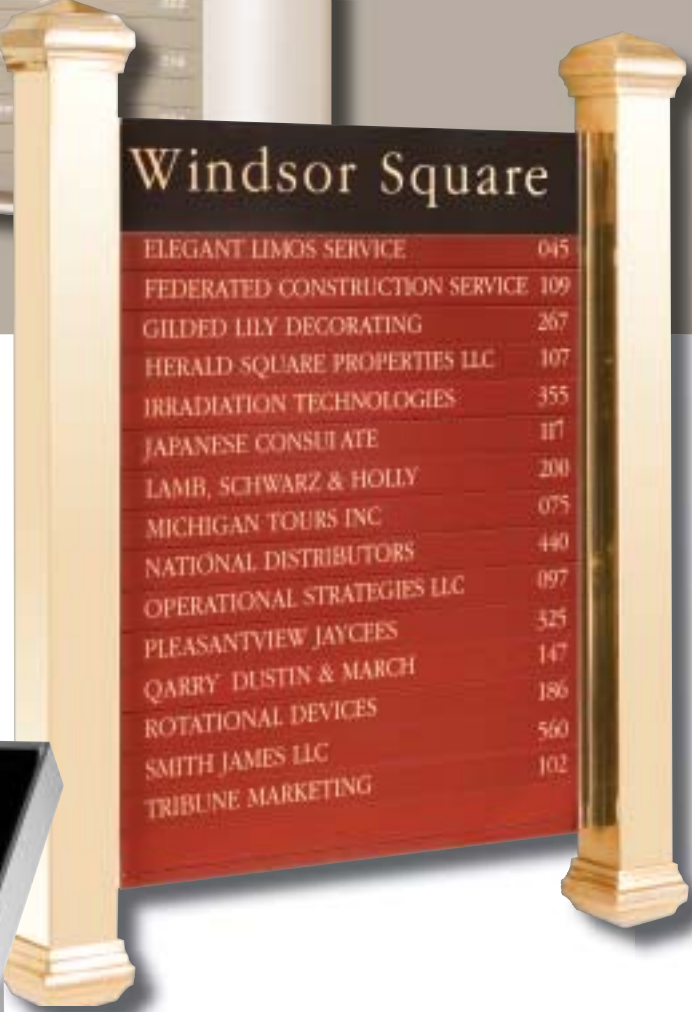

Directories
Bulletin Boards
Display Systems



Windsor Square

ELEGANT LIMOS SERVICE	045
FEDERATED CONSTRUCTION SERVICE	109
GILDED LILY DECORATING	267
HERALD SQUARE PROPERTIES LLC	107
IRRADIATION TECHNOLOGIES	355
JAPANESE CONSULATE	117
LAMB, SCHWARZ & HOLLY	200
MICHIGAN TOURS INC	075
NATIONAL DISTRIBUTORS	440
OPERATIONAL STRATEGIES LLC	097
PLEASANTVIEW JAYCES	325
QARRY DUSTIN & MARCH	147
ROTATIONAL DEVICES	186
SMITH JAMES LLC	560
TRIBUNE MARKETING	102



ABC Bulletin and Directory Division

Welton-Harkins



Nelson-Harkins

Directories
Bulletin Boards
Display Systems

Nelson-Harkins welcomes you to the most exciting new line of directories available today. These units are sure to be the industry standards of tomorrow.

Examine this catalog for the most extensive selection of building directories available anywhere. Creative design combined with functional simplicity has been the hallmark for each new directory system. You are sure to find a directory in the following pages to fulfill your exacting requirements.

For Nelson-Harkins complete catalog go to www.Nelson-Harkins.com

Index

Black-Out™ Directory Systems

224 Black-Out™ Series 3	
225 Black-Out™ Series 4	
227 Black-Out™ Series 5	
Pedistals	6
Info Black-Out™	7

Directories

254 Series	8
242 Series	9
259 Series	10
216 Series	11
250 Series	12
256 Series	13
Info Namestrips	14-15

Bulletin Boards

214 Series	16
217 & 247 Series	17
244 Series	18
241 Series	19
240 Series	20
245 Series	21
238 Series	22

Display Systems

248 Series	23
Information	24-25
Directouch 2000	26



Black-Out™ Directory Systems



Directories



Bulletin Boards



Display Systems

Nelson-Harkins Industries

5301 North Kedzie Avenue

Chicago, Illinois 60625

Phone 773 478.6243

FAX 773 478.8227

Toll Free 800 882.8989

Email nhi@nelson-harkins.com

Web www.nelson-harkins.com

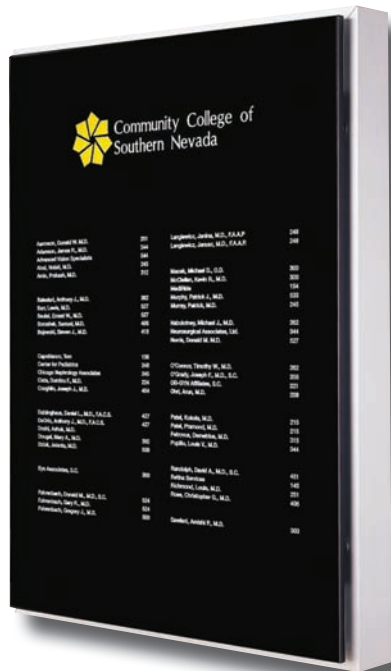

Construction Detail

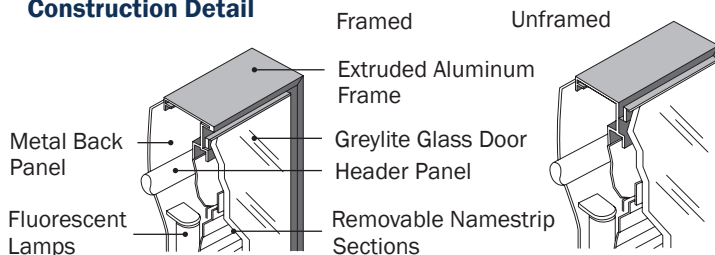

Options

- Unframed version
- Semi or fully recessed mounting
- Recess mounting lips in aluminum, bronze and stainless steel
- Pedestal bases (see page 6)
- Custom enclosures
- Film strips

Namestrips Engraved

Height x Width
3/8" x 7" or 11"
1/2" x 7" or 11" standard
5/8" x 7" or 11"
3/4" x 7", 11" or 18"
1" x 7", 11" or 18"
Imprinted Namestrip Service 3 to 5 days.

Sizes and Capacities

Number of Sections	Strip Capacity	Overall Width		
		1/2"	7"	11"
1	46	12 5/8"	16 7/8"	23"
2	92	19 7/8"	26 7/8"	40 7/8"
3	138	27 3/8"	37 7/8"	58 7/8"
4	184	34 7/8"	48 7/8"	76 7/8"
5	230	42 3/8"	59 7/8"	94 7/8"
6	276	49 7/8"	70 7/8"	
8	368	64 7/8"		

Standard Frame Height is 36"
Optional Heights 26" and 48"

Illuminated Interior Use



The 4" deep Model 224 is the solution when limited space is available. The 224 is designed to fit within standard wall joints, yet still provides the same features found on our 227 Black-Out™. This unit is available in both a framed and unframed version.

Construction

- Interior use only
- Extruded aluminum frame
- Frame: 3/8" face, 4" depth
- 1/4" Greylite 14% glazing
- High output cool white fluorescent illumination
- Concealed hinges and locking system
- 3" header with copy

Finishes

- Anodized:
- Clear Satin
 - Black
 - Dark Bronze
- Plated:
- Mirror Brass
 - Mirror Chrome

Graphics [Carriers]

- Film Carriers for:
- Maps, Logos
 - Color Photo
 - Transparencies
 - Duraclears

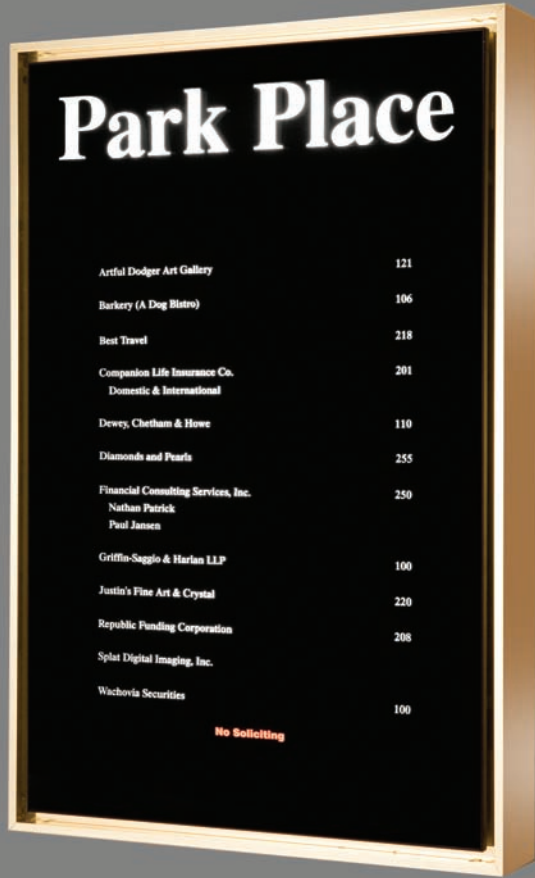

Illuminated Interior Use

Construction Detail

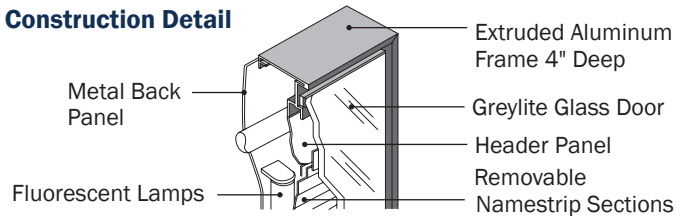

The 225 Series offers a Bright Silver/Bright Brass finish to the Black-Out™ directory system. These elegant high-end anodized finishes offer a cost effective alternative to expensive plated finishes. This 4" deep unit when surface mounted presents a bright frame finish with a attractive visual appeal.

Options

- Semi or fully recessed mounting
- Pedestal bases (see page 6)
- Custom enclosures
- Film strips

Namestrips Engraved

Height x Width
3/8" x 7" or 11"
1/2" x 7" or 11" standard
5/8" x 7" or 11"
3/4" x 7", 11" or 18"
1" x 7", 11" or 18"

Imprinted Namestrip Service 3 to 5 days.

Construction

- Interior use only
- Extruded aluminum frame
- Frame: 3/8" face, 4" depth
- 1/4" Greylite 14% glazing
- High output cool white fluorescent illumination
- Concealed hinges and locking system
- 3" header with copy

Finishes

- Anodized:
- Bright Silver
 - Bright Brass

Graphics [Carriers]

- Film Carriers for:
- Maps, Logos
 - Color Photo
 - Transparencies
 - Duraclears

Sizes and Capacities

Number of Sections	Strip Capacity	Overall Widths		
		1/2"	7"	11"
1	46	12 5/8"	16 7/8"	40 7/8"
2	92	19 7/8"	26 7/8"	58 7/8"
3	138	27 3/8"	37 7/8"	76 7/8"
4	184	34 7/8"	48 7/8"	94 7/8"
5	230	42 3/8"	59 7/8"	
6	276	49 7/8"	70 7/8"	
8	368	64 7/8"		

Standard Frame Height is 36"
Optional Heights 26" and 48"





227

Construction Detail

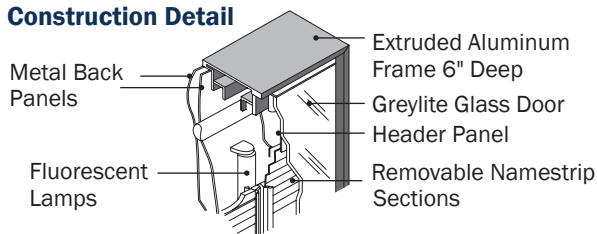

Options

- Semi or fully recessed mounting
- Recess mounting lips in aluminum, bronze and stainless steel
- Pedestal bases (see page 6)
- Custom enclosures
- Film strips

Namestrips Engraved

Height x Width
3/8" x 7" or 11"
1/2" x 7" or 11" standard
5/8" x 7" or 11"
3/4" x 7", 11" or 18"
1" x 7", 11" or 18"
Imprinted Namestrip Service 3 to 5 days.

Illuminated Interior Use



The Black-Out™ Directory Systems offer a spectacular visual effect. The unique floating graphic effect is achieved through a union of rear illumination, a patented namestrip holder and Greylite glazing. Manufactured to meet a wide variety of applications and finishes, the Black-Out™ will enhance any environment.

Sizes and Capacities

Number of Sections	Strip Capacity 1/2"	Overall Width		Strip Capacity 3/4"	Section 18"
		Section 7"	Section 11"		
1	46	12 5/8"	16 7/8"	30	23"
2	92	19 7/8"	26 7/8"	60	40 7/8"
3	138	27 3/8"	37 7/8"	90	58 7/8"
4	184	34 7/8"	48 7/8"	120	76 7/8"
5	230	42 3/8"	59 7/8"	150	94 7/8"
6	276	49 7/8"	70 7/8"		
8	368	64 7/8"			

Standard Frame Height is 36"
Optional Heights 26" and 48"

Construction

- Interior use only
- Extruded aluminum frame
- Frame: 3/8" face, 6" depth
- 1/4" Greylite 14% glazing
- High output cool white fluorescent illumination
- Concealed hinges and locking system
- 3" header with copy

Finishes

- Anodized:
- Clear Satin
 - Black
 - Dark Bronze
- Plated:
- Mirror Bronze
 - Bright Chrome

Graphics [Carriers]

- Film Carriers for:
- Maps, Logos
 - Color Photo
 - Transparencies
 - Duraclears



Base 5



Base 6



Base 3

Free Standing Directories

When free-standing directories are preferred, a variety of standard pedestal and post mount options are available.



Base 2



Base 1

Black-Out™ Namestrip Format



Second Indent
First Indent
Flush Left Margin

Namestrip Sizes



Available widths: 11" and 18"



Available widths: 11" and 18"



Available widths: 7", 11" and 18"



Available widths: 7", 11" and 18"



Available widths: 7", 11" and 18"

Finishes

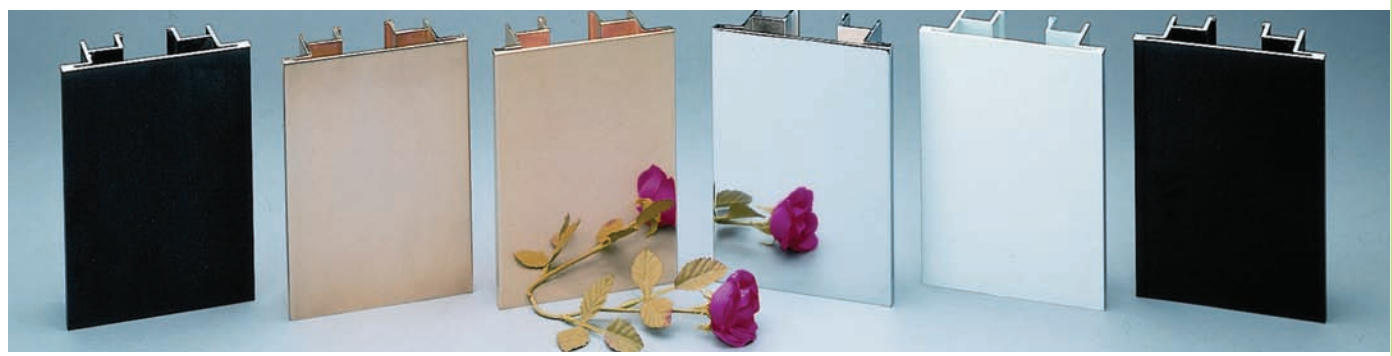

Dark Bronze Anodized Satin Bronze Plated Mirror Bronze Plated Mirror Chrome Plated Satin Anodized Black Anodized

Rear-Illuminated Namestrips

Standard Black-Out™ Profile	Film Strip Profile [Optional]
Standard Heights: 3/8", 1/2", 5/8", 3/4", and 1"	Standard Height: 5/8" overall to accept 1/2" Film Negative Insert

Info

Letter Styles

ABCDEFabcdef1234
ABCDEFabcde1234
ABCDEFabcdefg1234
ABCDEabcdefgh1234
ABCDabcdef1234
ABCDEFabcdefg12345

- Fonts available include:
- Helvetica Family
 - Futura
 - Optima
 - Times Roman
 - Clarendon
 - Goudy

Nelson-Harkins
Black-Out™ Directories

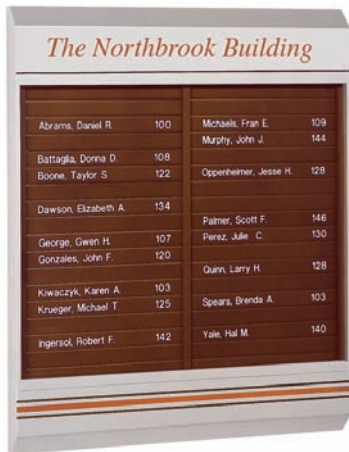
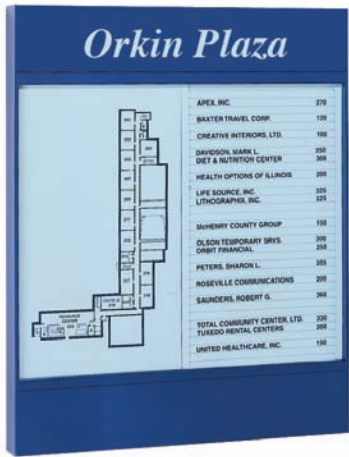

Non-Illuminated Interior Use

The 254 Series is designed as a non-illuminated directory system with a unique visual appeal. Offered in a variety of frame profiles, the 254 is sure to have the look to match your environment. Easy to replace namestrips are accessible from under a clear removable lens.

Construction

- Interior use only
- Frame: 4" face, 2" depth
- Frame profiles: square, radius, beveled
- Clear acrylic lift-off lens
- Easy changeable namestrip system with Messagetrack™
- Header

Finishes

Acrylic Polyurethane Colors:
See page 25 for available frame and strip colors

Graphics

- Map and Logo graphic Carriers
- Custom Layouts

Namestrips Reveal strip

- Height x Width
- 1/2" x 10" standard
- 3/4" x 10"
- 1" x 10"
- 3/4" x 15"
- 1" x 15"

Options

- 24" and 48" heights
- Graphic and Map holders
- Custom PMS frame colors

Construction Detail

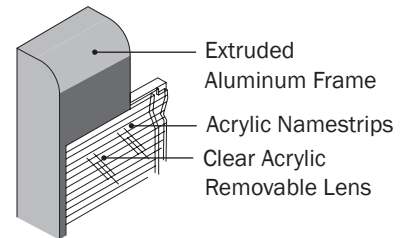

Frame Profiles

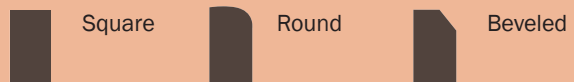

Sizes and Strip Capacities

Number of Columns	Strip Capacity 1/2"	Strip Capacity 3/4"	Strip Capacity 1"	10" Strip Unit Width	15" Strip Unit Width
2	108	72	54	22"	26 1/8"
3	162	108	81	32 1/2"	47 3/4"
4	216	144	108	43"	63 1/4"

Standard Frame Height is 36"

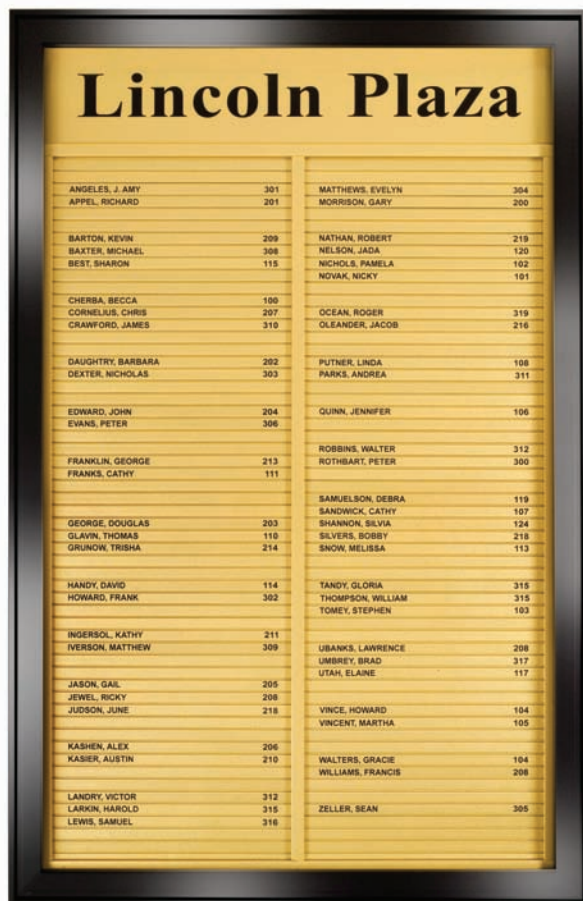

Nelson-Harkins

Series

242

Construction Detail

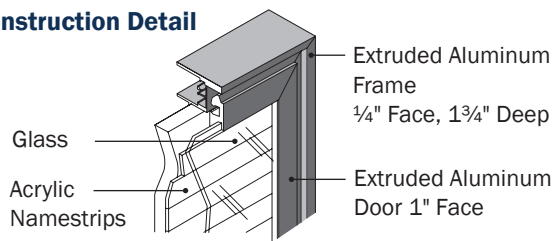

Sizes and Capacities

Number of Columns	Strip Capacity 1/2"	Strip Capacity 3/4"	Strip Capacity 1"	Directory Size W" x H"
1	24	16	12	13 x 18
1	36	24	18	13 x 24
1	60	40	30	13 x 36
1	80	52	40	13 x 48
2	48	32	24	23 1/4 x 18
2	72	48	36	23 1/4 x 24
2	120	80	60	23 1/4 x 36
2	160	106	80	23 1/4 x 48
2	180	120	90	33 1/2 x 36
3	240	160	120	33 1/2 x 48

Non-Illuminated Interior Use



The 242 Series provides a contemporary non-illuminated namestrip directory. A minimal frame enhances the overall visual appearance. The 242 Series is well suited to the small building lobby directory or floor directory in a larger facility. The MessageTrack™ system provides movable easy sliding namestrips front snap-in/out replacement.

Construction

- Interior use only
- Extruded aluminum frame
- Frame: 1/4" face, 1 3/4" depth
- Double strength 1/8" clear glass
- Acrylic extruded namestrips
- Concealed hinges
- 3" header with copy

Finishes

- Anodized:
- Clear Satin
 - Black
 - Dark Bronze
 - Bright Silver
 - Bright Brass
- Acrylic Polyurethane Colors

Namestrips Reveal strip

Height x Width
1/2" x 10" standard
3/4", 1" x 10" optional

Options

- Map and logo panels available
- Custom Graphics
- With or without header
- Recess mounting
- Custom PMS frame colors



**Non-Illuminated
Interior Use**

The 259 Series with its unique curved face results in the maximum viewing angle in a unrivaled and contemporary design. Access is easy with removal of a clear lens make this a new industry standard.

Construction

- Interior use only
- Frame: 4" face, 2" depth
- Clear acrylic lift-off lens
- Easy changeable namestrip system with Messagetrack™
- Header

Graphics

- Map and Logo graphic Carriers
- Custom Layouts

Options

- 24" and 48" heights
- Graphic and Map holders
- Custom PMS frame colors

Finishes

Acrylic Polyurethane Colors:
30 Standard
Polyurethane Colors
(see page 25)

Namestrips Reveal strip

Height x Width

½" x 10"

¾" x 10", 15"

1" x 10", 15"

¾" x 15"

1" x 15"

1½" x 15"

Construction Detail

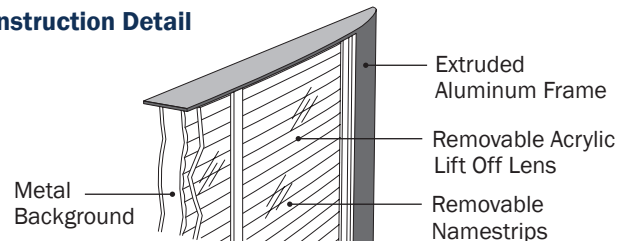

Cover Profiles

Square

Sizes and Capacities

Number of Columns	Strip Capacity ¾"	Strip Capacity 1"	Strip Capacity 1½"	10" Strip Unit Width	15" Strip Unit Width
1	40	30	20	19½"	24½"
2	80	60	40	30"	40"
3	120	90	60	40½"	55½"
4	160	120	80	51"	

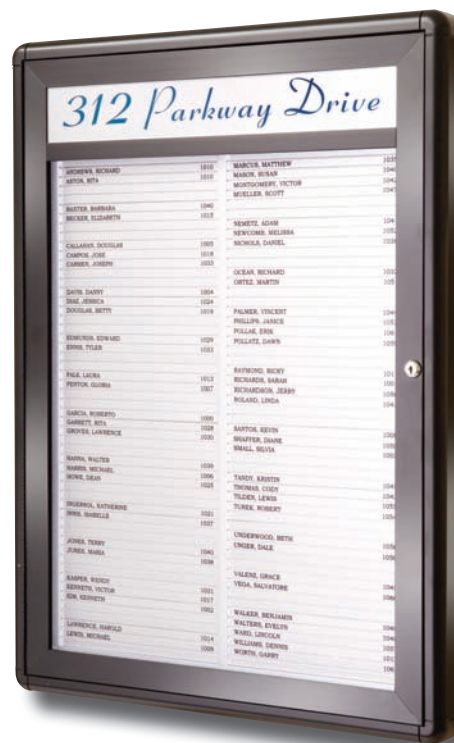

Construction Detail

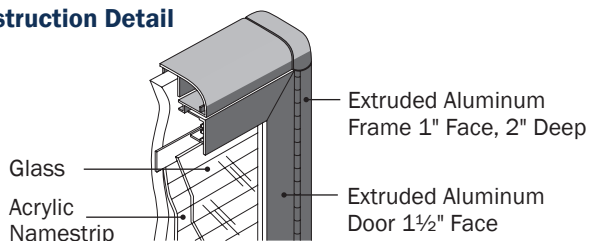

Sizes and Capacities

Number of Columns	Strip Capacity ½"	Strip Capacity ¾"	Strip Capacity 1"	Directory Size W" x H"
1	30	20	15	16 x 24
1	48	32	24	16 x 36
1	80	53	40	16 x 48
2	60	40	30	26½ x 24
2	96	64	48	26½ x 36
2	160	106	80	26½ x 48
3	90	60	45	37 x 24
3	144	96	72	37 x 36
3	240	159	120	37 x 48

Non-Illuminated Interior Use



The contemporary styling of this non-illuminated namestrip directory system will enhance any building's lobby. The 216 Series features a rounded aluminum extruded frame with radius corners. Combined with Messagetrack™, the movable namestrip system provides easy sliding namestrips and front snap-in/out replacement—a directory system whose time has come.

Construction

- Interior use only
- Extruded aluminum frame
- Frame: 2½" face, 2" depth
- Double strength plate glass glazing
- 3" header standard
- Messagetrack™ namestrip system

Finishes

Standard Polyurethane Colors (see page 25)

Namestrips Engraved

Height x Width
½" x 10" standard
¾", 1" x 10" optional

Options

- 24" and 48" heights
- Graphic map carriers available
- Custom sizes and layouts
- Custom PMS frame colors
- 30 standard strip colors see page 25
- Custom colors available
- Easy replacement system

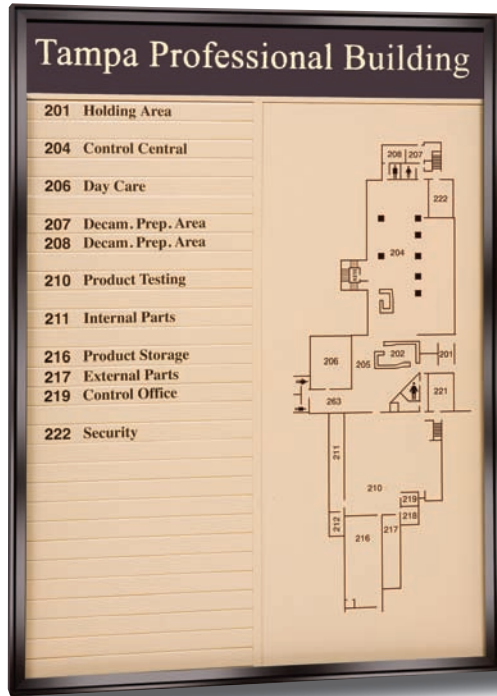

**Non-Illuminated
Interior Use**

The Director is a versatile namestrip, graphic map, or combination directory. The lift-off frame covers one or two columns of acrylic namestrips in the easy changeable Messagetrack™ system. The thin profile frame combined with a 4" high header provides a distinctive visual appeal.

Construction

- Interior use only
- Extruded aluminum frame
- Frame: ¾" face, 1½" overall depth
- Clear Acrylic glazing
- Messagetrack™ namestrip system with easy to change message strips

Namestrips Reveal strip

Height x Width

1" x 13", 18"

1 ½" x 13", 18"

Finishes

Anodized:
Clear Satin
Black
Dark Bronze

Options

- Graphics and Map graphic panels
- Custom PMS frame colors

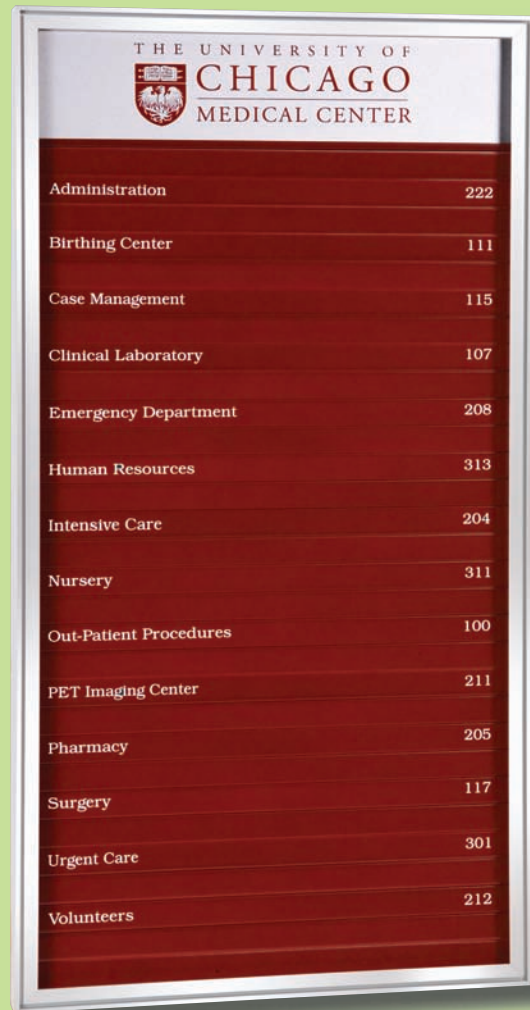

Construction Detail

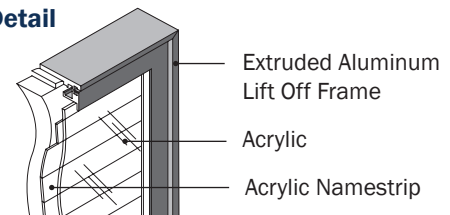

Sizes and Capacities

Overall Size Width x Height	Number of Columns	Strip Capacity 1" High	Strip Capacity 1½"	Namestrip Width
13½" x 28"	1	22	14	13"
13½" x 36"	1	30	20	13"
26½" x 26"	2	44	28	44"
26½" x 36"	2	60	40	13"
18½" x 28"	1	22	14	18"
18½" x 36"	1	30	20	18"
36½" x 28"	2	44	28	18"
36½" x 36"	2	60	40	18"

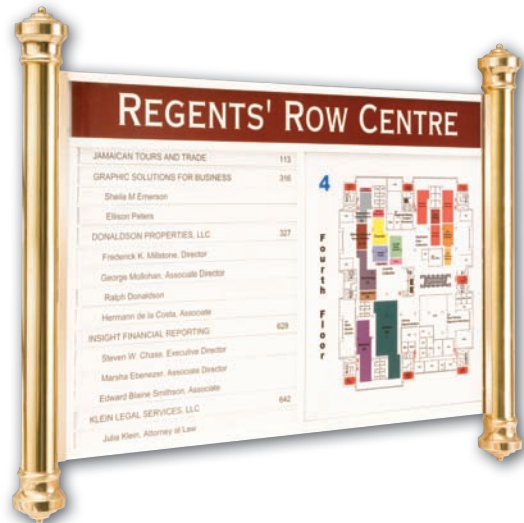
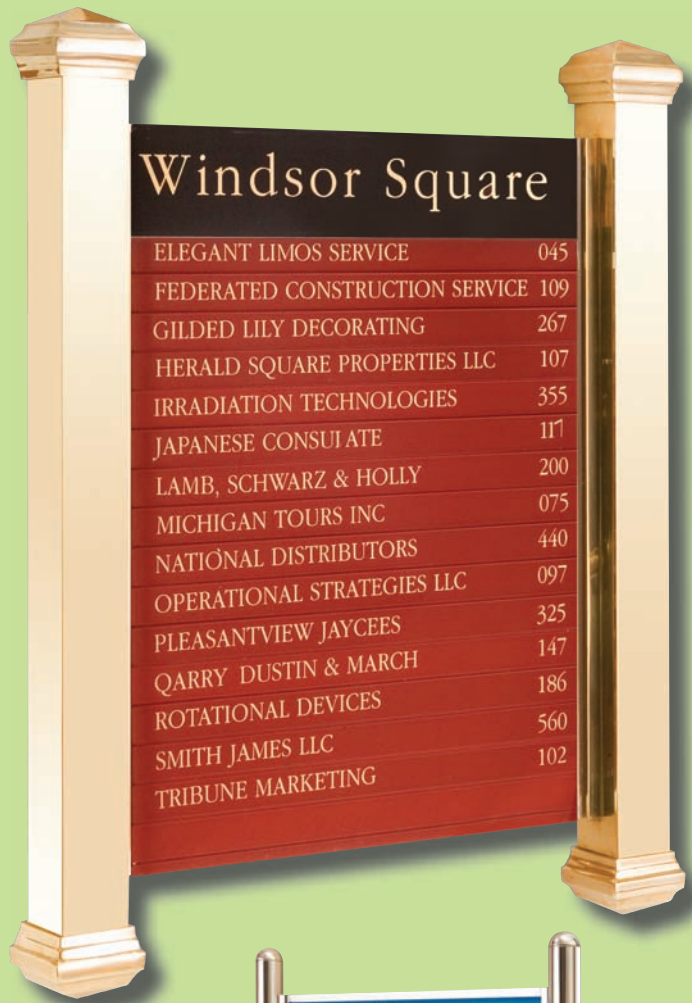

Non-Illuminated
Interior Use



The 256 is simple yet elegant with brass or chrome accenting. This unit is standard with 5/8" user updateable strips that user prints on paper. A lift off metal frame with clear acrylic lens provides security.

Construction Detail

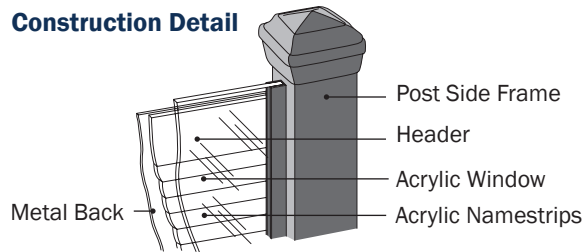

Sizes and Capacities

Number of Columns	Strip Capacity	Strip Capacity	Strip Width	Strip Width
	5/8"	1 1/8"	10"	15"
1	36	20	15" ±	20" ±
2	72	40	25" ±	35" ±

Standard Frame Height is 30"

Construction

- Interior use only
- Lift-off clear cover
- User updateable white namestrips for paper inserts

Finishes

Chrome or Brass

Namestrips

Height x Width
5/8" x 10" for 1/2" insert
1 1/8" x 15" for 1" insert

Options

- Colored namestrips for engraved or vinyl letters
- Graphic map

Reveal strips optional

Namestrip Format



Non-Illuminated Namestrips

Reveal Strip Profile

Standard Heights:
 $\frac{1}{2}$ ", $\frac{3}{4}$ ", 1", and $1\frac{1}{2}$ "
 30 standard Colors—
 (see page 25)
 Core color is White
 or Black

Square Cut Profile

Standard Heights:
 $\frac{1}{2}$ ", $\frac{3}{4}$ ", 1", and $1\frac{1}{2}$ "
 Primary Colors Only
 Core color is White
 or Black

Window Strip

Patent Pending
 (User Updateable)
 Standard Heights:
 $\frac{5}{8}$ " (for $\frac{1}{2}$ " insert);
 $1\frac{1}{8}$ " (for 1" insert)
 Unique, one-piece
 design
 Window Strips are
 white with crystal
 clear acrylic window
 to view paper insert
 through.
 Software available.

Namestrip Sizes



Available widths: 15" and 18"



Available widths: 10", 11", 13", 15" and 18"



Available widths: 10", 11", 13", 15" and 18"



Available widths: 10", 11", 13", 15" and 18"

Finishes

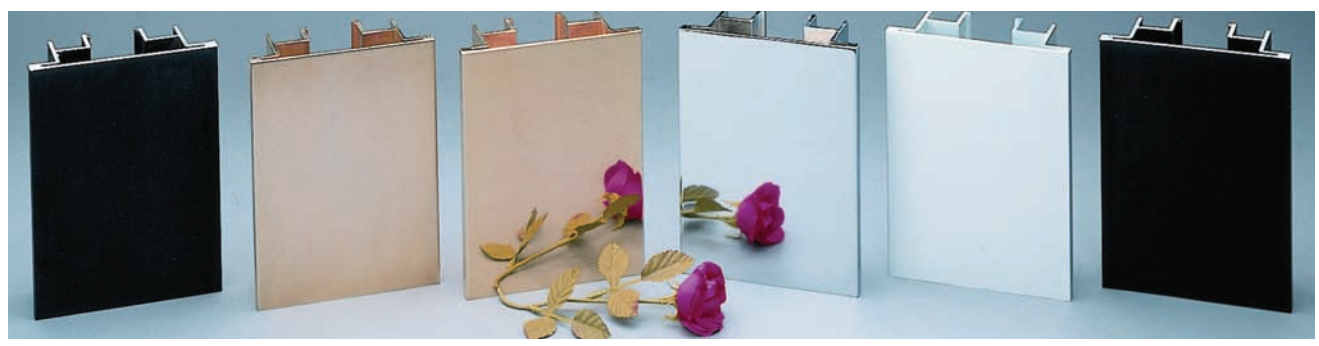

Dark Bronze Anodized Satin Bronze Plated Mirror Bronze Plated Mirror Chrome Plated Satin Anodized Black Anodized

Namestrip Format and Profiles

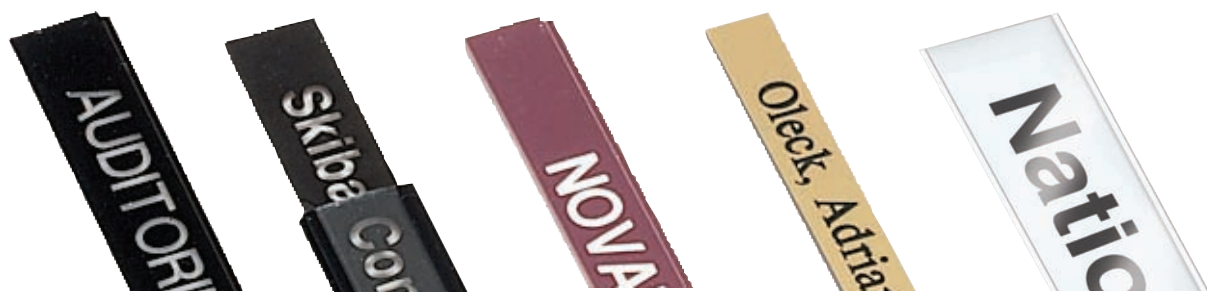

Black -Out Film Strip Reveal Strip Square Cut Window Strip

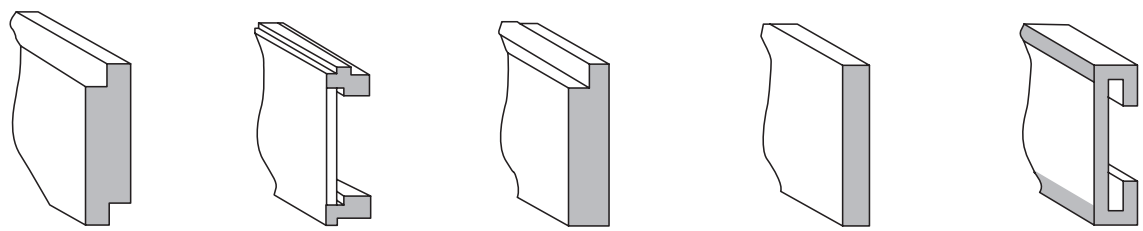

Rear-Illuminated Namestrips

Letter Styles

- Fonts available include:
- Helvetica Family
- Futura
- Optima
- Times Roman
- Clarendon
- Goudy

ABCDEFGHIJKLMNOPQRSTUVWXYZabcdefghijklmnopqrstuvwxyz1234567890
ABCDEFGHIJKLMNOPQRSTUVWXYZabcdefghijklmnopqrstuvwxyz123456789
ABCDEFGHIJKLMNOPQRSTUVWXYZabcdefghijklmnopqrstuvwxyz1234567890
ABCDEFGHIJKLMNOPQRSTUVWXYZabcdefghijklmnopqrstuvwxyz1234567890
ABCDEFGHIJKLMNOPQRSTUVWXYZabcdefghijklmnopqrstuvwxyz123456789
ABCDEFGHIJKLMNOPQRSTUVWXYZabcdefghijklmnopqrstuvwxyz1234567890



**Non-Illuminated
Interior Use**

The graceful 214 Series offers maximum flexibility in a directory/bulletin board system. The unique rounded frame with radius corners accents with a variety of background options. The extruded aluminum door provided with a continuous hinge and key lock.

Construction

- Interior use only
- Extruded aluminum frame
- Frame: 2½" face, 2" depth
- Double strength plate glass

Finishes

Acrylic Polyurethane Colors:
30 Standard Colors
(see page 25)

Options

- Single or double door
- Header with copy
- Custom sizes
- Custom PMS frame colors
- Changeable letters
(see page 24)

Backgrounds

- Felt grooved for changeable letters
- Tan cork
- Cork with premium fabric covering (see page 24)
- Magnetic metal

Construction Detail

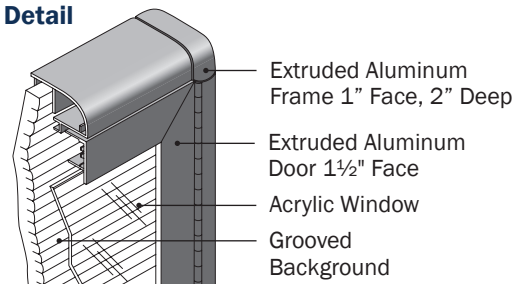

Sizes (Width x Height)

Single Door	Double Door
18" x 24"	48" x 36"
24" x 30"	60" x 36"
24" x 36"	72" x 36"
30" x 36"	60" x 48"
36" x 36"	72" x 48"
36" x 48"	96" x 48"



217 Series



247 Series

**Non-Illuminated
Interior Use**



Construction Detail 217

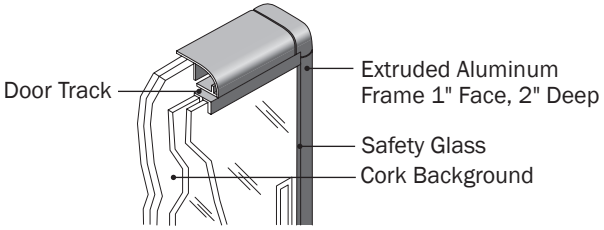

Construction Detail 247

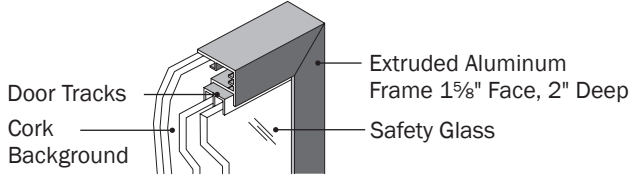

Sizes (Width x Height)

48" x 36"	60" x 48"
60" x 36"	72" x 48"
72" x 36"	96" x 48"
96" x 36"	

The 217 Series, a sliding glass door system provides a large unobstructed viewing area. The rounded frame with radius corners creates a contemporary appearance. The safety glass doors are provided with rolling tracks, finger pulls, and display lock. Offered with a choice of backgrounds, this system adds elegant appearance to any environment.

The 247 Series sliding glass door directory features uninterrupted viewing and easy access to display area. A choice of cork or felt grooved backgrounds is available in a variety of colors. The safety glass doors slide smoothly on rollers complete with finger pulls and display lock.

217/247 Construction

- Interior use only
- Non-illuminated
- Surface mount
- Extruded aluminum frame
- 217 Series
Frame: 1" face, 2" depth
- 247 Series
Frame: 1.5" face, 2" depth

Finishes

- 217 Series
Acrylic Polyurethane Colors:
30 Standard Colors
(see page 25)
- 247 Series Anodized:
Silver
Black
Dark Bronze

Options

- Custom PMS frame colors
- Changeable letters
(see page 24)

217/247 Backgrounds

- Tan cork
- Cork covered with premium fabric
- Felt grooved background for changeable letters
(see page 24)



Functional design and sturdy construction make the 244 Series a favorite as a multi-purpose directory/bulletin board. Available in one, two, or three door models, the background can combine to fit your specific needs. An optional header is available with copy of your choice, interior construction is standard; exterior construction optional.

Construction

- Interior and exterior use
- Extruded aluminum frame
- Frame: 3½" face, 2" depth
- Non-illuminated
- Surface or recess mount

Options

- 3" Header with copy in standard style
- Posts for freestanding mount
- Custom PMS frame colors
- Changeable letters (see page 24)

Finishes

- Anodized:
- Clear Satin
 - Black
 - Dark Bronze
- Standard Colors
- Acrylic Polyurethane Colors (see page 25)

Backgrounds

- Felt grooved (interior use)
- Vinyl grooved (exterior use)
- Cork with fabric covering (see page 24)
- Tan cork

Non-Illuminated Interior and Exterior Use



Construction Detail

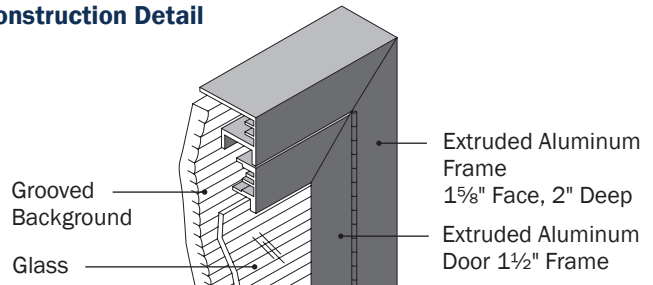

Sizes (Width X Height)

Single Door	Double Door	Triple Door
18" x 24"	48" x 36"	72" x 36"
24" x 30"	60" x 36"	72" x 48"
24" x 36"	60" x 48"	96" x 48"
28" x 40"	72" x 36"	
32" x 44"		
36" x 48"		



Construction Detail

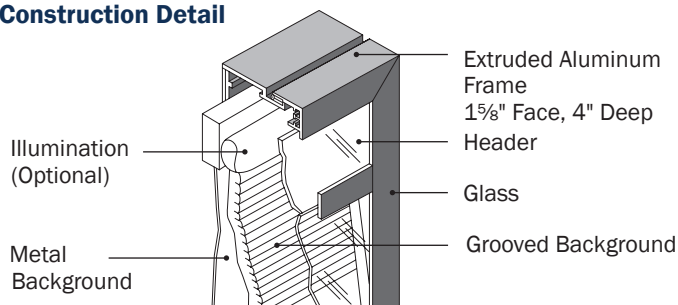

Illuminated, Non-Illuminated Interior and Exterior Use



Sizes (Width X Height)

18" x 24"	36" x 48"
24" x 30"	42" x 48"
24" x 36"	48" x 48"
30" x 40"	60" x 48"
36" x 36"	72" x 48"

The 241 Series offers a seamless thin face profile yet is suitable for both interior and exterior use. With unique concealed hinge system, and sidewall lock this single frame face provides a minimal look contemporary feel. The 4" deep non-illuminated unit offers a variety of background options mount either surface or semi-recessed.

Construction

- Interior and exterior use
- Frame: 1 5/8" Face, 4" Depth
- Non-illuminated
- Surface or semi-recessed mount

Finishes

- Anodized:
 - Satin
 - Black
 - Dark Bronze
- Acrylic Polyurethane Colors (see page 25)

Models

- 241-N Non illuminated
- 241-I Illuminated

Styles

- Custom PMS frame colors
- Changeable letters (see page 24)

Options

- 3" Header with copy in standard styles



If you are looking for a directory with a minimal face profile, the 240 Series is perfect. With only a 1 $\frac{3}{8}$ " frame, it provides the solution. The fixed outside frame features an inset continuous hinged door with lock. Suitable for either surface or recessed mounting, the 240 Series offers a variety of coordinated colors for both cork or felt grooved backgrounds.

Construction

- Interior and exterior use
- Extruded aluminum frame
- Frame: 1 $\frac{3}{8}$ " face, 2" depth
- Surface or recess mount

Backgrounds

- Felt grooved for changeable letters
- Tan cork
- Cork with premium fabric covering (see page 24)
- Magnetic metal

Finishes

Anodized:

- Clear Satin
- Black
- Dark Bronze

Acrylic Polyurethane Colors (see page 25)

Options

- Header with copy
- Custom PMS frame colors
- Changeable letters (see page 24)
- Recessed Lip

Construction Detail

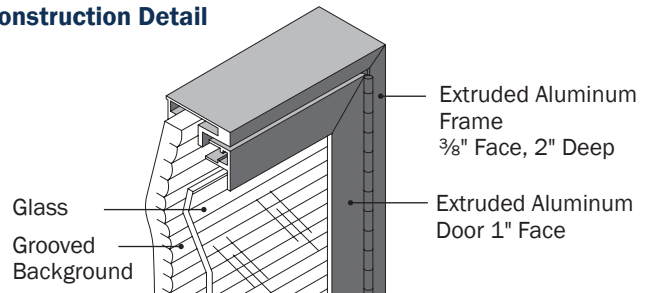

Non-Illuminated Interior and Exterior Use



Sizes (Width x Height)

18" x 24"	28" x 40"
24" x 30"	32" x 44"
24" x 36"	36" x 48"



Construction Detail

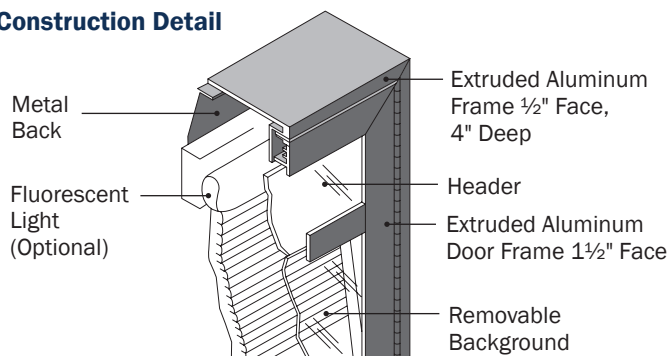

Illuminated, Non-Illuminated Interior and Exterior Use



Sizes (Width x Height)

20" x 30"	36" x 48"
24" x 30"	42" x 48"
24" x 36"	48" x 48"
30" x 40"	60" x 48"
36" x 36"	72" x 48"

For both interior and exterior use, the 245 Series offers great versatility. Options such as illumination, freestanding posts, and headers are available to meet your specific needs. The 245 Series heavy-duty aluminum construction provides years of unsurpassed durability.

Construction

- Interior and exterior use
- Extruded aluminum frame
- Frame: 2" face, 4" depth
- Continuous hinged door with key lock
- Double strength glass glazing

Finishes

- Anodized:
- Clear Satin
 - Black
 - Dark Bronze
- Acrylic Polyurethane Colors (see page 25)

Backgrounds

- Felt grooved for changeable letters (interior)
- Vinyl grooved for changeable letters (exterior)
- Tan cork

Options

- Illumination
- Copy header
- Posts for freestanding mount
- Custom PMS frame colors
- Changeable letters (see page 24)
- Recess mounting

Models

- 245-N Non illuminated
- 245-I Illuminated

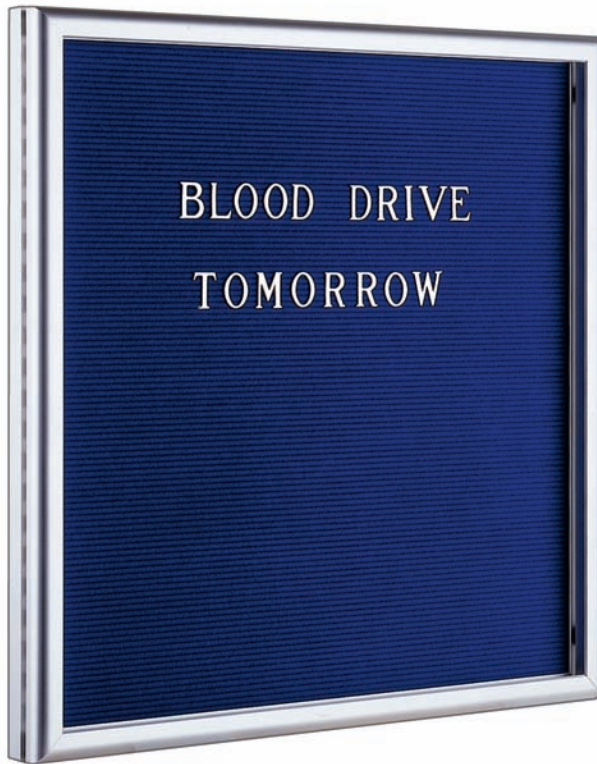

A truly contemporary appearance offered in this bulletin board series. The 238 Series is available in three profile frames each with its own distinctive look. It is in both a felt grooved background for changeable letters or cork/tack background.

Construction

- Interior use only
- Extruded aluminum frame
- Frame: 1¼" face, 2¼" depth

Backgrounds

- Tan cork
- Felt grooved for changeable letters (see page 24)
- Cork with premium fabric covering (see page 24)
- Graphic panel for maps and logos

Frame Profiles

Square: 238S
Round: 238R
Beveled: 238B

Finishes

Anodized:
Clear Satin
Black
Dark Bronze
Acrylic Polyurethane Colors
(see page 25)

Options

- Header with graphics
- Custom sizes available
- Graphic/map panel
- Custom PMS frame colors

Construction Detail

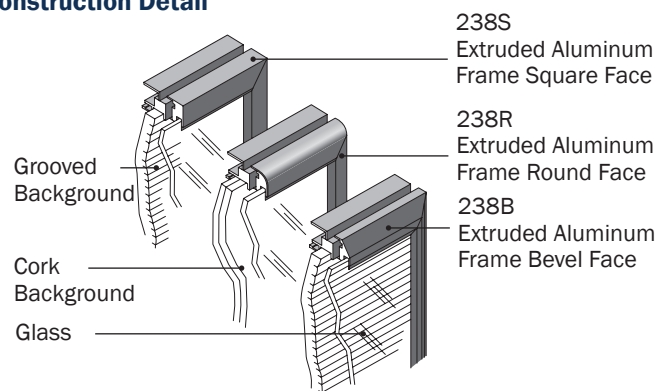

Non-Illuminated Interior Use



Sizes (Width x Height)

24" x 36"	30" x 36"	36" x 36"
24" x 40"	30" x 40"	36" x 48"
24" x 48"	30" x 48"	



The 248 Series graceful appearance is perfect as an exterior changeable letter message center. A church, school, or community center will find the easy changeable letter background system the ideal unit for getting your message to the public.

Construction Detail

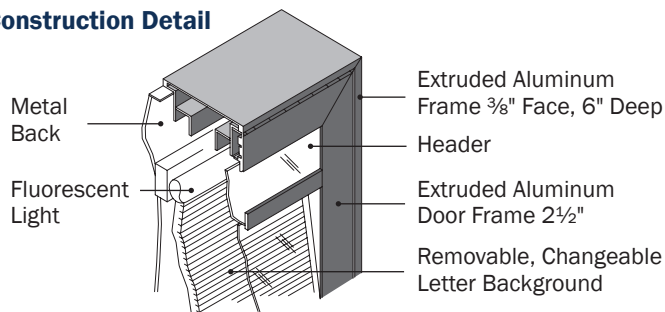

Internal Illumination Exterior Use



Sizes (Width x Height)

48" x 36"	60" x 36"	72" x 48"
54" x 36"	60" x 42"	96" x 48"
54" x 42"	60" x 48"	

Construction

- Exterior use
- Extruded aluminum frame
- Internal top illumination
- 3" high header with copy
- Surface mount
- Frame: 3" Face, 6" Depth

Finishes

- Anodized:
- Clear Satin
 - Black
 - Dark Bronze
- Acrylic Polyurethane Colors (see page 25)

Backgrounds

- Vinyl grooved for changeable letters (see page 24)
- Tan cork

Options

- Single or double face
- Freestanding posts

**Felt Colors
for Changeable Letters**



Red



Green



Blue



Burgundy



Black



Beige



Aqua



Grey



Orange



Brown

**Fabric Covered
Cork Backgrounds**

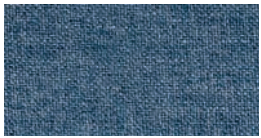

Wedgewood



Wheat

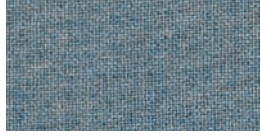

Aqua



Light Grey



Lavender



Apricot

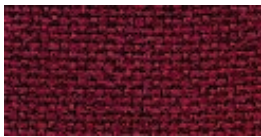

Deep Burgundy



Dark Grey



Black

Changeable Letters and Figures Styles (White)

Gothic

1/2" 3/4" 1" 1 1/2" 2"

Helvetica

1/2" 3/4" 1" 1 1/2" 2"

Roman

1/2" 3/4" 1" 1 1/2" 2" 3"

Standard Letters and Figures

300 font with storage box



Gothic
Helvetica
Roman

Acrylic Polyurethane
Finishes



10209 Red



10211 Yellow



28073 Blue

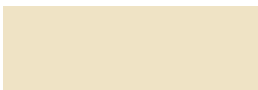

25833 Bone White



24510 Green



11477 White



30133 Gold



30135 Copper



24161 Copper



Dark Bronze

Acrylic Polyurethane
Finishes



10221 Burgundy



25851 Blue



24100 Blue



25849 Grey



10225 Green



30132 Black



30134 Gold



30136 Gold



15720 Medium Bronze



Acrylic Polyurethane
Finishes



23966 Red



25771 Blue



25550 Purple



10217 Brown



25066 Green



23906 Orange



10212 Blue



25829 Beige



25900 Cream



25836 Grey

Color Chart

Please note the printed colors may not be totally accurate due to printing limitations.



Computer Directory System for a New Century

Directouch 2000 is a new computerized directory system from Nelson-Harkins, the nation's leading directory manufacturer. This innovative new system developed by Nelson-Harkins and TTSS Interactive Products is specifically for the office building market. The Directouch 2000 is loaded with the features you are looking for at a price you can afford. The 15" touch-sensitive screen is available in a traditional monitor, flat screen, or through-glass version. This state-of-the-art unique visual presentation includes your building's picture, listings by companies and individuals, the time and date as well as bulletin board feature.

The Directouch 2000 offered both in a hardware/software package or installed in a variety of Nelson-Harkins kiosks provides a finished look: the option is yours. With unlimited name capacity and our Direct Access management software, information and updates are a finger's touch away.



Management
Screen



Main Screen



Main Screen Bulletin
Board Activated



Data Update



Company Screen



Company Listings



Company-Employee
Listings Activated



Individual Screen



Individual Listings

Data Management

- Complete with Direct Access data management program
- Easy-to-use icon menu access a variety of options system analysis
- Easy changes to company or individual listings
- Enter new information, click icon system is updated
- New entry inserts automatically in correct alphabetic position
- Remote updating may occur via network, modem, or diskette

Hardware

- Highest quality hardware
- Innovative software
- Windows-based computer
- Host storage system delivers unmatched speed
- Standard high-resolution 15" touch screen monitor options
- Installation in almost any mounting condition
- 4" deep flat-screen through-glass monitor for special situations