

Standard Profiles

BR-111™ offers the following moldings and accessories to complete final 3/4" installation. Profiles are also available in 5/16" and 7/16" proportional dimensions.

Reducer Strip

Use at thresholds to connect hardwood floor to vinyl or low-pile carpet. Fasten down with adhesive.

Stair Nosing

Add a professional finished look to steps and stairways. Fasten down with adhesive and nails (must be pre-drilled to prevent splitting). Available to match 3" or 5 1/2" face size.

Shoe Molding

Covers the space between the wall and hardwood flooring. Must be pre-drilled and nailed to the vertical surface, not the floor.

Stair Tread

Bull nosed on one side, stair treads are milled from solid wood and provide the walking surface fastened to the staircase.

Stair Riser

Milled from solid wood, stair risers lift stair treads to the next step.

T-Mold

Provides a smooth transition between two different flooring surfaces, including hardwood to ceramic tile, marble, vinyl, or carpet.

Threshold Transition

Provides a smooth transition between hardwood and other flooring materials, terminating on one side.

Feature Strips

Accent strips are used as decorative borders to enhance hardwood flooring installations.

All moldings and accessories come in 88" lengths and are sold 5 pieces to a box.

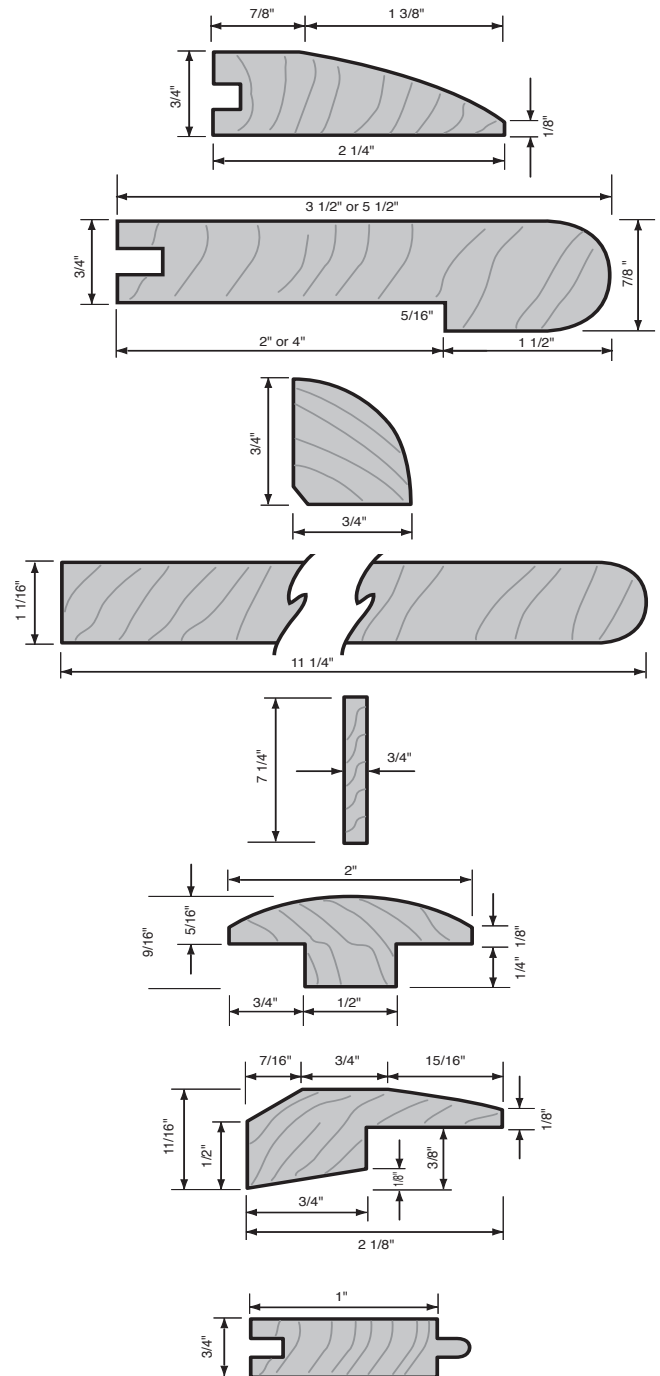

Standard Profiles

BR-111™ offers the following moldings and accessories to complete final 3/4" installation of Antiquity™ Hand-Scraped collection.

Reducer Strip

Use at thresholds to connect hardwood floor to vinyl or low-pile carpet. Fasten down with adhesive.

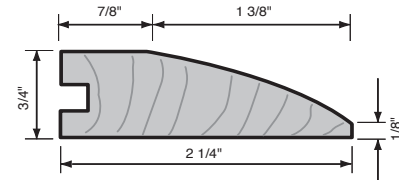

Stair Nosing

Add a professional finished look to steps and stairways. Fasten down with adhesive and nails (must be pre-drilled to prevent splitting).

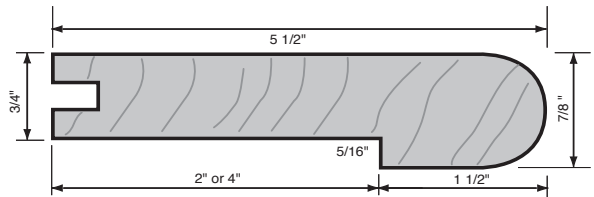

Shoe Molding

Covers the space between the wall and hardwood flooring. Must be pre-drilled and nailed to the vertical surface, not the floor.

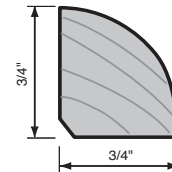

T-Mold

Provides a smooth transition between two different flooring surfaces, including hardwood to ceramic tile, marble, vinyl, or carpet.

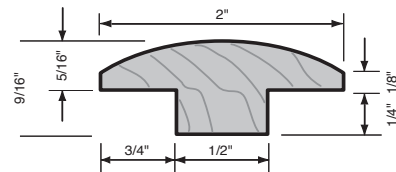

Threshold Transition

Provides a smooth transition between hardwood and other flooring materials, terminating on one side.

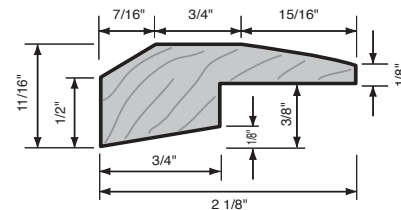

All moldings and accessories come in 88" lengths and are sold 5 pieces to a box.

Standard Profiles

BR-111™ offers the following moldings and accessories to complete final 7/16" installation. Profiles are also available in 3/4" and 5/16" proportional dimensions.

Reducer Strip

Use at thresholds to connect hardwood floor to vinyl or low-pile carpet. Fasten down with adhesive.

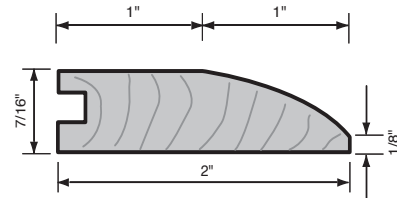

Stair Nosing

Add a professional finished look to steps and stairways. Fasten down with adhesive and nails (must be pre-drilled to prevent splitting).

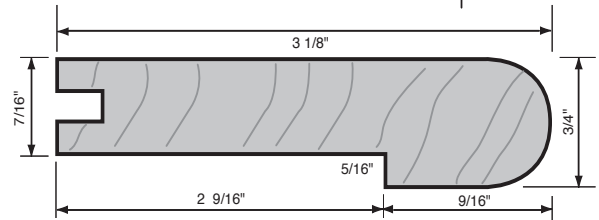

Shoe Molding

Covers the space between the wall and hardwood flooring. Must be pre-drilled and nailed to the vertical surface, not the floor.

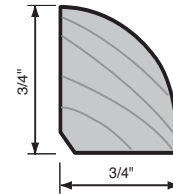

Stair Tread

Bull nosed on one side, stair treads are milled from solid wood and provide the walking surface fastened to the staircase.

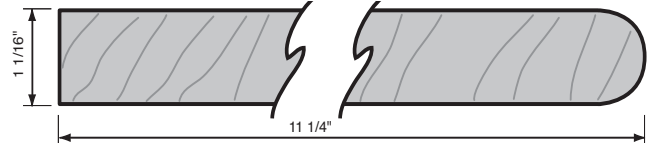

Stair Riser

Milled from solid wood, stair risers lift stair treads to the next step.

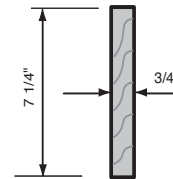

T-Mold

Provides a smooth transition between two different flooring surfaces, including hardwood to ceramic tile, marble, vinyl, or carpet.

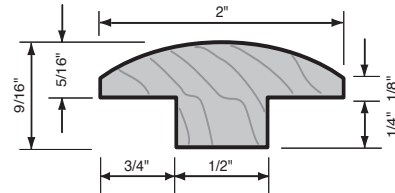

Threshold Transition

Provides a smooth transition between hardwood and other flooring materials, terminating on one side.

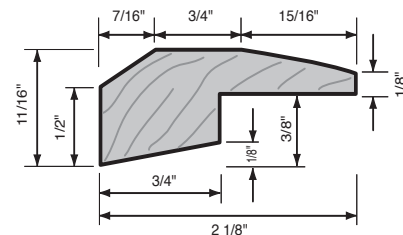

All moldings and accessories come in 88" lengths and are sold 5 pieces to a box.

Standard Profiles

BR-111™ offers the following moldings and accessories to complete your Indusparquet® 5/16" Solid or BR-111™ Engineered installation. Profiles are also available in 3/4" and 7/16" proportional dimensions.

Reducer Strip*

Use at thresholds to connect hardwood floor to vinyl or low-pile carpet. Fasten down with adhesive.

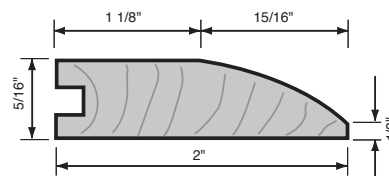

Stair Nosing*

Add a professional finished look to steps and stairways. Fasten down with adhesive and nails (must be pre-drilled to prevent splitting).

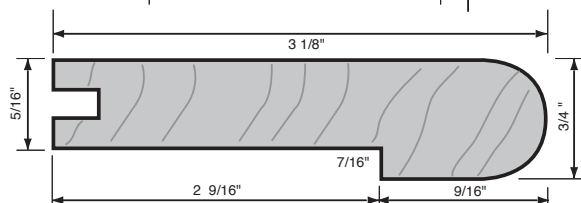

Shoe Molding

Covers the space between the wall and hardwood flooring. Must be pre-drilled and nailed to the vertical surface, not the floor.

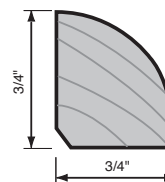

Stair Tread

Bull nosed on one side, stair treads are milled from solid wood and provide the walking surface fastened to the staircase.

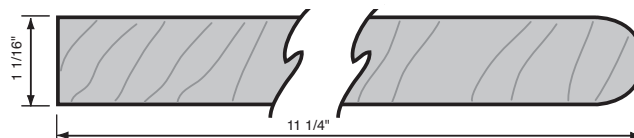

Stair Riser

Milled from solid wood, stair risers lift stair treads to the next step.

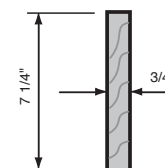

T-Mold

Provides a smooth transition between two different flooring surfaces, including hardwood to ceramic tile, marble, vinyl, or carpet.

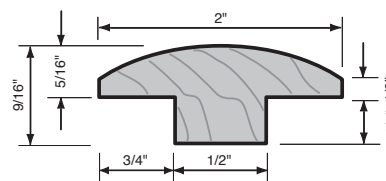

Threshold Transition

Provides a smooth transition between hardwood and other flooring materials, terminating on one side.

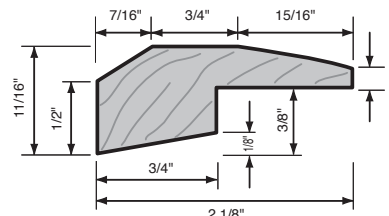

All moldings and accessories come in 88" lengths and are sold 5 pieces to a box.

Standard Profiles

BR-111™ offers the following moldings and accessories to complete your Dolomites Engineered or Triângulo® Engineered installation. Profiles are also available in 3/4", 5/16", and 7/16" proportional dimensions.

Reducer Strip

Use at thresholds to connect hardwood floor to vinyl or low-pile carpet. Fasten down with adhesive.

Stair Nosing

Add a professional finished look to steps and stairways. Fasten down with adhesive and nails (must be pre-drilled to prevent splitting).

Shoe Molding

Covers the space between the wall and hardwood flooring. Must be pre-drilled and nailed to the vertical surface, not the floor.

Stair Tread

(Not available for Dolomites products) Bull nosed on one side, stair treads are milled from solid wood and provide the walking surface fastened to the staircase.

Stair Riser (Not available for Dolomites products)

Milled from solid wood, stair risers lift stair treads to the next step.

T-Mold

Provides a smooth transition between two different flooring surfaces, including hardwood to ceramic tile, marble, vinyl, or carpet.

Threshold Transition

Provides a smooth transition between hardwood and other flooring materials, terminating on one side.

All moldings and accessories come in 88" lengths and are sold 5 pieces to a box.

