

Coat Racks
Floor Racks
Hooks
Hangers
Hook Panels
Concealed Wardrobes

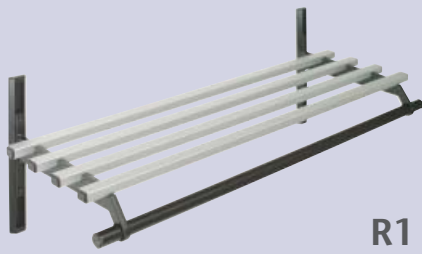

Aluminum and Hardwood Coat Racks



R1



R2



HCR



U Utility Shelf

Whenever large groups gather at convention centers, hotel meeting rooms and other public assembly facilities, they need the rugged practicality of EMCO's coat and hat rack systems. These convenient storage units require limited space and stand up under heaviest use.

- Easy-to-install sturdy aluminum wallstrip and brackets in Satin Black
- Concealed fasteners anchor hanger bars to brackets
- Convenient coat hooks securely fastened in extruded aluminum satin (silver) or bronze slats
- Custom lengths from 2' to 50'
- Hanger bar features an extremely durable, scratch-resistant powder coat finish in Black
- Space efficient, non-obtrusive design

R1 SYSTEM

Shown in Satin (Silver)

This basic hanger system is perfect for hotels, restaurants, churches and schools. It is easy to install and built to last. The slat options are satin (silver) and bronze extruded aluminum as well as the American hardwood selection of light or medium oak and walnut finish.

R2 SYSTEM

Shown in Light Oak

Double shelf unit is the right choice in those situations where additional storage is needed.

HCR HINGED SYSTEM

Shown in Medium Oak

EMCO's unique hinged coat rack system makes compliance with the use and access specifications of the American Disability Act (ADA) simple and economical. When not in use, the HCR model conveniently retracts out of the way.

U UTILITY SHELF SYSTEM

Shown in Satin (Silver)

This utility shelf solves your need for additional storage above an existing shelf or in a storage room by itself. Perfect for lower grade classrooms at just above floor level for storage of boots and other items.

HARDWOOD SELECTIONS



Light Oak



Medium Oak



Walnut

"R" HANGER SYSTEM

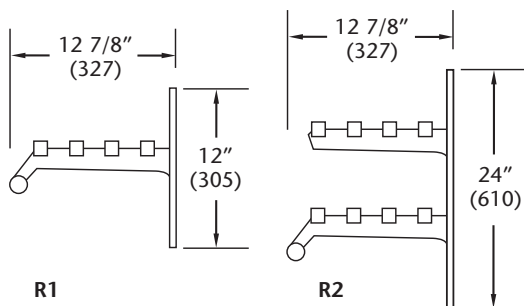

"U" SYSTEM

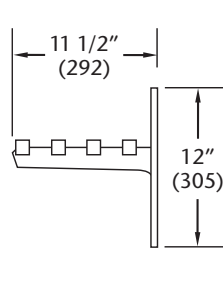

"HCR" SYSTEM

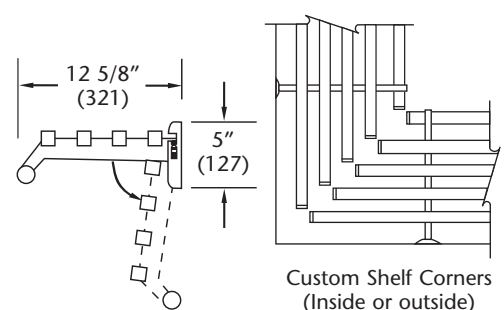

Coat Racks, Hooks & Hangers

10 57 13 / EMC
BuyLine 8538

H1 SYSTEM

Shown in Bronze

Maximum capacity with a minimum of space. Molded double-pronged polycarbonate hooks come in Red, Yellow, Dark Brown, Gray, Green, Blue, Purple, Orange or Black.

H2 SYSTEM

Shown in Satin (Silver)

The perfect solution for those situations where additional storage is needed with the hook system.

W HOOK STRIP SYSTEM

Shown in Satin (Silver)

Ideal complement under any shelf system. May also be used by itself. Comes with molded double-pronged polycarbonate hooks in the same colors as the H1 system.



T1 SYSTEM

Shown in Satin (Silver)

Crush-free coat storage system which includes four No. 10 ball top hangers and locked-in-place receptacles per foot of shelf.

10HK HOOK COLOR CHOICES

The 10HK color hook system is perfect for schools and other organizations that strongly identify with colors.

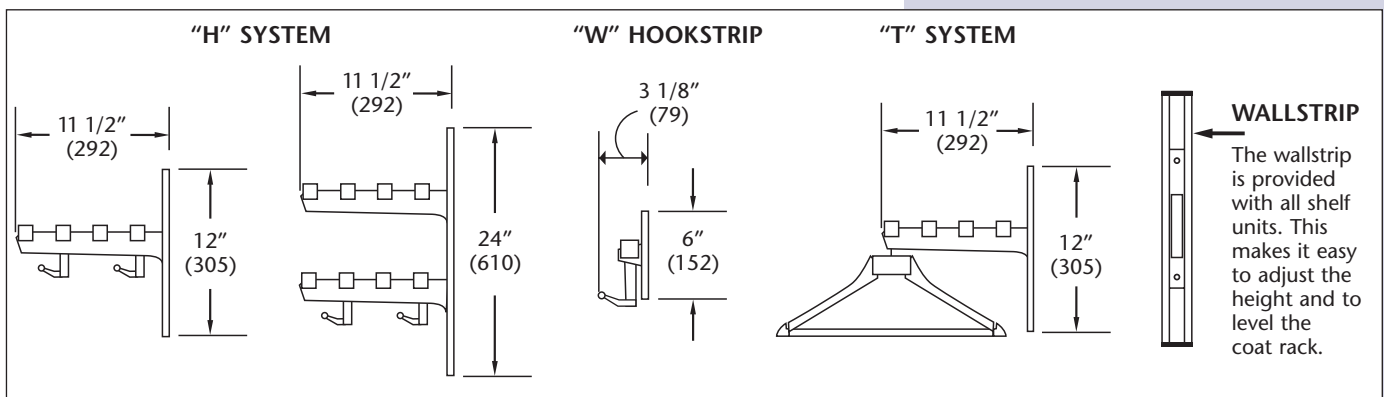
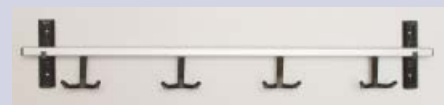
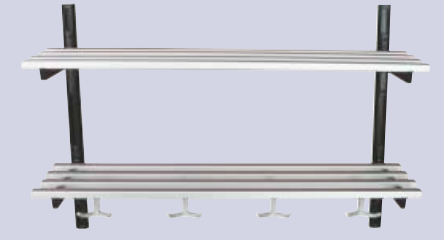

Hooks, Hangers and Hook Panels

HOOK COLLECTIONS

EMCO's selection of hat and coat hooks are sure to satisfy your decorating needs. Our hooks are available in aluminum, steel and nylon construction. The many color choices give you the ability to add some spice to your work area. If you prefer, we can mount these hooks directly to oak or walnut panels, which feature soft radius edges, and come with a concealed wall fastener plate. They will accommodate two, three, four or six hook sizes.

HOOK DIMENSIONS

Model	Material	Height	Width	Projection	Colors
A10	Aluminum	5-1/4"	1-3/8"	4-1/4"	Gold, Silver, Brass Plated
A11	Aluminum	5-3/8"	2-5/8"	3-3/8"	Gold, Silver
A19	Aluminum	6-3/8"	3/4"	3-3/8"	Silver
D10	Aluminum	2-3/4"	3/4"	2-3/8"	Almond, Antique Brass, Black, Dark Brown, Silver
L1	Aluminum	2"	1-3/8"	2-5/8"	Silver
L2	Aluminum	2"	3"	2-1/2"	Silver
M10	Aluminum	5-1/4"	2-3/16"	3-1/8"	Chrome, Brown, Black, Red, Yellow
N1	Nylon	7"	15/16"	4"	Black, Yellow
P1	Aluminum	1-5/8"	1-5/8"	2-1/2"	Black, Silver
S10	Steel	5-5/8"	3/4"	3-3/8"	Black
Y10	Aluminum	2-15/16"	3/4"	3"	Black, Silver

HOOK PANELS

	Number of Hooks	"A" Panel Depth	"B" Panel Height	"C" Panel Length
2 Hook Panel	2	5/8"	3 3/4"	6"
3 Hook Panel	3	5/8"	3 3/4"	12"
4 & 6 Hook Panel	4 & 6	5/8"	3 3/4"	24"

Hook panels are available in Light Oak, Medium Oak or Walnut solid wood panels, with 2, 3, 4 & 6 hooks per panel. They may be ordered with your choice of hooks and knobs installed.

(All panels are shipped completely assembled)

Contact Us for Custom Length Hook Panels



13K HOOK SYSTEM

Shown in Light Oak

Attractive panel with A-17 pegs. Perfect wherever space is limited with the need for temporary storage of coats/hats. Has radiused edges and concealed mounting.

HD10 HOOK SYSTEM

Shown in Medium Oak

High quality finish panel board with stylish hook, convenient for hanging on the wall or behind office door. The precision design of double hooks gives added storage in limited space. Choose from 2, 3, 4 and 6 hook panels.

13C2

Shown in Walnut

Convenient storage for restricted space. Handsome enough for the executive office. Fitting compactly behind the door. Has radiused edges, hidden fasteners plus luxury finishes with matching hangers.

13P1

Shown in Medium Oak

Versatile hanging unit for coats and hats gives users choice of hanger or rounded P1 hooks. Comes with attractive finish and matching hanger.

13P2

Shown in Light Oak

This executive customer is the same style as the 13P1, but comes with two matching wood hangers.

GHP

Shown in Medium Oak

Great for the hospitality industry. This hard wood hook panel utilizes the P1 hook for holding the guests garment bag.

13U6 HOOK STRIP

Nickel plated steel hooks on a brushed metal panel. Great for tight fitting spaces.

13U12 HOOK STRIP

Double storage capacity with the 12 hook panel.

13D10 HOOK SYSTEM

A simple, yet complete wall-mounted customer. A slotted hook below to receive a contemporary hanger with hat holder above. A number 11 ball top hanger is included.

13Y10 HOOK SYSTEM

Designed to accommodate two coats, this customer uses an aluminum double slotted Y10 hook which holds two number 11 ball top hangers.

Hook Board Dimensions

Model	Panel Height	Panel Projection	Panel Length	No. Of Hooks	Weight
2HD10	3-3/4"	3-1/8"	8"	2	1
3HD10	3-3/4"	3-1/8"	12"	3	1-3/4
4HD10	3-3/4"	3-1/8"	24"	4	2
6HD10	3-3/4"	3-1/8"	24"	6	3-1/4
13C2	5-5/8"	3-7/8"	17"	4	3
13D10		2-1/2"	17"		1
13K2	3-3/4"	3-7/8"	8"	2	1
13K3	3-3/4"	3-7/8"	12"	3	2
13K4	3-3/4"	3-7/8"	24"	4	2
13K6	3-3/4"	3-7/8"	24"	6	3
13P1	5-5/8"	3-1/4"	17"	3	3
13P2	5-5/8"	3-7/8"	17"	3	3
13U6	2-1/2"	1-3/4"	18"	6	2
13U12	2-1/2"	1-3/4"	39"	12	3
13Y10		3-1/4"	17"		1
GHP	5-5/8"	3-1/8"	6"	1	2

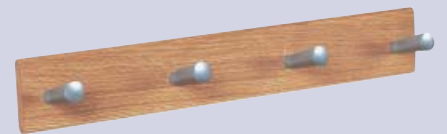

13K HOOK SYSTEM



HD10 HOOK SYSTEM



13C2



13P1



13P2



GHP



13U6 HOOK STRIP



13U12 HOOK STRIP



13D10 HOOK SYSTEM



13Y10 HOOK SYSTEM

Portable Coat Racks & Floor Racks



20-3 System



22-4 System

20-4 System



Model shown includes optional boot rack.



#72 Portahanger System



#80 Portahook System

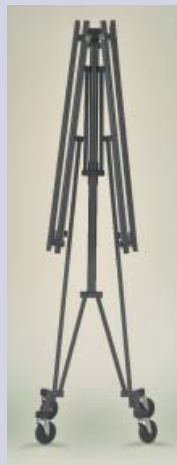

Portable Coat Racks

FLOOR RACKS

Rigid construction, clean design and low cost are combined in a basic floor rack. Convenient for hallway or receiving area in office building. Choose single or double sided styles in 3' or 4' lengths in Almond or Black. Hangers are included. Boot rack and casters options are available.

20-3 SYSTEM

Shown in Black

This 36" unit comes with 12 open hook hangers.

22-4 SYSTEM

Shown in Black

This double sided 48" unit comes with 32 open hook hangers.

20-4 SYSTEM

Shown in Almond

This 48" floor rack includes 16 open hook hangers.

22-3 SYSTEM (NOT SHOWN)

This double sided 36" unit comes with 24 open hook hangers.

PORTABLE COAT RACKS

These versatile portable coat racks can be used as temporary checkrooms in a variety of settings including hotels, schools, churches, convention centers and galleries. The racks fold in a snap to 21" x 81" and move through ordinary doorways or narrow corridors. Fully extended, all units are 72" L, 63" H, 27" D. All frames are Black with 3" casters. Choice of satin (silver) or Bronze shelves.

#72 PORTAHANGER SYSTEM

Shown with Satin (Silver) Slats

Completely assembled at factory, this hanger model has a 72-coat capacity with a single shelf. Hangers not included.

#80 PORTAHOOK SYSTEM

Shown with Bronze Slats

Forty double-pronged polycarbonate hooks are virtually indestructible and lock inside radiused aluminum shelves. 40 hooks provided accommodate 80 coats.

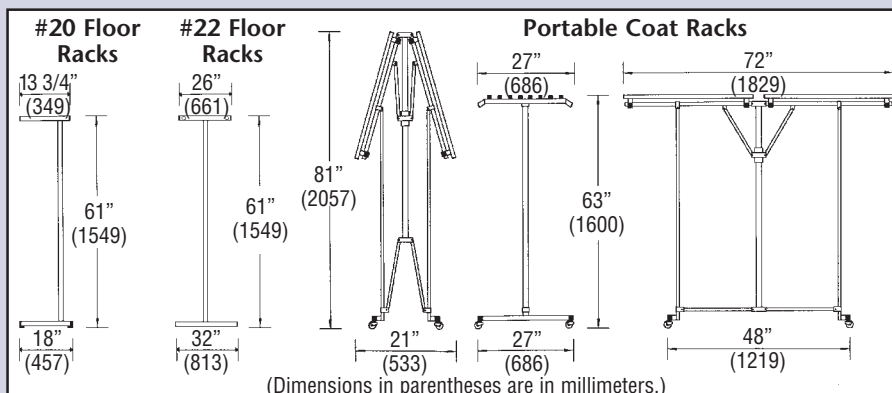

CLASSROOM WARDROBES

EMCO's Classroom Wardrobes are specifically designed to meet the unique needs of students and teachers in the classroom.

- Tackable front panel surface (available in a variety of colors)
- Variable shelf heights for students of varying ages/heights
- Convenient boot shelf and hat shelf, and an additional storage shelf with hooks (strong enough for back packs)
- Durable, scratch-resistant powder coat finish
- Easy to install, maintenance-free
- Space efficient, non-obtrusive design

15H8 CLASSROOM WARDROBE – CORNER UNIT

Single student unit, or teacher supply closet. Designed with a hook shelf which is adjustable to various heights.

15H16 CLASSROOM WARDROBE

Double student unit contains hooks and shelf space to accommodate coats, books, and supplies for 16 students. The hook-shelves are adjustable for students' easy access.

15H8 Classroom Wardrobe – Corner



15H16 Classroom Wardrobe

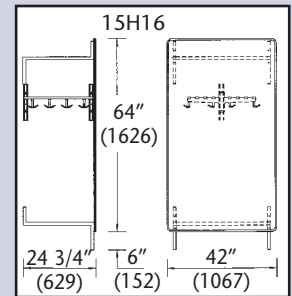
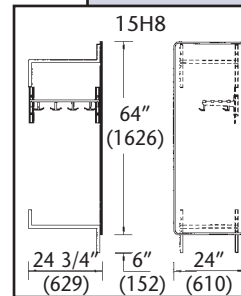

CONCEALED WARDROBES

Our line of Concealed Wardrobes are ideal for virtually any building where there is the need for convenient storage of coats, umbrellas and other personal belongings.

- Choice of Light Oak, Medium Oak or Walnut laminate for front panel as well as white
- Durable, scratch-resistant powder coat finish
- Easy to install, maintenance-free
- Space efficient, non-obtrusive design

13R4 CONCEALED WARDROBE

Cantilevered simple elegance. The chamfered-edged panel secures to lower die cast aluminum brackets. The lower shelf is ideal for briefcase or boots. Four contemporary hangers are spaced on the hanger bar which has its own bracket for panel and wall attachment. Two separate hat hooks are mounted to the panel interior.

13R4L CONCEALED WARDROBE

To-the-floor legs give additional support which is desirable when walls are not capable of handling extra weight. Four hangers plus full shelf, top and bottom, provide added storage.



A-13R4 Concealed Wardrobe



B-13R4L Concealed Wardrobe

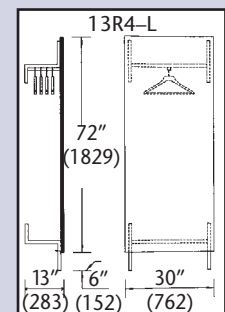
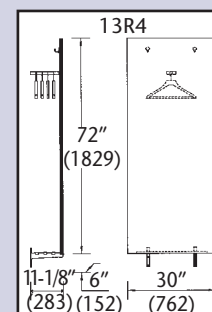

Hangers & Receptacles



3 hook styles to choose from! (see chart)

MODEL NUMBER 10 – Dark Brown molded plastic hanger with a unique non-slip trouser bar. Available in conventional open hook and ball top for use with A, B or C receptacles.

MODEL NUMBER 11 – The texture of grained leather in a Black, molded contemporary hanger. The hook is heavy-gauge plated steel. Available in open hook, ball top for receptacles and theft-proof closed loop.

MODEL NUMBER 13 – Contemporary design in a choice of Walnut, Light Oak or Medium Oak finished hardwood. Furniture finish with plated hook in open or ball top style.

MODEL NUMBER 15 – Durable 17" hardwood hanger with lacquered finish. Plated hook in open, ball top or closed loop designs with pants bar. Available with or without skirt clip.

Hangers/Receptacles					
Model	Material	Color	Ball Top	Open Hook	Closed Loop
10	Plastic	Dk. Brown	x	x	
11	Plastic	Black	x	x	x
13	Hardwood	Lt. Oak	x	x	
		Md. Oak	x	x	
		Walnut	x	x	
15	Hardwood	Natural	x	x	x
	Hardwood W/SC	Natural	x	x	x
17	3/16" Wire	Chrome	x	x	x
A	Plastic	Dk. Brown			
B	Plastic	Black			
C	Steel	Nickel Plated			



Optional coat hook can be added to any of our R model shelves.

MODEL NUMBER 17 – Heavily plated hanger of 3/16" wire, shaped, and securely formed to take maximum abuse, available in open hook, ball top and closed loop.

MODEL NUMBER A – Receptacle - Can install over existing rods, then snaps closed permanently. Slides freely on rods up to 1-3/8" dia. Dark Brown finish.

MODEL NUMBER B – Receptacle - Fits 1" Hanger rod securely for fixed space. Molded, Black.

MODEL NUMBER C – Receptacle - Nickel-plated steel slides on hanger rods up to 1-3/8".



ORDERING INFORMATION

- All orders must be faxed or mailed. NO PHONE ORDERS ACCEPTED.
- Faxed orders being confirmed by mail must clearly state "CONFIRMATION" on the mailed order. EMCO cannot be held responsible for duplications when this information is omitted.
- No minimum order or minimum order charge.
- Always specify NAME and/or PRODUCT NUMBER, COLOR or FINISH, and LENGTH (when applicable).
- F.O.B. Kansas City, Kansas.
- Terms are net 30 days.
- For drop shipments, provide street address and zip code.
- No returns after 30 days. RGA required.
- All returns subject to a 25% restocking charge. Large and custom length orders are not returnable.
- All units are shipped K.D. except hook panels and portaracks.
- All units ship UPS except large quantities, portaracks, semi-concealed wardrobes and shelves over 8 ft. in length. These items ship common carrier class 70.
- Custom lengths available on all wall hung coat racks and shelves.
- All wood shelves over 8 ft. are spliced.
- All aluminum shelves over 12 ft. are spliced.
- Standard quantity of hangers per foot of coat rack is four.
- Shop drawings available upon request with purchase order.
- Color charts or slat/hanger rod samples available upon request.
- For wall to wall shelves, subtract 1" from the total width when ordering unit.

SPECIFICATIONS

COAT RACKS

PART 1 - GENERAL

- DESCRIPTION: Furnish and install wall mounted coat rack.
- RELATED WORK: (Refer to Section of Specs which applies to wall blocking for coat racks.)

PART 2 - PRODUCTS

- MANUFACTURER: EMCO (specify H1, H2, HCR, R1, R2, T1, Hook Strip or Utility Shelf) unit by EMCO Specialty Products, Inc., Kansas City, KS.
- MATERIALS:
 - Wall strips are 1/2" extruded aluminum powder coated black.
 - Brackets are solid cast aluminum powder coated black. Bracket screws are included to allow for height adjustment.
 - Shelf slat is extruded aluminum (specify finish) or (specify walnut, light or medium oak) hardwood slat.
 - (H1, H2, Hook Strip Series) shall include double-pronged polycarbonate 10HK hook locked in place in second and fourth slat. The number and arrangement as per manufacturer's standards. Hook color to be (specify red, yellow, dark brown, gray or black.)
 - (R1, R2 Series) Hanger bar shall be 1" black aluminum tube capped at each end.
 - Accessories: EMCO hanger No. (specify hanger and receptacles) shall be spaced 4 per foot.

PART 3 - EXECUTION

INSTALLATION:

- Install wall blocking
- Install wall strip and level.
- Install brackets using EMCO fasteners.
- Install slat using EMCO fasteners.
- Remove all trash and debris.

HOOKS AND HOOK PANELS

PART 1 - GENERAL

- DESCRIPTION: furnish and install wall mounted (specify hooks or hook panels).
- RELATED WORK: (Refer to Section of Specs which applies to wall blocking.)

PART 2 - PRODUCTS

- MANUFACTURER: EMCO (HD10, 13K, 13C2, 13P1) series hook panel by EMCO Specialty Products, Inc. Kansas City, KS.
- MATERIALS: Panel shall be of solid (walnut or oak) hardwood and drilled for (number of hooks). The finish is to be (walnut, medium or light oak).
- ACCESSORIES: EMCO hook no. (specify hook number) in (specify color).

PART 3 - EXECUTION

INSTALLATION:

- Install panel mounting plate to wall.
- Check to make sure it is level.
- Remove adhesive backing strip from back of panel.
- Slide panel plate over mounting plate.
- Remove all trash and debris.

EMCO

Specialty Products, Inc.

408 Miami Ave., Kansas City, KS 66105
 Phone: 913-281-4555 Fax: 913-281-4554
 Website: www.emcospi.com

Manufacturer reserves the right to modify design, change programs, prices or specifications at any time.