

BIRD JOLT™

Flat Track

Installation Instructions



**For Technical Assistance Call
1-800-392-6915**



BIRD•B•GONE INC.

BIRD JOLT FLAT TRACK **INSTALLATION INSTRUCTIONS**

CAUTION – READ BEFORE STARTING INSTALLATION!

Bird-B-Gone's Bird Jolt FlatTrack is a low profile electric track system that is easy to install with some basic electrical knowledge. To be used on a flat surface in an open area where birds may be loafing. (Example: window ledges, parapet walls, open beams, etc.) As with all Bird-B-Gone products if you have any questions please call our technical support @ **1-800-392-6915**.

PRIOR TO INSTALLATION:

1. Determine the width of area to be covered to calculate number of rows required.
2. Determine type of charger to be used (Direct Wire or Solar).
 - a. Tape Measure
 - b. Pencil or Pen
 - c. Utility Knife
 - d. Scissors
 - e. Voltage Tester
 - f. Crimping Tool
 - g. Pliers
 - h. Wire Cutter/ Stripping Tool
 - i. Polyurethane Construction Adhesive & Caulking Gun

◆ **Be sure to use a polyurethane adhesive to secure FlatTrack to the mounting surface. Approximately 1 tube per 25 feet of track.**

Be sure to allow glue to cure thoroughly during installation. Glue must be completely dry (cured) before the system will be effective.

DO NOT INSTALL BIRD JOLT FLAT TRACK WHERE IT MAY COME INTO CONTACT WITH PEOPLE.

WARNING: Electric track systems should not be used if contact with flammable liquids, vapors, or fumes is possible. Electric track systems should never be used in and around gas stations.



BIRD•B•GONE INC.

BIRD JOLT FLAT TRACK INSTALLATION INSTRUCTIONS

Step 1 Selecting a Charger:



Solar Charger CHG-SLR740 covers up to 300 linear feet of track and lead wire. (when using solar charger make sure there is southern exposure.)



Direct Charger CHG-AC750 covers up to 500 linear feet of track and lead wire. (Must be protected from the elements placed in a Bird-B-Gone waterproof box model CHG-ACBOX.)



Super Charger Direct CHG-ACBFC covers up to 2000 linear feet of track and lead wire. (Direct Charger must be enclosed in a waterproof box.)

Be sure to install **Bilingual Warning Labels** every 10 feet and near charging units

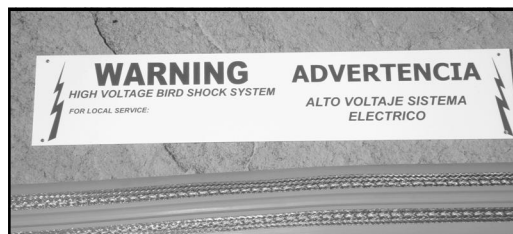

BIRD•B•GONE INC.

BIRD JOLT FLAT TRACK INSTALLATION INSTRUCTIONS

Step 2 Preparing Surface for Installation:



Remove all loose debris and bird droppings. Surface should be thoroughly cleaned and disinfected using Bird-B-Gone's Disinfectant **DIS-SQ8**.

Step 3 : Determine Number of Rows:

For Single Side Ledges/ Surfaces (i.e. ledges that have a back wall, window, etc.):

1" - 4" Use 1 Row of Bird Jolt Flat Track

5" - 8" Use 2 Rows of Bird Jolt Flat Track

9" - 12" Use 3 Rows of Bird Jolt Flat Track

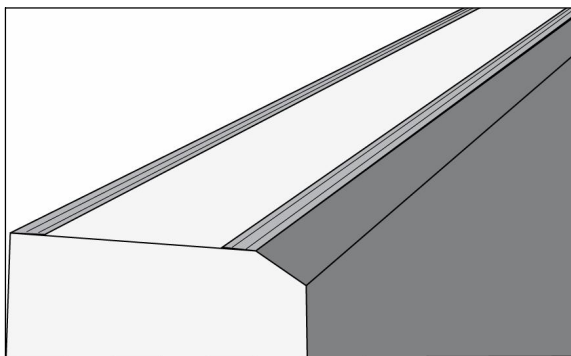
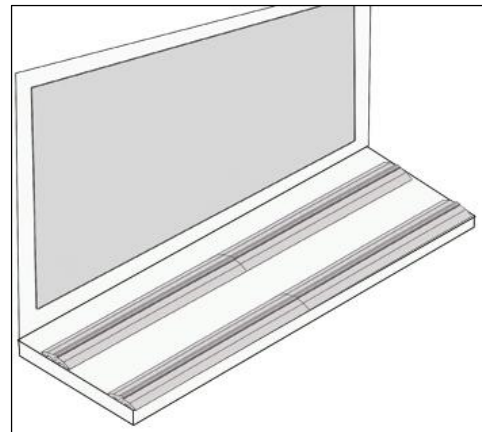

For Double Sided Ledges/ Surfaces (i.e. parapet walls, etc.), you will need to run a row on each side of the surface, as close to the edges as possible. Use the following chart for the number of rows:

1" - 6" Use 1 Row of FlatTrack on Each Side.

7" - 15" Use 2 Rows of FlatTrack on Each Side.

16" - 28" Use 3 Rows of FlatTrack on Each Side.



BIRD•B•GONE INC.

BIRD JOLT FLAT TRACK **INSTALLATION INSTRUCTIONS**

Step 4 Attaching FlatTrack Mounting Clips (for areas where water damming is an issue):

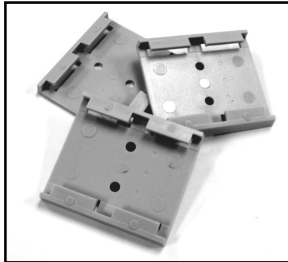

Mounting Clips

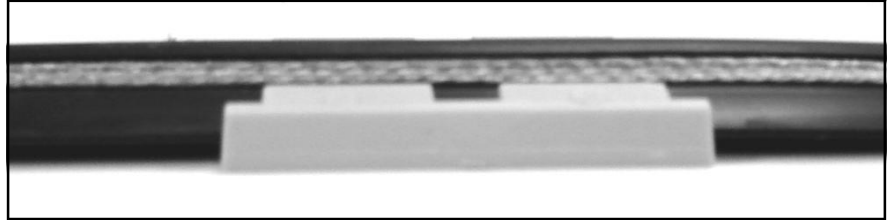

Keep Water from Damming.

- ◆ **Be sure to use a polyurethane adhesive to secure FlatTrack to the mounting surface. Approximately 1 tube per 25 feet of track.**

Be sure to allow glue to cure thoroughly during installation. Glue must be completely dry (cured) before the system will be effective.

Screw or glue mounting clips every three to five feet on mounting surface. Place a dab of adhesive to top of clip and insert track.

Step 5 Installation of Bird Jolt FlatTrack:

Bird-B-Gone Bird Jolt FlatTrack comes in 100 ft. kits in a ready to dispense box. Just pull the track out as you go along. Adhesive must be applied to the entire underside of the track for a secure bond.

Attaching Connectors:

1. Attach the “**Snug-Fit**” Connector base to the end of the Bird Jolt FlatTrack, insert end of next section of track to other side of base.

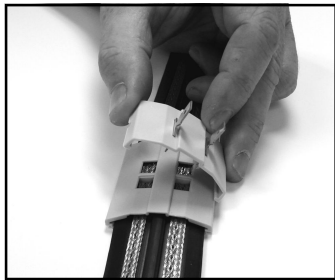

Easy Snap on “**Snug-Fit**” Connectors

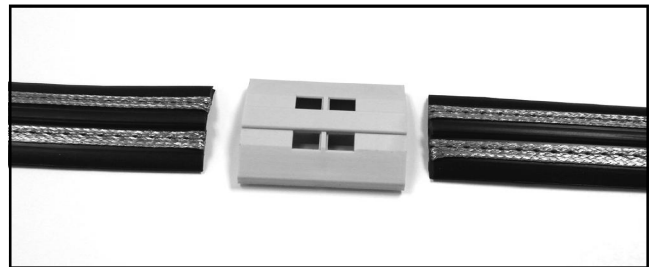

2. Snap top of “**Snug-Fit**” Connector base in place (apply pressure to insure full contact of pins) Use a dollop of adhesive on outside of seal to secure.
3. Apply Adhesive under connection and under rest of Bird Jolt FlatTrack.



BIRD•B•GONE INC.

BIRD JOLT FLAT TRACK INSTALLATION INSTRUCTIONS

Attaching T-Connections:

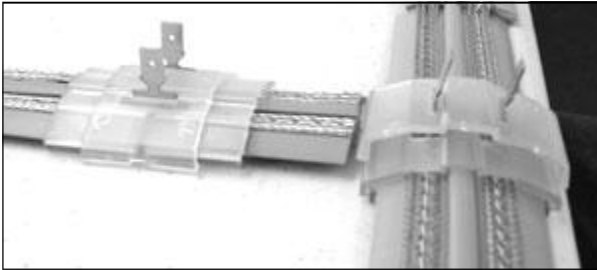

1. Cut a 3-4" section of track and attach "Snug-Fit" Connector as in Step 5 "Attaching Connectors".

2. Using lead in wire, attach FlatTrack power connector to all four wires.

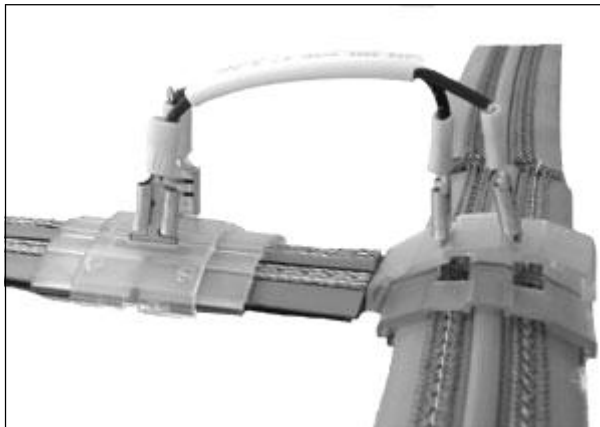
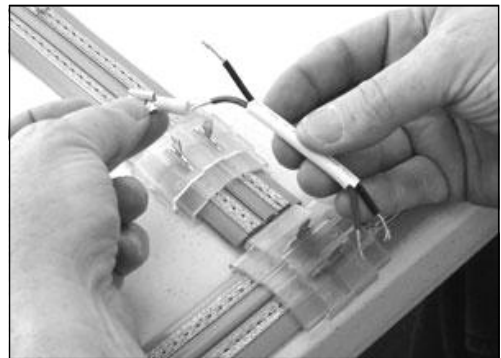
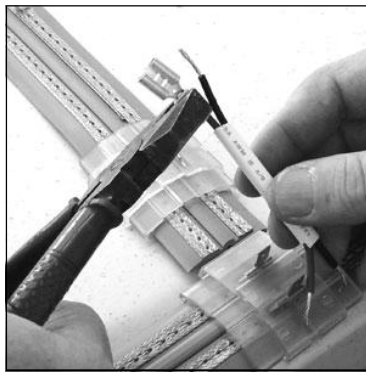

3. Slide power connectors over tabs of "Snug Fit" connector.



BIRD•B•GONE INC.

BIRD JOLT FLAT TRACK INSTALLATION INSTRUCTIONS

Attaching Corner Connections:

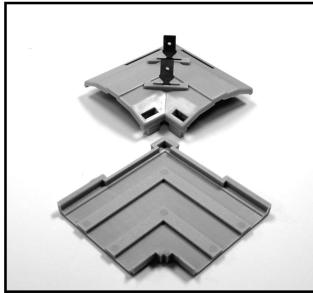

“Snug-Fit” Corner Connectors
BJFT-SFCC

1. Determine where your corner is and cut track at a 45 Deg. Angle as pictured below.

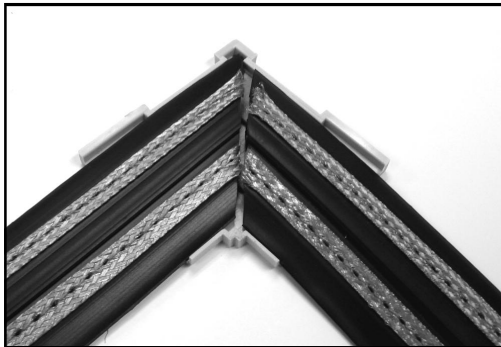
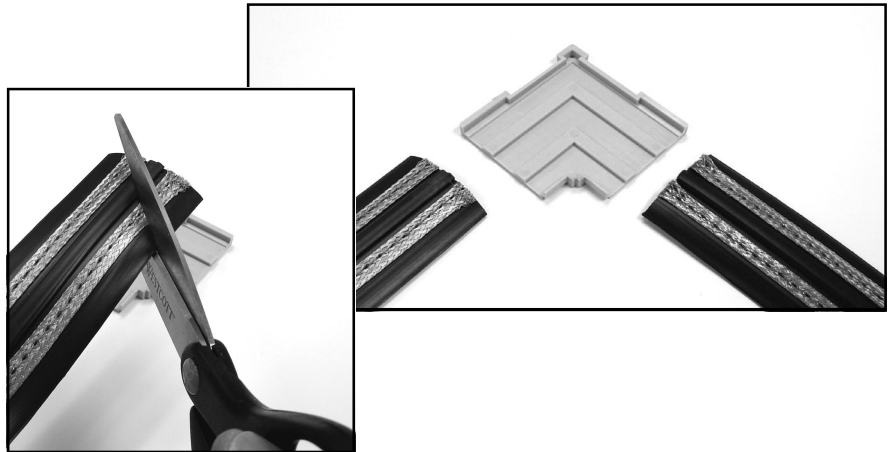

2. Place both pieces of track in bottom portion of “Snug-Fit” Corner Connector.

3. Secure top portion of Corner Connector over track and bottom half of connector, be sure it snaps in place. Use a dollop of adhesive on outside of seal to secure.
4. Secure corner connector to surface with adhesive.

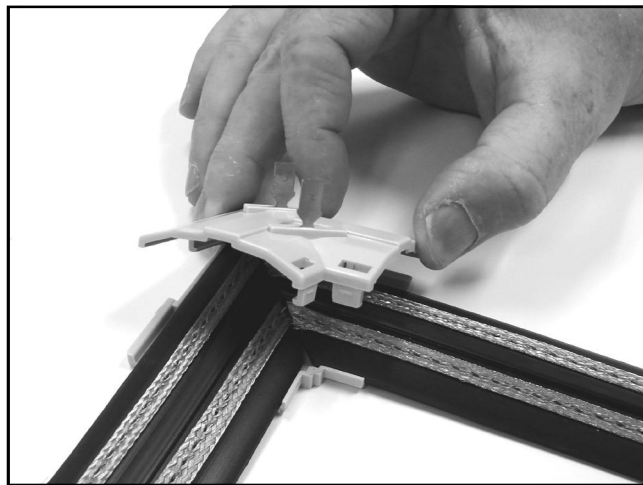

BIRD•B•GONE INC.

BIRD JOLT FLAT TRACK INSTALLATION INSTRUCTIONS

Step 6a Attaching FlatTrack to Charging Unit: Attaching Wire Directly from Track to Charger.

Be sure to allow glue to cure thoroughly during installation. Glue must be completely dry (cured) before the system will be effective.

- Attach power connectors to one end of lead in wire.
- Attach yellow power connectors to other ends of lead in wire.
- Using utility knife cut away approximately 3/4" of stitching from
- Slide yellow connector over braids and glue down to each track (to keep wires from touching)

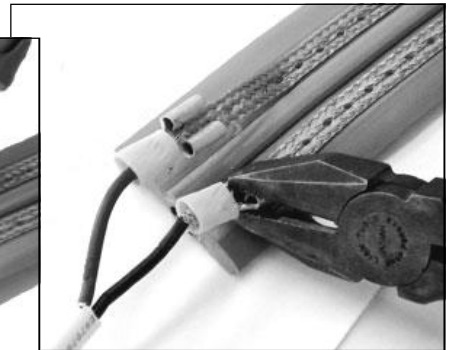
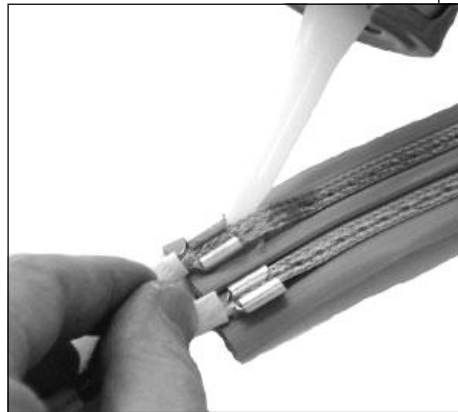

- Test Charging Unit with voltage meter
- Attach power loops to charging unit
- Test track connectivity with voltage meter



Direct Charger is to be housed in a NEMA Type 4 or 3 weatherproof enclosure. **CHG-ACBOX**

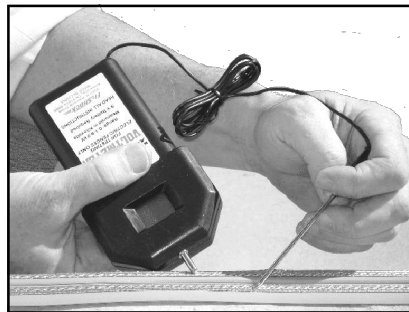

BIRD•B•GONE INC.

BIRD JOLT FLAT TRACK INSTALLATION INSTRUCTIONS

Step 6b Attaching FlatTrack to Charging Unit:

Attaching Wire from Snug Fit Connector to Charger.

- Attach yellow power connectors to end of lead wire.
- Attach a “Snug-Fit” Connector to track closest to charger.
- Slide yellow power connector over power tabs on snug fit connectors.
- Crimp to secure.

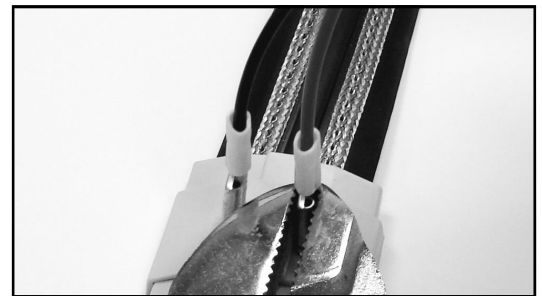

Direct Charger is to be housed in a NEMA Type 4 or 3 weatherproof enclosure. **CHG-ACBOX**

- Test Charging Unit with voltage meter
- Attach power loops to charging unit
- Test track connectivity with voltage meter

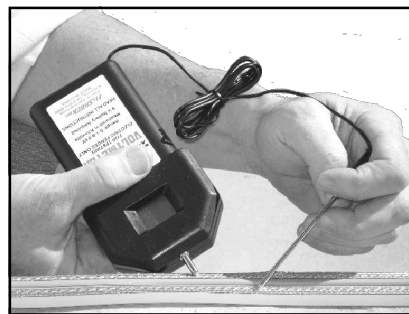

BIRD•B•GONE^{INC.}

BIRD JOLT FLAT TRACK INSTALLATION INSTRUCTIONS

WARNING – TO ENSURE SYSTEM SAFETY AND INTEGRITY

Be sure to mount Warning Labels in areas where they are clearly visible to anyone who may come in contact with the FlatTrack Electric Track System.

Do not use more than one energizer (Solar or Direct Charge) on the same run of the FlatTrack system.

Be sure to provide your customer (plant managers, building maintenance personnel, general management, etc.) with DETAILED FlatTrack System Operation, Including:

Drawings/ Documentation on Location and Position of FlatTrack System.
System Operation Details, including how to disconnect/ reconnect if necessary.
Safety information and troubleshooting.

NEVER COME IN DIRECT CONTACT WITH THE FLATTRACK SYSTEM WHILE IT IS TURNED ON!

DO NOT TURN OFF SYSTEM ONCE INSTALLED, as that will facilitate birds landing again. Bird droppings could short circuit the system when the system power is reconnected.

WARNING: Electric track systems should not be used if contact with flammable liquids, vapors, or fumes is possible. Electric track systems should never be used in and around gas stations.



BIRD•B•GONE^{INC.}