

# Fencing Catalog

Phone: 1-888-289-3362  
FAX: 1-800-542-8488  
MasterHalco.com



# ABOUT MASTER HALCO



## Master Halco's Mission

MASTER HALCO is the master of security, innovation and style. As North America's leading manufacturer and wholesale distributor of perimeter security and fencing, we are the provider of choice for thousands of professional fence and security contractors and quality building material retailers. Since 1961, we have been the industry's premier fencing provider.

We offer a complete line of high quality fence systems in both traditional and unique styles. Our full line of products include vinyl, wood, ornamental, and chain-link fences and gates for residential, commercial, industrial, and high security applications.

For all your fencing needs, you can trust MASTER HALCO.

## Our Commitment

Since 1961, Master Halco has grown to become the largest manufacturer and distributor of fencing materials in North America, serving thousands of the best retailers and installers across the United States and Canada.

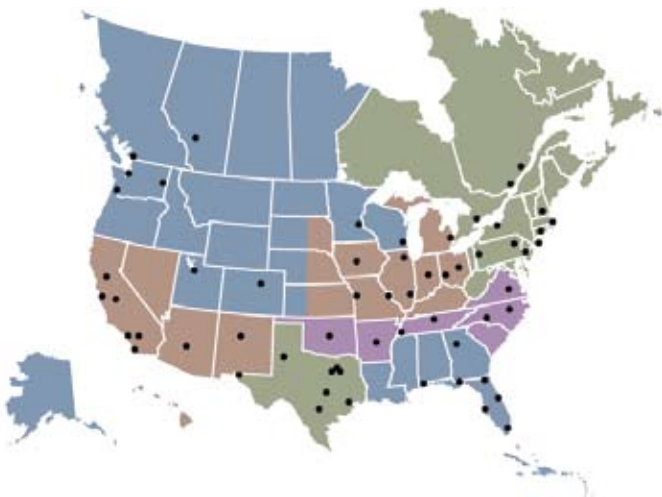

## Our Warranty

Our commitment to our products is also evident in our warranty programs. Visit our website to find out more.

MasterHalco.com.

For more information about Master Halco products, services, or warranties, call 1.888.289.3362 toll-free or visit us online: [MasterHalco.com](http://MasterHalco.com)

Master Halco operates from locations across North America with a vast network of distribution centers supported by our delivery fleet.



# TABLE OF CONTENTS

	<b>PAGE#</b>
Chain Link Case Pack Replenishment	<b>5-9</b>
Kennels	<b>10</b>
Line of Fence - Easy Order Chain-Link	<b>11-14</b>
Chain-Link Components & Fittings	<b>15-18</b>
Chain Link Gates	<b>19</b>
Color Chain-Link	<b>20-21</b>
Commercial Grade Chain-Link	<b>22-23</b>
Privacy Slats	<b>24</b>
Agricultural Fencing	<b>25</b>
Ornamental Aluminum Fencing	<b>26-31</b>
Ornamental Steel Fencing	<b>32-35</b>
Gate Hinge & Latch solutions	<b>36</b>
Ornamental Gates Custom	<b>37</b>
Vinyl Fencing	<b>38-39</b>
New Products	<b>40</b>
Welded Wire Fencing	<b>41</b>

Product assortment varies by location. Check with your branch for product availability



# EASY INSTALLATION GUIDE

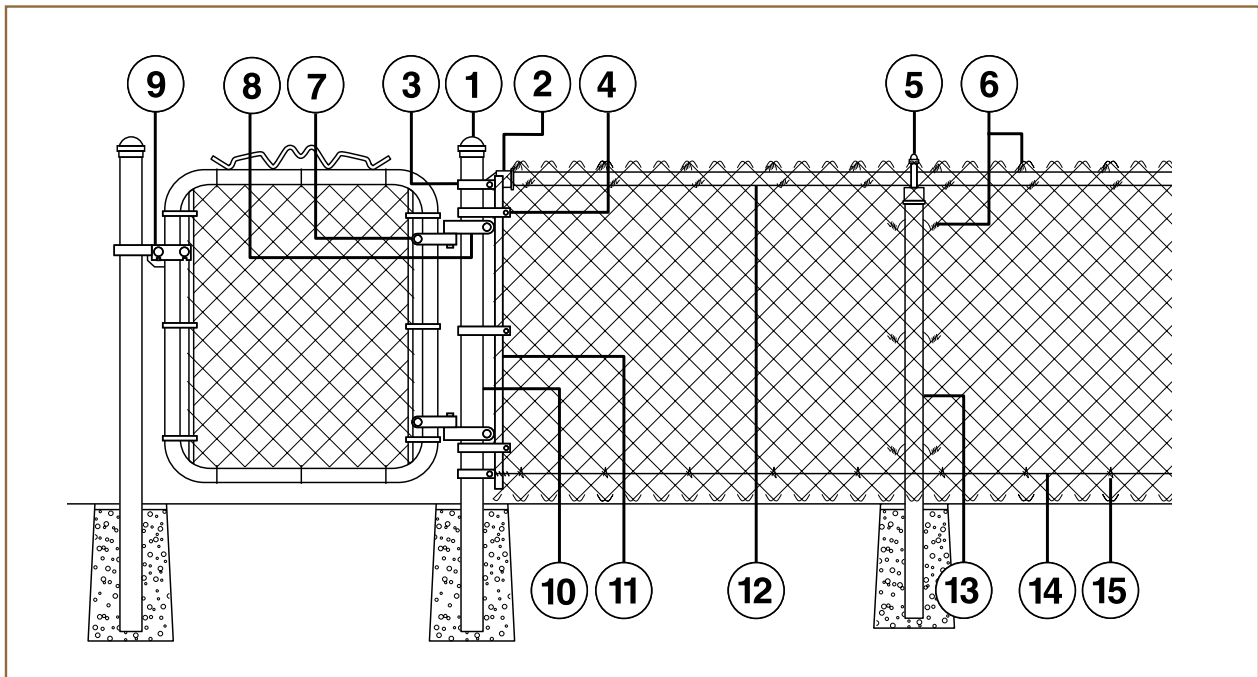

- ① Post Cap
- ② Rail End
- ③ Brace Band
- ④ Tension Band
- ⑤ Eye Top
- ⑥ Fence Tie
- ⑦ Gate Frame Hinge
- ⑧ Gate Post Hinge
- ⑨ Gate Fork Latch
- ⑩ Terminal Post
- ⑪ Tension Bar
- ⑫ Top Rail
- ⑬ Line Post
- ⑭ Bottom Tension Wire
- ⑮ Tension Wire Clip

### Terminal Post - End, Corner or Gate

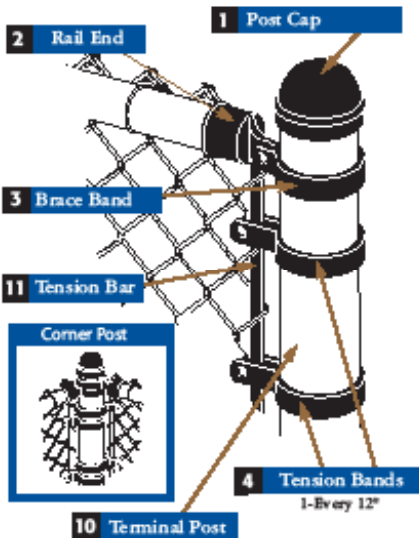

### Line Post & Top Rail

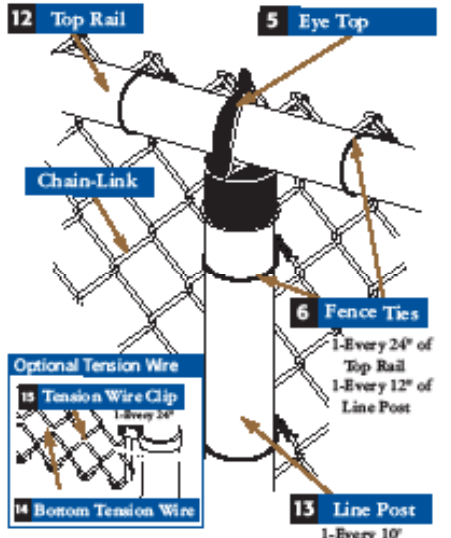

### Gate - Single Swing

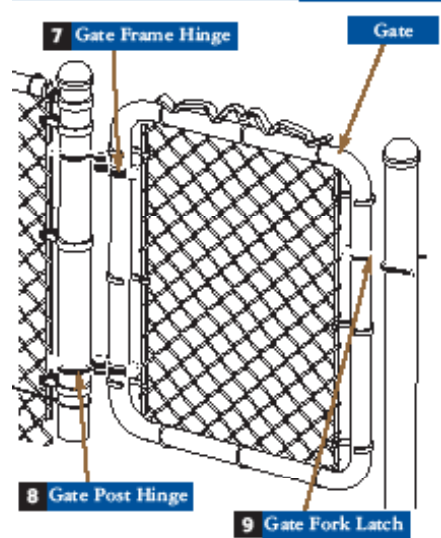

# CASE PACK - STOCK REPLENISHMENT

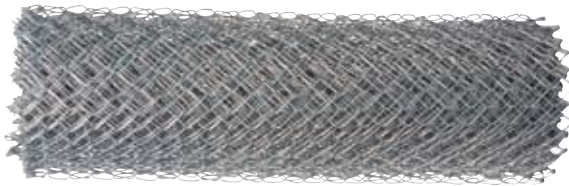

## 11-1/2 GAUGE x 2-3/8" MESH

DESCRIPTION	PART NO.
4' High - 48"X50' GBW KK <b>Full Size</b>	056265
5' High - 60"X50' GBW KK <b>Full Size</b> Roll	056266
6' High - 72"X50' GBW BK <b>Full Size</b> Roll	056267

**Case Pack - 9 Rolls Per Pallet** Available in other sizes and grades



## 12-1/2 GAUGE x 2-3/8" MESH

DESCRIPTION	PART NO.
4' High - 48"X50' GBW KK <b>Compressed</b> Roll	055499
5' High - 60"X50' GBW KK <b>Compressed</b> Roll	055810
6' High - 72"X50' GBW BK <b>Compressed</b> Roll	055811

**Case Pack - 20 Rolls Per Pallet**

## 10' Repair Roll 11-1/2 Ga 2-3/8 10'

DESCRIPTION	PART NO.
4' High - 48"X10' GBW KK Repair Roll	056256

**Case Pack - 16 Rolls Per Pallet**



## 18 GAUGE TOP RAIL

DESCRIPTION	PART NO.
1-3/8 x 10' 6" Swedge End 18 Gauge	030099
1-3/8 x 21' Swedge End 18 Gauge	030114

**Case Pack - 91 Per Bundle** Available in other sizes and grades

## 17 GAUGE TOP RAIL

DESCRIPTION	PART NO.
1-3/8 x 10' 6" Swedge End 17 Gauge	030007
1-3/8 x 21' Swedge End 17 Gauge	030102

**Case Pack - 91 Per Bundle**



## 18 GAUGE TERMINAL POST

DESCRIPTION	PART NO.
2-3/8" x 5' 6"	030822
2-3/8" x 6'	030823
2-3/8" x 8'	030827

**Case Pack - 37 Per Bundle**

## 17 GAUGE TERMINAL POST

DESCRIPTION	PART NO.
2-3/8" x 6'	030173
2-3/8" x 7'	030175
2-3/8" x 8'	030177

**Case Pack - 37 Per Bundle**

## 16 GAUGE TERMINAL POST

DESCRIPTION	PART NO.
2-3/8" x 5'6"	030562
2-3/8" x 6'	030563
2-3/8" x 7'	030565
2-3/8" x 8'	030567

**Case Pack - 37 Per Bundle** Available in other sizes and grades

## 18 GAUGE LINE POST

DESCRIPTION	PART NO.
1-5/8 x 5'6"	030191
1-5/8 x 8'	030196

**Case Pack - 61 Per Bundle**

## 17 GAUGE LINE POST

DESCRIPTION	PART NO.
1-5/8" x 5'6"	030152
1-5/8" x 6'	030153
1-5/8 x 7'	030155
1-5/8 x 8'	030157

**Case Pack - 61 Per Bundle** Available in other sizes and grades

## 16 GAUGE LINE POST

DESCRIPTION	PART NO.
1-5/8" x 6'	030543
1-5/8 x 7'	030545
1-5/8 x 8'	030547

**Case Pack - 61 Per Bundle**

# CASE PACK - STOCK REPLENISHMENT

## UPC Boxed Fittings



### TENSION BANDS

DESCRIPTION	PART NO.
2-3/8" Tension Band 70 per Display Box	087125
1-7/8" Tension Band 150 per Display Box	087001



### BRACE BANDS

DESCRIPTION	PART NO.
2-3/8" Brace Band 75 per Display Box	087126
1-7/8" Brace Band 200 per Display Box	087005



### RAIL END

DESCRIPTION	PART NO.
1-3/8" Die Cast Aluminum	087130

Case Pack - 50 per Display Box Available in other sizes and grade

### TENSIONBARS

DESCRIPTION	PART NO.
3/6" x 5/8" x 46" 25 per Pack	013603
3/16" x 5/8" x 58' 25 per Pack'	013604
3/16" x 5/8" x 70" 25 per Pack	013605

Available in other sizes and grades



### EYE TOPS

DESCRIPTION	PART NO.
1-5/8" x 1-3/8" DC Alum. 50 per Display Box	087129



### POST CAPS

DESCRIPTION	PART NO.
2-3/8" Plain Dome 50 per Display Box	087128
1-5/8" Plain Dome 200 per Display Box	087127
1-7/8" Plain Dome 100 per Display Box	087009

# CASE PACK - STOCK REPLENISHMENT



## SLEEVES

DESCRIPTION	PART NO.
1-3/8" x 6"	087090

Case Pack - 60 per Display Box *Available in other sizes and grades*



## TENSION WIRE

DESCRIPTION	PART NO.
9 Gauge Galvanized Coil Approx. 170'	087025

Case Pack - 1 (10 LB) Coil - sold by the each



## FENCES TIES

DESCRIPTION	PART NO.
6-1/2". 11 Gauge Aluminum Bags of qty 30	087036

Case Pack - 50 bags per Display Box

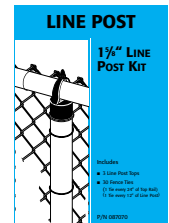

## LINE POST KIT (Pick a Pac)

DESCRIPTION	PART NO.
1-5/8 Line Post Kit - Pic A Pac	087070

Case Pack - 15 poly bags per Display Box



## CARRIAGE BOLTS

DESCRIPTION	PART NO.
5/16 X 1-1/4" - 60 Boxes of 20	087030
3/8 X 2" - 60 Boxes of 10	087032
3/8 X 3" - 40 Boxes of 10	087033

Case Pack - (60 or 40) Boxes per Display Box

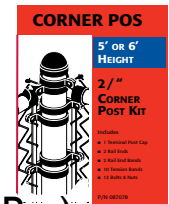

## CORNER POST KIT (Pick a Pac)

DESCRIPTION	PART NO.
2-3/8 Corner Post Kit 3' to 4' High Pic A Pac	087077
2-3/8 Corner Post Kit 5' to 6' High Pic A Pac	087078

Case Pack - 4' High = 12 bags, 6' High = 8 Bags per Box



## TENSION WIRE CLIPS

DESCRIPTION	PART NO.
12-1/2 Gauge Steel - Hog Rings	087037

Case Pack - 40 bags per Display Box



## END/GATE POST KIT (Pick a Pac)

DESCRIPTION	PART NO.
2-3/8 End/Gate Post Kit 3' to 4' High Pic A Pac	087073
2-3/8 End/Gate Post Kit 5' to 6' High Pic A Pac	087074

Case Pack - 4' High = 12 bags, 6' High = 8 Bags per Box

# CASE PACK - STOCK REPLENISHMENT



## ADJUSTABLE WOOD ADAPTER CLAMP

DESCRIPTION	PART NO.
2-3/8" Adustable Wood Adapter	087084

Case Pack - 40 per Display Box Available in other sizes and grade



## CORNER WOOD ADAPTER CLAMP

DESCRIPTION	PART NO.
2-3/8" Corner Wood Adapter	087100

Case Pack - 12 per Display Box Available in other sizes and grade



## POSTMASTER STEEL POST

DESCRIPTION	PART NO.
7'- 6" PostMaster Steel Post	633663
8' PostMaster Steel Post	633664
10' PostMaster Steel Post	633668

Case Pack - 100 per Pallet Available in other sizes

## PANEL CLAMP



DESCRIPTION	PART NO.
1-3/8" Panel Clamp (Bag of 2)	087053
1-5/8" Panel Clamp (Bag of 2)	087040

Case Pack - 20 bags per Display Box Available in other sizes

## GATE ELL (Corner)



DESCRIPTION	PART NO.
1-3/8"	087088

Case Pack - 40 per Display Box



## BARB ARM

DESCRIPTION	PART NO.
1 5/8 X 1 5/8 IPC BARB ARM	087055

Case Pack - 25 per Display Box



## GATE CLIP

DESCRIPTION	PART NO.
1-3/8". Gate Clip	087132

Case Pack - 100 per Display Box

# CHAIN LINK FENCE TOOLS



## POST DRIVER

DESCRIPTION	PART NO.
2" ID x 30" POST DRIVER 16 LBS	070653

Case Pack - 1 Sold by the each



## HOG RING PLIERS

DESCRIPTION	PART NO.
Hog Ring Pliers	087067

Case Pack - 10 Per Box



## 36" 3 HOOK STRECHER BAR

DESCRIPTION	PART NO.
36: 3 Hook Strecher Bar	070032

Case Pack - 1 Sold by the each



# CASE PACK - STOCK REPLENISHMENT



## GATE HARDWARE SETS

DESCRIPTION	PART NO.
2-3/8" x 1-3/8" Single Walk Gate Set	087079
2-3/8" x 1-3/8" Double Drive Gate Set	087080

Case Pack - 6 Poly Bags per Display Box

## BUTTERFLY LATCH

DESCRIPTION	PART NO.
1-3/8" X 2-3/8" Butterfly Latch	087048

Case Pack - 25 per Display Box

## FORK LATCH

DESCRIPTION	PART NO.
1-3/8" X 2-3/8" Fork Latch	087046

Case Pack - 30 per Display Box

## GRAVITY CLOSER LATCH

DESCRIPTION	PART NO.
2 3/8 x 1 3/8 Gravity Closer Latch	087095

Case Pack - 15 Per Box

## DRIVE GATE E-Z LATCH

DESCRIPTION	PART NO.
36" Drive Gate E-Z Latch	016901
42" Drive Gate E-Z Latch	016902

Case Pack - 10 per case

## DRIVE-GATE DROP ROD CANE

DESCRIPTION	PART NO.
44" Drop Rod Cane Assembly	087051

## GATE HARDWARE

### FRAME HINGE

DESCRIPTION	PART NO.
1-3/8 X 5/8 FRAME HINGE	087131

Case Pack - 60 per Display Box

### POST HINGE

DESCRIPTION	PART NO.
2-3/8 X 5/8 REG POST HINGE	087044

Case Pack - 55 per Display Box

### LAG SCREW HINGE

DESCRIPTION	PART NO.
5/8 x 4 1/2 LAG SCREW HINGE	087134

Case Pack - 25 per Display Box

### HANGER BOLT

DESCRIPTION	PART NO.
5/8 X 4-1/2 HANGER BOLT	087135

Case Pack - 25 per Display Box

### SWIVEL WHEEL

DESCRIPTION	PART NO.
Fits 1-3/8" Gate Frame	018360

Case Pack - 5 per Display Box

### DRIVE GATE DOUBLE-WHEEL

DESCRIPTION	PART NO.
1-5/8" or 1-7/8" 6" Drive Gate Wheels	018331
1-5/8" or 1-7/8" 8" Drive Gate Wheels	018332

# KENNELS



## COMPLETE KENNELS

DESCRIPTION	PART NO.
<b>4' High Bent Frame Kennels</b>	
6' W x 6' L x 4' H Complete Kennel	070914
6' W x 8' L x 4' H Complete Kennel	070913
6' W x 10' L x 4' H Complete Kennel	070916
<b>6' High Bent Frame Kennels</b>	
6' W x 6' L x 6' H Complete Kennel	070915
10' W x 10' L x 6' H Complete Kennel	070917
6' W x 12' L x 6' H Complete Kennel	071017

## KENNEL PANELS

DESCRIPTION	PART NO.
<b>4' High Bent Frame Kennel Panels</b>	
6' W x 4' H Gate Kennel Panel	070998
6' W x 4' H Side / End Panel	070997
8' W x 4' H Side / End Panel	070994
10' W x 4' H Side / End Panel	070999
<b>6' High Bent Frame Kennel Panels</b>	
6' W x 6' H Gate Kennel Panel	071010
10' W x 6' H Gate Kennel Panel	071012
6' W x 6' H Side / End Panel	071005
10' W x 6' H Side / End Panel	071014
12' W x 6' H Gate Kennel Panel	071015

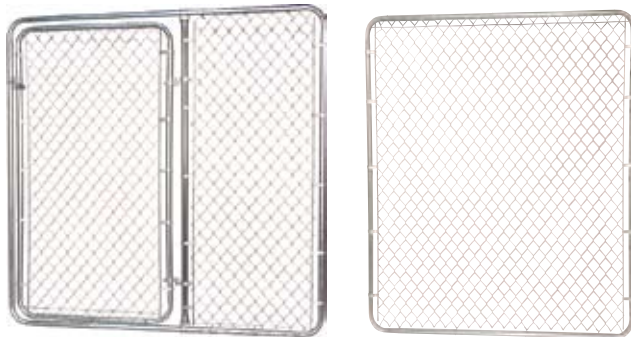

## KENNEL PRODUCTS



## BOXED KENNELS

DESCRIPTION	PART NO.
6' W x 6' L x 4' H Complete Boxed Kennel	087098
6' W x 10' L x 6' H Complete Boxed Kennel	087097
7 1/2' W x 13' L x 6' H Complete Boxed Kennel	087112

## SHADE-A-PET KENNEL COVER

DESCRIPTION	PART NO.
6' X 6' Shade-A-Pet Cover	071090
8' X 6' Shade-A-Pet Cover	071095
10' X 6' Shade-A-Pet Cover	071100
12' X 6' Shade-A-Pet Cover	071110
10' X 10' Shade-A-Pet Cover	071120

Case Pack - 5 per Box



## PANEL CLAMP

DESCRIPTION	PART NO.
1-3/8" Panel Clamp (Bag of 2)	087053

Case Pack - 20 bags per Display Box Available in other sizes

# CHOOSE YOUR CHAIN-LINK SYSTEM

## “Good or Better” Galvanized Chain-Link Systems: 5 or 12 Year Warranties

Galvanized residential chain-link fence systems have been preferred for decades to provide our economical choice to define property lines, enclose animals, and to protect and add value to property.

- Master Halco’s “GOOD” System contains 11-1/2 gauge galvanized chain-link with a 17 gauge framework. 5 year warranty.
- Master Halco’s “BETTER” System contains 9 gauge galvanized chain-link with a 16 gauge framework. 12 year warranty.

## “Best” Color Chain-Link Systems: 12-Year Warranty

The perfect choice of property owners who need the strength and protection of a chain-link fence system plus an appearance that blends beautifully with the environment.

- Master Halco’s “BEST” System contains 9 gauge chain-link and 16 gauge posts and 17 gauge top rail with the color choices below. 12-year warranty.



## How to determine materials required for Line of Fence in 6 easy steps:

- Step One:** Begin by sketching out a layout of your project as per the example below.
- Step Two:** Locate the terminal posts. Terminal posts are located anywhere the line of the fence stops or changes direction. This includes end/gate posts or corner posts.
- Step Three:** Measure the distance between terminal posts and total each line of fence. The line of fence sold by the foot in 10’ increments.
- Step Four:** Determine the number of gates required.
- Step Five:** Choose a Height.
- Step Six:** Choose Good, Better or Best.

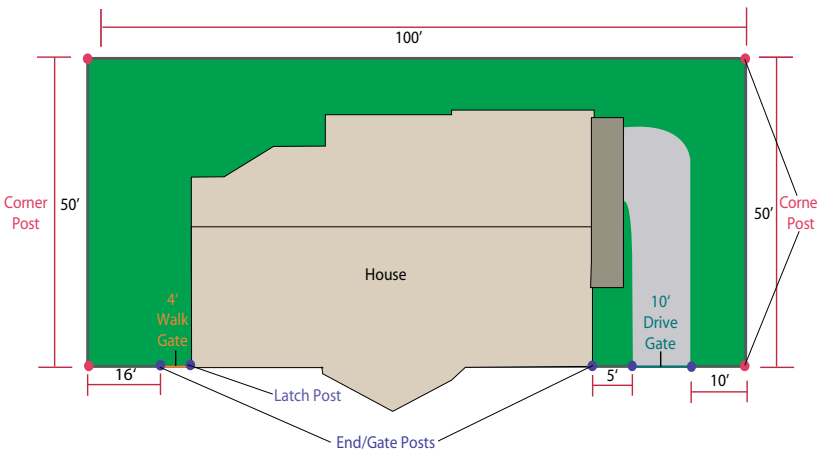

231 Feet of Fence, End/Gate Posts, 4 Corner Posts, 1 Latch Post, 1 Single Walk Gate, 1 Double Drive Gate

**Example: “Better” 4’ high fence, 9 gauge galvanized Pg 7**

Quantity	Descriptions	Part No.
*240’	Line Of Fence [10’ Increments]	011693
4	End/Gate Post Kit	086847
4	Corner Post Kit	086862
1	Latch Post (walk gate & house)	027017
1	Single Walk Gates 48” Opening	027017
1	Double Drive Gates 10’ Opening	027032
<b>OPTIONAL</b>		
2	Galv Tension Wire (10lb Coil 170’)	087025
1	Galv Hog Rings (264 per LB 1 per Ft)	023621

\*The reason for 240’ is because line of fence is sold by the foot in 10’ increments.

# GOOD, BETTER, BEST LINE OF FENCE

## Galvanized Systems: 5-Year Warranty

### Descriptions:

#### Line of Fence Include:

- 1-5/8" 17 gauge Line Post
- 1-3/8" 17 gauge Top Rail
- 11-1/2 gauge, 2-1/4" chain-link mesh
- Eye Tops
- Fence Ties

#### Post Kits Include:

- 2-3/8" 17 gauge Terminal Post
- Post Cap
- Brace Bands
- Tension Bands
- Rail Ends
- Tension Bars
- Bolts



\*All Line Of Fence gates include hardware for installation.  
Line Of Fence is sold by the foot in 10' increments.

## Choose a Height

### 4' HIGH

QTY.	DESCRIPTION	PART NO.
	Line Of Fence*	010613
	End/Gate Post Kit	011819
	Corner Post Kit	011829
	Latch Post Kit	011839
	Single Walk Gates 42" Opening	027002
	Single Walk Gates 48" Opening	027007
	Double Drive Gates 10' Opening	027022
	Double Drive Gates 12' Opening	027027

\*Additional Gates are available on page 19

### 5' HIGH

QTY.	DESCRIPTION	PART NO.
	Line Of Fence*	010614
	End/Gate Post Kit	011821
	Corner Post Kit	011831
	Latch Post Kit	011841
	Single Walk Gates 42" Opening	027003
	Single Walk Gates 48" Opening	027008
	Double Drive Gates 10' Opening	027023
	Double Drive Gates 12' Opening	027028

\*Additional Gates are available on page 19

### 6' HIGH

QTY.	DESCRIPTION	PART NO.
	Line Of Fence*	010615
	End/Gate Post Kit	011823
	Corner Post Kit	011833
	Latch Post Kit	011843
	Single Walk Gates 42" Opening	027004
	Single Walk Gates 48" Opening	027009
	Double Drive Gates 10' Opening	027024
	Double Drive Gates 12' Opening	027029

## OPTIONAL LOWER TENSION WIRE & CLIPS

DESCRIPTION	PART NO.
9 Gauge Tension Wire (Approx. 170')	087025
12 1/2 Gauge Hog Rings (Approx. 224 per LB.)	023601

# GOOD, BETTER, BEST LINE OF FENCE

## Galvanized Systems: 12-Year Warranty

### Descriptions:

#### Line of Fence Include:

- 1-5/8" 16 gauge Line Post
- 1-3/8" 16 gauge Top Rail
- **9 gauge, 2" chain-link mesh**
- Eye Tops
- Fence Ties

#### Post Kits Include:

- 2-3/8" 16 gauge Terminal Post
- Post Cap
- Brace Bands
- Tension Bands
- Rail Ends
- Tension Bars
- Bolts



\*All Line Of Fence gates include hardware for installation.  
 Line Of Fence is sold by the foot in 10' increments.

## Choose a Height

### 5' HIGH

QTY.	DESCRIPTION	PART NO.
	Line Of Fence*	011694
	End/Gate Post Kit	086848
	Corner Post Kit	086863
	Latch Post Kit	086878
	Single Walk Gates 42" Opening	027013
	Single Walk Gates 48" Opening	027018
	Double Drive Gates 10' Opening	027033
	Double Drive Gates 12' Opening	027038

\*Additional Gates are available on page 19

## OPTIONAL LOWER TENSION WIRE & CLIPS

DESCRIPTION	PART NO.
9 Gauge Tension Wire (Approx. 170')	087025
12 1/2 Gauge Hog Rings (Approx. 224 per LB.)	023601

\* sold by the foot in 10' increments

### 4' HIGH

QTY.	DESCRIPTION	PART NO.
	Line Of Fence*	011693
	End/Gate Post Kit	086847
	Corner Post Kit	086862
	Latch Post Kit	086877
	Single Walk Gates 42" Opening	027012
	Single Walk Gates 48" Opening	027017
	Double Drive Gates 10' Opening	027032
	Double Drive Gates 12' Opening	027037

\*Additional Gates are available on page 19

### 6' HIGH

QTY.	DESCRIPTION	PART NO.
	Line Of Fence*	011695
	End/Gate Post Kit	086849
	Corner Post Kit	086864
	Latch Post Kit	086879
	Single Walk Gates 42" Opening	027014
	Single Walk Gates 48" Opening	027019
	Double Drive Gates 10' Opening	027034
	Double Drive Gates 12' Opening	027039

\*Additional Gates are available on page 19

# GOOD, BETTER, BEST LINE OF FENCE

## Color Systems: 12-Year Warranty

### Descriptions:

#### Line of Fence Include:

- 1-5/8" 16 gauge Line Post
- 1-3/8" 17 gauge Top Rail
- **9 gauge, 2" chain-link mesh**
- Eye Tops
- Fence Ties

#### Post Kits Include:

- 2-3/8" 16 gauge Terminal Post
- Post Cap
- Brace Bands
- Tension Bands
- Rail Ends
- Tension Bars
- Bolts

\*All Line Of Fence gates include hardware for installation.  
Line Of Fence is sold by the foot in 10' increments.

## Choose a Height

### 5' HIGH

QTY.	DESCRIPTION	PART NO.
	Line Of Fence*	68024_
	End/Gate Post Kit	68154_
	Corner Post Kit	68164_
	Latch Post Kit	68174_
	Single Walk Gates 42" Opening	63173_
	Single Walk Gates 48" Opening	63178_
	Double Drive Gates 10' Opening	63183_
	Double Drive Gates 12' Opening	63188_

## OPTIONAL LOWER TENSION WIRE & CLIPS

DESCRIPTION	PART NO.
9 Gauge Color Tension Wire (Approx. 340')	51002_
Color Hog Rings (Approx. 224 per LB.)	62482_

## OPTIONAL TOUCH UP SPRAY PAINT

DESCRIPTION	PART NO.
Spray Touch Up Paint 13 oz.	62606_

When ordering, be sure to add the desired color code to the part number.  
Example: 68021\_ becomes 680212 for Midnight Black.



### 4' HIGH

QTY.	DESCRIPTION	PART NO.
	Line Of Fence*	68023_
	End/Gate Post Kit	68153_
	Corner Post Kit	68163_
	Latch Post Kit	68173_
	Single Walk Gates 42" Opening	63172_
	Single Walk Gates 48" Opening	63177_
	Double Drive Gates 10' Opening	63182_
	Double Drive Gates 12' Opening	63187_



### 6' HIGH

QTY.	DESCRIPTION	PART NO.
	Line Of Fence*	68025_
	End/Gate Post Kit	68155_
	Corner Post Kit	68165_
	Latch Post Kit	68175_
	Single Walk Gates 42" Opening	63174_
	Single Walk Gates 48" Opening	63179_
	Double Drive Gates 10' Opening	63184_
	Double Drive Gates 12' Opening	63189_



Forest Green



Midnight Black



Sierra Brown

Also available in Sierra Brown with extended Lead Time.

\* sold by the foot in 10' increments

# GALVANIZED CHAIN-LINK FENCE

## RESIDENTIAL COMPONENTS



### 17 GAUGE TOP RAIL

DESCRIPTION	PART NO.
1-3/8 x 21' Swedge End	030105

\*Sold by the foot in 21' lengths

### 16 GAUGE TOP RAIL

DESCRIPTION	PART NO.
1-3/8 x 21' Swedge End	030505

\*Sold by the foot in 21' lengths

### 11-1/2 GAUGE x 2-3/8" MESH

DESCRIPTION	PART NO.
4' High	056265
5' High	056266
6' High	056267

\*Sold in 50' Rolls Available in other sizes and grades

### 9 GAUGE x 2" MESH HEAVY DUTY

DESCRIPTION	PART NO.
4' High	056282
5' High	056283
6' High	056284

\*Sold in 50' Rolls Available in other sizes and grade



### 17 GAUGE LINE POST

DESCRIPTION	PART NO.
1-5/8" x 6'	030153
1-5/8 x 7'	030155
1-5/8 x 8'	030157

### 16 GAUGE LINE POST

DESCRIPTION	PART NO.
1-5/8" x 6'	030543
1-5/8 x 7'	030545
1-5/8 x 8'	030547



### 17 GAUGE TERMINAL POST

DESCRIPTION	PART NO.
2-3/8" x 6'	030173
2-3/8" x 7'	030175
2-3/8" x 8'	030177



### 16 GAUGE TERMINAL POST

DESCRIPTION	PART NO.
2-3/8" x 6'	030563
2-3/8" x 7'	030565
2-3/8" x 8'	030567

# GALVANIZED FITTINGS



## TENSION BANDS

DESCRIPTION	PART NO.
1-3/8"	010101
1-5/8"	010102
1-7/8"	010103
2-3/8"	010104
2-7/8"	010105



## BRACE BANDS

DESCRIPTION	PART NO.
1-5/8"	010302
1-7/8"	010303
2-3/8"	010304
2-7/8"	010305



## POST CAPS

DESCRIPTION	PART NO.
1-5/8" Aluminum	011302
1-7/8" Aluminum	011303
2-3/8" Aluminum	011304
1-5/8" Steel	011602
1-7/8" Steel	011603
2-3/8" Steel	011604
2-7/8" Steel	011605



## EYE TOPS

DESCRIPTION	PART NO.
1-5/8" x 1-3/8" Die Cast Aluminum	011901
1-7/8" x 1-3/8" Die Cast Aluminum	011902
1-5/8" x 1-5/8" Pressed Steel Heavy Duty	012252
1-7/8" x 1-5/8" Pressed Steel Heavy Duty	012253
2-3/8" x 1-5/8" Pressed Steel Heavy Duty	012254
2-7/8" x 1-5/8" Pressed Steel Heavy Duty	012255



## RAIL END

DESCRIPTION	PART NO.
1-3/8" Die Cast Aluminum	012301
1-5/8" Die Cast Aluminum	012302
1-5/8" Steel Heavy Duty	012506
1-5/8" Steel Combo	012511

## TENSION BARS

DESCRIPTION	PART NO.
3/16" x 5/8" x 34"	013601
3/16" x 5/8" x 40"	013602
3/6" x 5/8" x 46"	013603
3/16" x 5/8" x 58"	013604
3/16" x 5/8" x 70"	013605
3/16" x 3/4" x 70"	013705
3/16" x 3/4" x 82"	013706
3/16" x 3/4" x 94"	013707
3/16" x 3/4" x 118"	013709
3/16" x 3/4" x 142"	013710



# GALVANIZED FITTINGS



Phone: 1-888-289-3362  
 FAX: 1-800-542-8488  
 MasterHalco.com

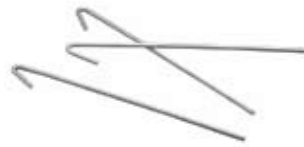

## FENCES TIES

DESCRIPTION	PART NO.
6-1/2". 9 Gauge Aluminum	023552
8-1/4". 9 Gauge Aluminum	023553

\*Sold in bags of 100 Also available in other grades and lengths



## ADJUSTABLE WOOD ADAPTER

DESCRIPTION	PART NO.
2-3/8"	011082

## TENSION WIRE CLIPS

DESCRIPTION	PART NO.
12-1/2 Gauge Steel	023601

\*Sold by the pound, approx. 224 rings per pound



## CORNER WOOD ADAPTER

DESCRIPTION	PART NO.
2-3/8"	011162

## TENSION WIRE

DESCRIPTION	PART NO.
9 Gauge Galvanized Coil	087025

\*10 pound coil approx. 170'



## PANEL CLAMPS

DESCRIPTION	PART NO.
1-3/8" x 1-3/8"	015516

## CARRIAGE BOLTS

DESCRIPTION	PART NO.
5/16 X 1-1/4"	010701
5/16 X 2"	010715
5/16 X 2-1/4"	010716
3/8 X 2"	010706
3/8 X 2-1/4"	010707
3/8 X 3"	010710



## BRACE/END RAIL CLAMPS

DESCRIPTION	PART NO.
1-3/8" x 1-3/8"	015501
2-3/8" x 1-5/8"	015505



## SLEEVES

DESCRIPTION	PART NO.
1-3/8" x 6"	012601
1-5/8" x 6"	012602



## BARB WIRE ARMS

DESCRIPTION	PART NO.
1-5/8" x 1-5/8"	013107
1-7/8" x 1-5/8"	013108
2-3/8" x 1-5/8"	013109



# GALVANIZED FITTINGS



## UNIVERSAL GATE ELL

DESCRIPTION	PART NO.
1-3/8"	015103



## BUTTERFLY LATCHES

DESCRIPTION	PART NO.
1-3/8" x 1-7/8"	017303
1-3/8" x 2-3/8"	017304



## FRAME HINGES

DESCRIPTION	PART NO.
1-3/8" x 5/8"	014104
1-5/8" x 5/8"	014105
1-7/8" x 5/8"	014106



## POST HINGES

DESCRIPTION	PART NO.
1-7/8" x 5/8"	014326
2-3/8" x 5/8"	014328
2-7/8" x 5/8" Heavy Duty	014310



## FORK LATCH ASSEMBLIES

DESCRIPTION	PART NO.
1 3/8" x 2 3/8"	016703
1 3/8" x 1 7/8"	016704
1 5/8" x 2 3/8"	016705
1 5/8" x 2 7/8"	016706

## DRIVE GATE E-Z LATCH

DESCRIPTION	PART NO.
1-3/8" x 36"	016901
1-3/8" x 42"	016902



## GATE HARDWARE SETS

DESCRIPTION	PART NO.
2-3/8" x 1-3/8" Single Walk Gate Set	087079
2-3/8" x 1-3/8" Double Drive Gate Set	087080

# GALVANIZED GATES



## SINGLE WALK GATES 1-3/8" Round Corner Galvanized

OPENING	PART NO.
4' HIGH	
3' Opening	021603
39" Opening	021608
42" Opening	021613
4' Opening	021618
5' HIGH	
3' Opening	021604
39" Opening	021609
42" Opening	021614
4' Opening	021619
6' HIGH	
3' Opening	021605
39" Opening	021610
42" Opening	021615
4' Opening	021620



## DOUBLE DRIVE GATES 1-3/8" Round Corner Galvanized

OPENING	PART NO.
4' HIGH	
10' Opening	021663
12' Opening	021673
5' HIGH	
10' Opening	021664
12' Opening	021674
6' HIGH	
10' Opening	021665
12' Opening	021675



## SINGLE WALK GATES 1-3/8" Square Ell Corner Galvanized

OPENING	PART NO.
4' HIGH	
3' Opening	025502
42" Opening	025507
4' Opening	025512
5' HIGH	
3' Opening	025503
42" Opening	025508
4' Opening	025513
6' HIGH	
3' Opening	025504
42" Opening	025509
4' Opening	025514

*\*Available in Galvanized, Forest Green & Midnight Black*



## DOUBLE DRIVE GATES 1-3/8" Square Ell Corner Galvanized

OPENING	PART NO.
4' HIGH	
10' Opening	025542
12' Opening	025547
5' HIGH	
10' Opening	025543
12' Opening	025548
6' HIGH	
10' Opening	025544
12' Opening	025549

*Additional sizes available in Galvanized, Forest Green & Midnight Black*

# COLOR CHAIN-LINK FENCE

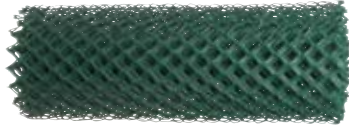

## 9 GAUGE X 2" MESH (VINYL COLOR COATED)

DESCRIPTION	PART NO.
4' High	51417_
5' High	51418_
6' High	51419_

\*Sold in 50' Rolls



## 17 GAUGE TOP RAIL

DESCRIPTION	PART NO.
1-3/8 x 21' SE	66001_

\*Sold by the foot in 21' lengths



## 16 GAUGE LINE POST

DESCRIPTION	PART NO.
1-5/8 x 6'	65043_
1-5/8 x 7'	65045_
1-5/8 x 8'	65047_



## 16 GAUGE TERMINAL POST END/GATE/CORNER/LATCH POST

DESCRIPTION	PART NO.
2-3/8" x 6'	65063_
2-3/8" x 7'	65065_
2-3/8" x 8'	65067_

When ordering, be sure to add the desired color code to the part number.  
Example: 68021\_ becomes 680212 for Midnight Black.

## TENSION BARS



DESCRIPTION	PART NO.
1/4" x 3/4" x 46" Fiberglass	60797_
1/4" x 3/4" x 58" Fiberglass	60798_
1/4" x 3/4" x 70" Fiberglass	60799_



## TENSION BANDS

DESCRIPTION	PART NO.
1-5/8"	60002_
2-3/8"	60004_



## BRACE BANDS

DESCRIPTION	PART NO.
1-5/8"	60082_
2-3/8"	60084_



## POST CAPS

DESCRIPTION	PART NO.
1-5/8"	60237_
2-3/8"	60239_



## EYE TOPS

DESCRIPTION	PART NO.
1-5/8" x 1-3/8" Die Cast	60301_

# COLOR FITTINGS



Phone: 1-888-289-3362  
 FAX: 1-800-542-8488  
 MasterHalco.com



## RAIL ENDS



DESCRIPTION	PART NO.
1-3/8"	60631_

## TOUCH-UP PAINT

DESCRIPTION	PART NO.
Spray Touch Up Paint	62606_



## RAIL SLEEVES



DESCRIPTION	PART NO.
1-3/8" x 6"	60711_

## GATE HARDWARE SETS

DESCRIPTION	PART NO.
2-3/8" x 1-3/8" Color Single Walk Gate Set	68195_
2-3/8" x 1-3/8" Color Double Drive Gate Set	68196_

## BRACE/END RAIL CLAMPS



DESCRIPTION	PART NO.
1-3/8" x 1-3/8" End	61481_
1-5/8" x 1-5/8" End	61484_

## FORK LATCH ASSEMBLIES



DESCRIPTION	PART NO.
1-3/8" x 2-3/8"	48055_
1-5/8" x 2-3/8"	48056_

## FENCE TIES



DESCRIPTION	PART NO.
6-1/2" x 9 gauge Aluminum Ties	62572_
8-1/2" x 9 gauge Aluminum Ties	62573_

## FRAME HINGES



DESCRIPTION	PART NO.
1-3/8" x 5/8"	60863_
1-5/8" x 5/8"	60881_

*Actual product is smooth wire*

## TENSION WIRE & HOG RINGS



DESCRIPTION	PART NO.
Tension Wire 10 pound coil	51002_
Hog Rings	62482_

*\*Approximately 340' in length*

*\*Sold by the pound - Approximately 132 Per Pound*

## POST HINGES



DESCRIPTION	PART NO.
1-7/8" x 5/8"	60897_
2-3/8" x 5/8"	60898_

When ordering, be sure to add the desired color code to the part number.  
 Example: 61314\_ becomes 613142 for Midnight Black.



Forest Green



Midnight Black



Sierra Brown

# COMMERCIAL GRADE CHAIN-LINK

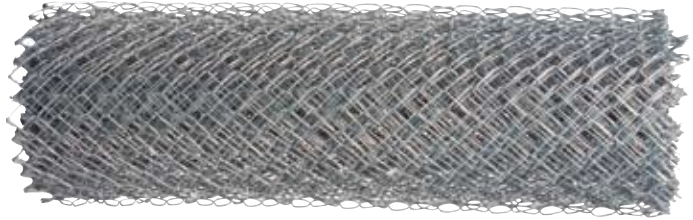

## 9 GAUGE X 2" MESH Knuckle Twist 0.148" GAW - ASTM A 392, Class I

### TOP RAIL CQ20 Commercial Grade

DESCRIPTION	PART NO.
1-5/8" x 21 Plain End	032605
1-5/8" x 21 Swedge End	032608

*\*Sold by the foot in 21' Lengths Also available in other grades and lengths*

DESCRIPTION	PART NO.
6' High	055406
7' High	055460
8' High	055464
10' High	055466
12' High	055469

*\*Sold by the foot in 50' Rolls Also available in Knuckle Knuckle & TT*

### TERMINAL POSTS 2-7/8" CQ20 Commercial Grade

DESCRIPTION	PART NO.
2-7/8" x 7'	032684
2-7/8" x 8'	032686
2-7/8" x 9'	032687
2-7/8" x 10'	032688
2-7/8" x 10'6"	032689
2-7/8" x 11'	032692
2-7/8" x 12'	032694
2-7/8" x 13'	032695

### LINE / TERMINAL POSTS 1-7/8" CQ20 Commercial Grade

DESCRIPTION	PART NO.
1-7/8" x 6'	032652
1-7/8" x 7'	032654
1-7/8" x 8'	032656
1-7/8" x 9'	032658

*\*Also available in other sizes and grades.*

### TERMINAL POSTS 2-3/8" CQ20 Commercial Grade

DESCRIPTION	PART NO.
2-3/8" x 6'	032672
2-3/8" x 7'	032674
2-3/8" x 8'	032676
2-3/8" x 9'	032678
2-3/8" x 10'	032679
2-3/8" x 10'6"	032680
2-3/8" x 11'	032681
2-3/8" x 12'	032683
2-3/8" x 13'	032685



# COMMERCIAL GRADE CHAIN-LINK



## TOP RAIL DQ40 Commercial Grade ASTM F 1043 Group IC

DESCRIPTION	PART NO.
1-5/8" x 21 Plain End	033005

*\*Sold by the foot in 21' Lengths Also available in other grades and lengths*

## LINE POSTS 1-7/8" DQ40 Commercial Grade ASTM F 1043

DESCRIPTION	PART NO.
1-7/8" x 6'	033043
1-7/8" x 7'	033044
1-7/8" x 8'	033046
1-7/8" x 9'	033048

*\*Also available in other sizes and grades.*

## TERMINAL POSTS 2-3/8" DQ40 Commercial Grade ASTM F 669

DESCRIPTION	PART NO.
2-3/8" x 6'	033052
2-3/8" x 7'	033054
2-3/8" x 8'	033056
2-3/8" x 8'8"	033057
2-3/8" x 9'	033058
2-3/8" x 10'	033059
2-3/8" x 10'6"	033063
2-3/8" x 11'	033061
2-3/8" x 12'	033060

## TERMINAL POSTS 2-7/8" DQ40 Commercial Grade ASTM F 669

DESCRIPTION	PART NO.
2-7/8" x 8'	033076
2-7/8" x 9'	033078
2-7/8" x 10'	033079
2-7/8" x 11'	033080
2-7/8" x 12'	033081
2-7/8" x 13'	033082
2-7/8" x 15'	033084

*\*Also available in other sizes and grades*



# CHAIN LINK SLATS



## CHAIN LINK SLATS (Sold in bags of 10 Linear Feet)

### 2" MESH 9 OR 11 GAUGE

DESCRIPTION	PART NO.
4' Fence Height	20282_
5' Fence Height	20283_
6' Fence Height	20284_
7' Fence Height	20285_
8' Fence Height	20286_
10' Fence Height	20288_
12' Fence Height	20289_



### 2-1/4" MESH 11-1/2 OR 12-1/2 GAUGE

DESCRIPTION	PART NO.
4' Fence Height	20371_
5' Fence Height	20372_
6' Fence Height	20373_

*\*Additional sizes and colors available*



When ordering, be sure to add the desired color code to the part number.  
Example: 20369\_ becomes 203693 for Sierra Brown.

Master Halco will not be responsible for fence damage resulting from wind load conditions due to insufficient structural support. Wind load and privacy factor approximately 75%. Please call our Customer Service Center for additional details (888) 289-3362.



# AGRICULTURAL WIRE FENCING



## HORSE FENCE -NON CLIMB

DESCRIPTION	PART NO.
48" x 100' Horse Fence	036184
60" x 100' Horse Fence	036188
72" x 100' Horse Fence	036189

Case Pack - 9 Rolls per Pallet

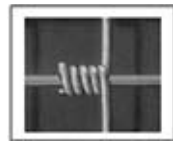

## FIELD FENCE

DESCRIPTION	PART NO.
47" x 300' Field Fence	036207

Case Pack - 9 Rolls per Pallet



## BARBED WIRE

DESCRIPTION	PART NO.
2 Point 12.75 GA x 1320' Import	013502
4 Point 12.75 GA x 1320' Import	013501
4 Point 12.5 GA Spec Class 3 Import 1320'	013526
4 Point 12.5 GA Spec Class 3 Domestic 1320'	013505

Case Pack - 27 Rolls per Pallet



## FENCE STAYS

DESCRIPTION	PART NO.
42" Galvanized	013516

Case Pack - 100 per Bundle

## BARBLESS WIRE

DESCRIPTION	PART NO.
12.50 GA x 1320'	013531

Case Pack - 27 Rolls per Pallet

# COLONIAL ORNAMENTAL ALUMINUM

Colonial Aluminum® fences offer a variety of design styles to choose from to customize the look of your property. All panels come in 6' rackable sections which beautifully adjust to the contours of your land. They also offer the beauty of a screwless design for that desired "good neighbor" look. Aluminum fences offer you an attractive ornamental fence with the classic looks of wrought iron, but are easier to maintain than iron. With the added benefit of a Lifetime Limited Warranty you have the comfort of knowing your investment will last for years to come. Colonial Aluminum fences are also a strong alternative to steel with their durable construction and lower costs.

## Features & Benefits

- Aluminum panels and posts that never develop red rust cost less to maintain and are ideal for poolside fencing.
- Easy rackability up to 20" over 6' for flexibility over uneven terrain. Adjusts 20 inches over 6 feet.
- Durable polyester TGIC powder coating resists fading and scratches for a lasting look
- Screwless panels for a clean "good neighbor" look
- Gates which have welded rails and pickets for added strength and durability
- Assembled sections for quick and easy installation
- Lifetime limited warranty
- Many styles available to suit your needs: Universal, Spear, Universal Spear, Picket, and Staggered Spear



Shown: Colonial Universal Spear Flush Panels



# COLONIAL ORNAMENTAL ALUMINUM

## Swimming Pool Fence Solutions

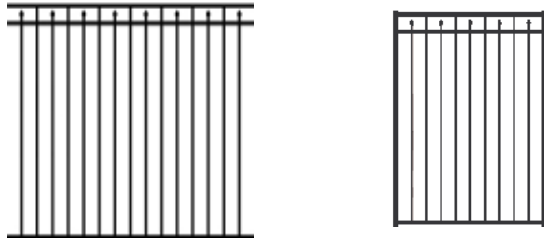

### Universal Spear 3 Rail Flush Panel

DESCRIPTION	PART NO.
-------------	----------

54" High x 6' Wide Universal Spear 3 Rail Panel\* 721822

\* Panel meets 1993 BOCA pool code Check local codes for compliance

### Universal 3 Rail Spear Flush Gate

DESCRIPTION	PART NO.
-------------	----------

54" High x 4' Wide Universal Spear 3 Rail Gate 721962

54" High x 5' Wide Universal Spear 3 Rail Gate 722102

### Universal 3 Rail Spear Flush Posts

DESCRIPTION	PART NO.
-------------	----------

84" High x 2" Square **Line Post** for 54" US3RF 722362

84" High x 2" Square **End Post** for 54" US3RF 722372

84" High x 2" Square **Corner Post** 54" US3RF 722382

84" High x 2" Square **Gate Post** for 54" US3RF 722392

Post Caps Sold Separately - see page 12

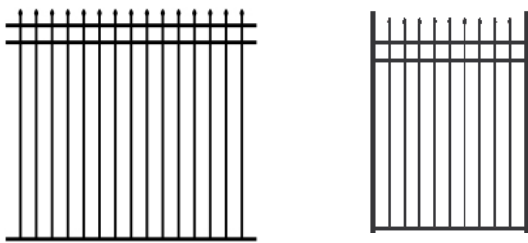

### Spear 3 Rail Flush Panel

DESCRIPTION	PART NO.
-------------	----------

57" High x 6' Wide Spear 3 Rail Flush Panel\* 721782

\* Panel meets 1993 BOCA pool code Check local codes for compliance

### Spear 3 Rail Flush Gate

DESCRIPTION	PART NO.
-------------	----------

57" High x 4' Wide Spear 3 Rail Flush Gate 721922

57" High x 5' Wide Spear 3 Rail Flush Gate 722062

### Spear 3 Rail Flush Posts

DESCRIPTION	PART NO.
-------------	----------

90" High x 2" Square **Line Post** for 57" S3RF 722442

90" High x 2" Square **End Post** for 57" S3RF 722452

90" High x 2" Square **Corner Post** 57" S3RF 722462

90" High x 2" Square **Gate Post** for 57" S3RF 722472

Post Caps Sold Separately - see page 12

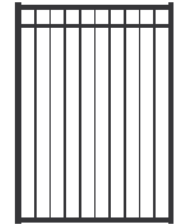
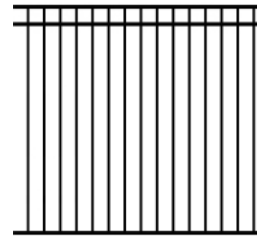

### Universal 3 Rail Flush Fence Panel

DESCRIPTION	PART NO.
-------------	----------

54" High x 6' Wide Universal 3 Rail Flush Panel\* 721712

\* Panel meets 1993 BOCA pool code Check local codes for compliance

Also available in 6' Height

### Universal 3 Rail Flush Gate

DESCRIPTION	PART NO.
-------------	----------

54" High x 4' Wide Universal 3 Rail Flush Gate 721852

54" High x 5' Wide Universal 3 Rail Flush Gate 721992

### Universal 3 Rail Flush Posts

DESCRIPTION	PART NO.
-------------	----------

84" High x 2" Square **Line Post** for 54" U3RF 722362

84" High x 2" Square **End Post** for 54" U3RF 722372

84" High x 2" Square **Corner Post** 54" U3RF 722382

84" High x 2" Square **Gate Post** for 54" U3RF 722392

Post Caps Sold Separately - see page 12



### Hinge & Latch Solutions

DESCRIPTION	PART NO.
-------------	----------

TruClose Hinge (self closing gate hinge) qty 2 044440

TruClose Hinge w/Legs (self closing ) qty 2 448252

MagnaLatch - Top Pull (locking latch) 044430

MagnaLatch - Vertical Pull (locking latch) 044432

See page 14 for additional Hinge & Latch options

All product dimensions are nominal. For actual sizes contact Master Halco at:

Ph# 1-888-289-3362

# COLONIAL ORNAMENTAL ALUMINUM



Shown: Universal Top 3 Rail Panels

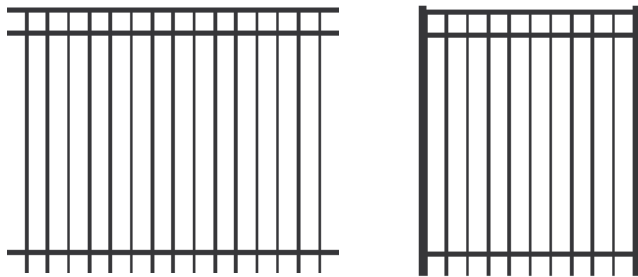

## Colonial Aluminum® Fencing

Colonial Aluminum® fences offer a variety of design styles to customize the look of your property. All styles are rackable to slopes in your landscape.

- Adjusts up to 20" over 6' run to adapt for hills & slopes
- Durable Polyester TGIC powder coating
- Lifetime limited manufacturer warranty
- Proudly made in the U.S.A.

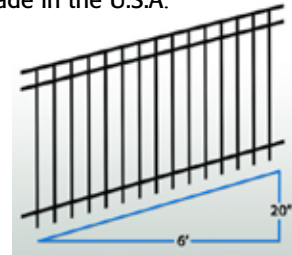

### Universal Top 3 Rail Fence Panel

DESCRIPTION	PART NO.
4' High x 6' Wide 3 Rail Universal Top Panel	721702
5' High x 6' Wide 3 Rail Universal Top Panel	721722
6' High x 6' Wide 3 Rail Universal Top Panel	721732

### Universal Top 3 Rail Gate

DESCRIPTION	PART NO.
4' High x 4' Wide 3 Rail Universal Top Gate	721842
4' High x 5' Wide 3 Rail Universal Top Gate	721982
5' High x 4' Wide 3 Rail Universal Top Gate	721862
5' High x 5' Wide 3 Rail Universal Top Gate	722002
6' High x 4' Wide 3 Rail Universal Top Gate	721872
6' High x 5' Wide 3 Rail Universal Top Gate	722012

### Universal Top 3 Rail Posts

DESCRIPTION	PART NO.
<b>4' High Fence Posts</b>	
78" High x 2" Square <b>Line Post</b> for 4' UT 3 Rail	722122
78" High x 2" Square <b>End Post</b> for 4' UT 3 Rail	722132
78" High x 2" Square <b>Corner Post</b> 4' UT 3 Rail	722142
78" High x 2" Square <b>Gate Post</b> for 4' UT 3 Rail	722152
<b>5' High Fence Posts</b>	
90" High x 2" Square <b>Line Post</b> for 5' UT 3 Rail	722162
90" High x 2" Square <b>End Post</b> for 5' UT 3 Rail	722172
90" High x 2" Square <b>Corner Post</b> 5' UT 3 Rail	722182
90" High x 2" Square <b>Gate Post</b> for 5' UT3 Rail	722192
<b>6' High Fence Posts</b>	
102" High x 2" Square <b>Line Post</b> for 6' UT 3Rail	722202
102" High x 2" Square <b>End Post</b> for 6' UT 3 Rail	722212
102" High x 2" Square <b>Corner Post</b> 6' UT 3Rail	722222
102" High x 2" Square <b>Gate Post</b> for 6' UT3Rail	722232

All product dimensions are nominal. For actual sizes contact Master Halco at:  
 Ph# 1-888-289-3362

Post Caps Sold Separately - see page 12



# COLONIAL ORNAMENTAL ALUMINUM



Shown: Universal Top 3 Rail Flush Panels

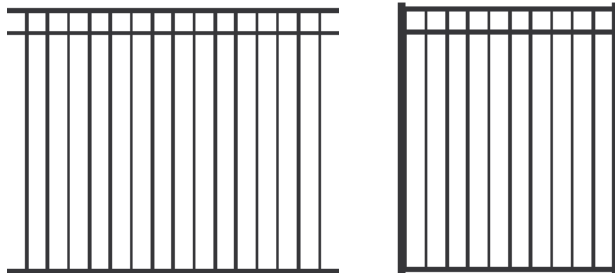

## Universal Top 3 Rail Flush Posts

DESCRIPTION	PART NO.
<b>54" High Fence Posts</b>	
84" High x 2" Square <b>Line Post</b> for 54" UTF 3 Rail	722362
84" High x 2" Square <b>End Post</b> for 54" UTF 3 Rail	722372
84" High x 2" Square <b>Corner Post</b> for 54" UTF 3Rail	722382
84" High x 2" Square <b>Gate Post</b> for 54" UTF 3Rail	722392
<b>6' High Fence Posts</b>	
102" High x 2" Square <b>Line Post</b> for 6' UTF 3Rail	722402
102" High x 2" Square <b>End Post</b> for 6' UTF 3Rail	722412
102" High x 2" Square <b>Corner Post</b> 6' UTF 3Rail	722422
102" High x 2" Square <b>Gate Post</b> for 6'UTF 3Rail	722432

Post Caps Sold Separately - see page 12

All product dimensions are nominal. For actual sizes contact Master Halco at:  
Ph# 1-888-289-3362

## Universal Top 3 Rail Flush Fence Panel

DESCRIPTION	PART NO.
54" High x 6' Wide Universal Top 3 Rail Flush*	721712
6' High x 6' Wide Universal Top 3 Rail Flush*	721742

\* Panel meets 1993 BOCA pool code Check local codes for compliance

## Universal Top 3 Rail Flush Gate

DESCRIPTION	PART NO.
54" High x 4' Wide Universal Top 3 Rail Flush	721852
54" High x 5' Wide Universal Top 3 Rail Flush	721992
6' High x 4' Wide 3 Universal Top 3 Rail Flush	721882
6' High x 5' Wide 3 Universal Top 3 Rail Flush	722022

Two Walk Gates can be used to create a Drive Gate

# COLONIAL ORNAMENTAL ALUMINUM



Shown: Universal Top 2 Rail Flush Panels

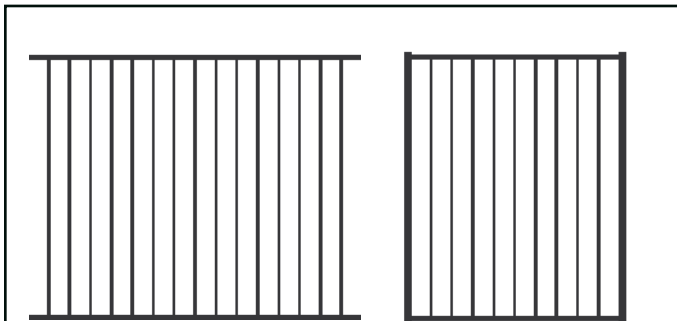

## Universal Top 2 Rail Flush Fence Panel

DESCRIPTION	PART NO.
4' High x 6' Wide Universal 2 Rail Flush Panel	721802

## Universal Top 2 Rail Flush Gate

DESCRIPTION	PART NO.
4' High x 4' Wide Universal 2 Rail Flush Gate	721942
4' High x 5' Wide Universal 2 Rail Flush Gate	722082

Two Walk Gates can be used to create a Drive Gate

## Universal Top 2 Rail Flush Posts

DESCRIPTION	PART NO.
78" High x 2" Square <b>Line Post</b> for 4' U2RF	722122
78" High x 2" Square <b>End Post</b> for 4' U2RF	722132
78" High x 2" Square <b>Corner Post</b> 4' U2RF	722142
78" High x 2" Square <b>Gate Post</b> for 4' U2RF	722152

Post Caps Sold Separately

All product dimensions are nominal. For actual sizes contact Master Halco at:  
 Ph# 1-888-289-3362

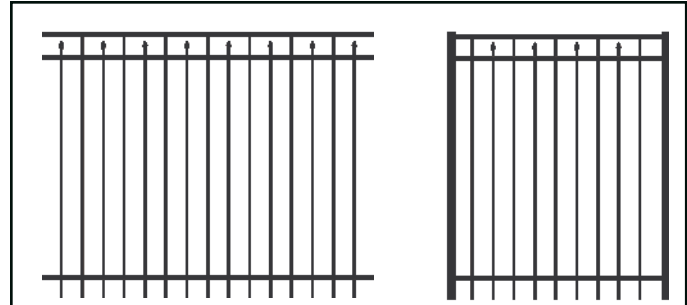

## Universal Spear 3 Rail Fence Panel

DESCRIPTION	PART NO.
4' High x 6' Wide Universal Spear 3 Rail Panel	721812

## Universal Spear 3 Rail Gate

DESCRIPTION	PART NO.
4' High x 4' Wide Universal Spear 3 Rail Gate	721952
4' High x 5' Wide Universal Spear 3 Rail Gate	722092

## Universal Spear 3 Rail Posts

DESCRIPTION	PART NO.
78" High x 2" Square <b>Line Post</b> for 4' US 3 Rail	722122
78" High x 2" Square <b>End Post</b> for 4' US 3 Rail	722132
78" High x 2" Square <b>Corner Post</b> 4' US 3 Rail	722142
78" High x 2" Square <b>Gate Post</b> for 4' US3 Rail	722152

Post Caps Sold Separately

## Accessories

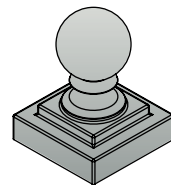

Ball Cap

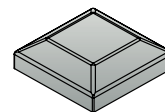

Flat Cap

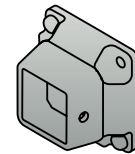

Flat Bracket



Touch Up Paint

Drive Gate Drop Rod

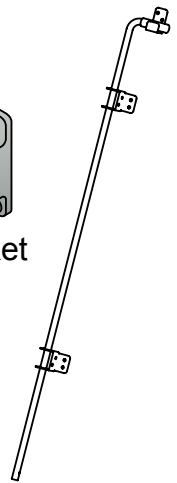

## Colonial Accessories

DESCRIPTION	PART NO.
Ball Post Cap for 2" Posts	722592
Flat Post Cap for 2" Post	722582
Wall Mount Flat Bracket	722762
Drive Gate Drop Rod	725012
Touch-up Paint - Aerosol Spray	722602
Notching Tool	722622



# COLONIAL ORNAMENTAL ALUMINUM

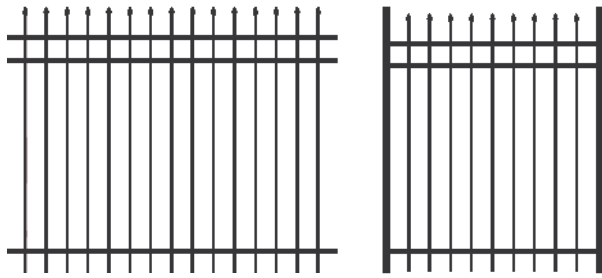

## Spear Top 3 Rail Fence Panel

DESCRIPTION	PART NO.
4 High x 6' Wide Spear Top 3 Rail Panel	721752
5 High x 6' Wide Spear Top 3 Rail Panel	721762
6 High x 6' Wide Spear Top 3 Rail Panel	721772

## Spear Top 3 Rail Gate

DESCRIPTION	PART NO.
4' High x 4' Wide Spear Top 3 Rail Gate	721892
4' High x 5' Wide Spear Top 3 Rail Gate	722032
5' High x 4' Wide Spear Top 3 Rail Gate	721902
5' High x 5' Wide Spear Top 3 Rail Gate	722042
6' High x 4' Wide Spear Top 3 Rail Gate	721912
6' High x 5' Wide Spear Top 3 Rail Gate	722052

*Two Walk Gates can be used to create a Drive Gate*

## Spear Top 3 Rail Posts

DESCRIPTION	PART NO.
<b>4' High Fence Posts</b>	
78" High x 2" Square <b>Line Post</b> for 4' ST 3 Rail	722242
78" High x 2" Square <b>End Post</b> for 4' ST 3 Rail	722252
78" High x 2" Square <b>Corner Post</b> 4' ST 3 Rail	722262
78" High x 2" Square <b>Gate Post</b> for 4' ST 3 Rail	722272
<b>5' High Fence Posts</b>	
90" High x 2" Square <b>Line Post</b> for 5' ST 3 Rail	722282
90" High x 2" Square <b>End Post</b> for 5' ST 3 Rail	722292
90" High x 2" Square <b>Corner Post</b> 5' ST 3 Rail	722302
90" High x 2" Square <b>Gate Post</b> for 5' ST3 Rail	722312
<b>6' High Fence Posts</b>	
102" High x 2" Square <b>Line Post</b> for 6' ST 3Rail	722322
102" High x 2" Square <b>End Post</b> for 6' ST 3 Rail	722332
102" High x 2" Square <b>Corner Post</b> 6' ST 3Rail	722342
102" High x 2" Square <b>Gate Post</b> for 6' ST3Rail	722352

*Post Caps Sold Separatley - see page 12*

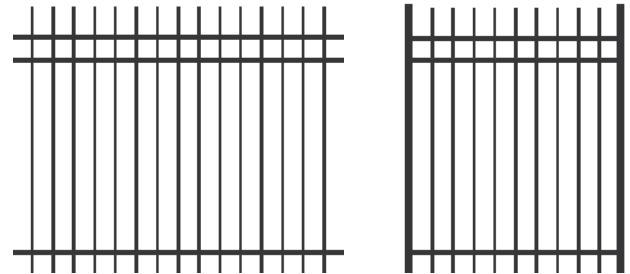

## Picket Top 3 Rail Fence Panel

DESCRIPTION	PART NO.
4' High x 6' Wide Picket Top 3 Rail Panel	721792

## Picket Top 3 Rail Gate

DESCRIPTION	PART NO.
4' High x 4' Wide Picket Top 3 Rail Gate	721932
4' High x 5' Wide Picket Top 3 Rail Gate	722072

*Two Walk Gates can be used to create a Drive Gate*

## Picket Top 3 Rail Posts

DESCRIPTION	PART NO.
78" High x 2" Square <b>Line Post</b> for 4' P3R	722242
78" High x 2" Square <b>End Post</b> for 4' P3R	722252
78" High x 2" Square <b>Corner Post</b> 4' P3R	722262
78" High x 2" Square <b>Gate Post</b> for 4' P3R	722272

*Post Caps Sold Separatley - see page 12*

*All product dimensions are nominal. For actual sizes contact Master Halco at:  
Ph# 1-888-289-3362*

# MONTAGE<sup>®</sup> CLASSIC ORNAMENTAL STEEL

## Montage ATF<sup>™</sup> by Ameristar<sup>®</sup> CLASSIC

Traditional spear-pointed pickets extend through the top rail to form the popular Classic design.

- Adjusts up to 30" over 8' run to adapt for hills & slopes
- 20 year limited manufacturer warranty on panels
- Maintenance free ornamental fencing
- Proudly made in the U.S.A.



**Classic 3 Rail**



**Classic 2 Rail**

### Classic 3 Rail



### Classic 2 Rail Panel

DESCRIPTION	PART NO.
4' High (46" Net) Classic 2 Rail ATF Panel	890122
5' High (58" Net) Classic 2 Rail ATF Panel *	890132

\* Meets 1993 BOCA pool code standards Check Local codes for compliance.

### Classic 2 Rail Gate

DESCRIPTION	PART NO.
4' Width 4' High Classic 2 Rail Gate	891332
5' Width 4' High Classic 2 Rail Gate	891342
4' Width 5' High Classic 2 Rail Gate	891392
5' Width 5' High Classic 2 Rail Gate	891402

Two Walk Gates can be used to create a Drive Gate

### Classic 3 Rail Panel

DESCRIPTION	PART NO.
4' High (46" Net) Classic 3 Rail ATF Panel	890182
5' High (58" Net) Classic 3 Rail ATF Panel	890192
6' High (70" Net) Classic 3 Rail ATF Panel *	890202

\* Meets 1993 BOCA pool code standards Check Local codes for compliance.

### Classic 3 Rail Gate

DESCRIPTION	PART NO.
4' Width 4' High Classic 3 Rail Gate	891692
5' Width 4' High Classic 3 Rail Gate	891702
4' Width 5' High Classic 3 Rail Gate	891752
5' Width 5' High Classic 3 Rail Gate	891762
4' Width 6' High Classic 3 Rail Gate	891812
5' Width 6' High Classic 3 Rail Gate	891822

Two Walk Gates can be used to create a Drive Gate

Additional gate sizes and styles available call for more information

All product dimensions are nominal. For actual sizes contact Master Halco at:  
Ph# 1-888-289-3362

*Proudly Made in the U.S.A. From Recycled American Steel*



## Montage ATF<sup>™</sup> by Ameristar<sup>®</sup> MAJESTIC

An elegant flat top design that lends its appeal to a wide variety of applications.

- Adjusts up to 30" over 8' run to adapt for hills & slopes
- 20 year limited manufacturer warranty on panels
- Maintenance free ornamental fencing
- Proudly made in the U.S.A.



### Majestic 2 Rail Panel

DESCRIPTION	PART NO.
4' High (46" Net) Majestic 2 Rail Panel	890842
5' High (58" Net) Majestic 2 Rail Panel *	890852

\* Meets 1993 BOCA pool code standards Check Local codes for compliance.

### Majestic 2 Rail Gate

DESCRIPTION	PART NO.
4' Width 4' High Majestic 2 Rail Gate	894212
5' Width 4' High Majestic 2 Rail Gate	894222
4' Width 5' High Majestic 2 Rail Gate	894272
5' Width 5' High Majestic 2 Rail Gate	894282

### Majestic 2 Rail Flush Bottom Panel

DESCRIPTION	PART NO.
4' High (46-3/4" Net) Majestic 2 RailFlushBottom*	890872
5' High (58" Net) Majestic 2 Rail Flush Bottom*	890882

\* Meets 1993 BOCA pool code standards Check Local codes for compliance.

### Majestic 2 Rail Flush Bottom Gate

DESCRIPTION	PART NO.
4' Width 4' High Majestic 2 Rail Flush Btm Gate	894392
5' Width 4' High Majestic 2 Rail Flush Btm Gate	894402
4' Width 5' High Majestic 2 Rail Flush Btm Gate	894452
5' Width 5' High Majestic 2 Rail Flush Btm Gate	894462

### Majestic 3 Rail Panel

DESCRIPTION	PART NO.
4' High (46" Net) Majestic 3 Rail Panel	890902
5' High (58" Net) Majestic 3 Rail Panel *	890912
6' High (70" Net) Majestic 3 Rail Panel *	890922

\* Meets 1993 BOCA pool code standards Check Local codes for compliance.

All product dimensions are nominal. For actual sizes contact Master Halco at:  
Ph# 1-888-289-3362

### Majestic 3 Rail Gate

DESCRIPTION	PART NO.
4' Width 4' High Majestic 3 Rail Gate	894572
5' Width 4' High Majestic 3 Rail Gate	894582
4' Width 5' High Majestic 3 Rail Gate	894632
5' Width 5' High Majestic 3 Rail Gate	894642
4' Width 6' High Majestic 3 Rail Gate	894692
5' Width 6' High Majestic 3 Rail Gate	894702

Two Walk Gates can be used to create a Drive Gate

## Montage ATF<sup>™</sup> by Ameristar<sup>®</sup> GENESIS

An elegant picket design that lends its appeal to a wide variety of applications.

- Adjusts up to 30" over 8' run to adapt for hills & slopes
- 20 year limited manufacturer warranty on panels
- Maintenance free ornamental fencing
- Proudly made in the U.S.A.



### Genesis 2 Rail Panel

DESCRIPTION	PART NO.
4' High (46" Net) Genesis 2 Rail Panel	890482
5' High (58" Net) Genesis 2 Rail Panel *	890492

\* Meets 1993 BOCA pool code standards Check Local codes for compliance.

### Genesis 2 Rail Gate

DESCRIPTION	PART NO.
4' Width 4' High Genesis 2 Rail Gate	892772
4' Width 5' High Genesis 2 Rail Gate	892832

Actual gate dimensions vary from opening size listed above  
Two Walk Gates can be used to create a Drive Gate

### Genesis 3 Rail Panel

DESCRIPTION	PART NO.
4' High (46" Net) Genesis 3 Rail Panel	890542
5' High (58" Net) Genesis 3 Rail Panel	890552
6' High (70" Net) Genesis 3 Rail Panel *	890562

\* Meets 1993 BOCA pool code standards Check Local codes for compliance.

### Genesis 3 Rail Gate

DESCRIPTION	PART NO.
4' Width 4' High Genesis 3 Rail Gate	893132
5' Width 4' High Genesis 3 Rail Gate	893142
4' Width 5' High Genesis 3 Rail Gate	893192
5' Width 5' High Genesis 3 Rail Gate	893202
4' Width 6' High Genesis 3 Rail Gate	893252
5' Width 6' High Genesis 3 Rail Gate	893262

Two Walk Gates can be used to create a Drive Gate

All product dimensions are nominal. For actual sizes contact Master Halco at:  
Ph# 1-888-289-3362

Additional panel sizes and styles available call for more information

*Proudly Made in the U.S.A. From Recycled American Steel*

# MONTAGE<sup>®</sup> POST, BRACKETS & FINIALS

## Montage Panel Mounting Brackets

DESCRIPTION	PART NO.
2" Universal Bracket Montage (bag of qty 2)	420252
2" Line Bracket Montage (bag of qty 2)	902362
Flat Back Bracket Montage (bag of qty 2)	903862
Swivel Bracket Montage (bag of qty 2)	421932

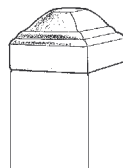

## Montage Post 2" Square

DESCRIPTION	PART NO.
57"H x 2" x 2" Post with Cap	420192
63"H x 2" x 2" Post with Cap	420202
69"H x 2" x 2" w/Cap (standard for 4' panels*)	443382
81"H x 2" x 2" w/Cap (standard for 5' panels*)	443402
93" H x 2" x 2" w/Cap (standard for 6' panels*)	443412
105" H x 2" x 2" Post with Cap	443432

\* Check Local codes for compliance Square Post Caps Included

## Post Cap

DESCRIPTION	PART NO.
2" Ball Post Cap Die Cast Aluminum	420332

## Post Base

DESCRIPTION	PART NO.
Post Base for Surface Mount	447982

## Finials

DESCRIPTION	PART NO.
Triad Finial 5/8" base (3-5/8" High) (Genesis Panels)	444392
Quad-Flair 5/8" base (3-5/8" High) (Genesis Panels)	444372
Double Ring for 4" Picket Spacing (11 per panel)	479102

## Touch-up Paint

DESCRIPTION	PART NO.
Cold Galvanized Primer (prime all cuts) 14 oz	012321
Touch-up Paint Black(13 oz. Spray)	447992

## Gate Hardware Set

DESCRIPTION	PART NO.
Single Walk Gate Set (2" Square Posts)	421902
Double Drive Gate Set (2" Square Posts)	421912

## Brackets

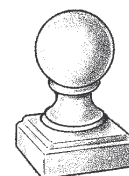
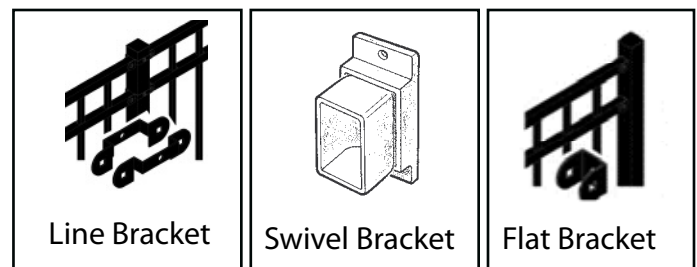
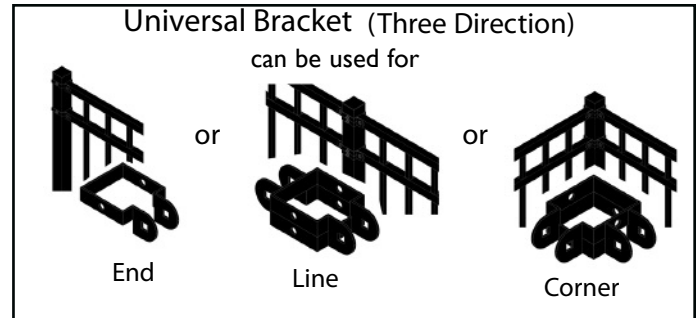

Ball Post Cap

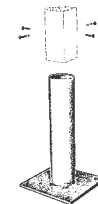

Post Base

## Finials

For 5/8" Pickets

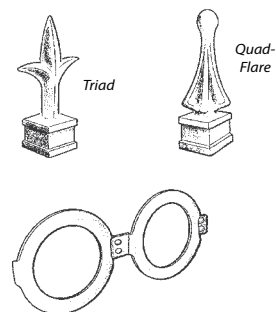

# GATE HINGE & LATCH SOLUTIONS



**TruClose® Hinge TCA1 # 044440**  
Hinge with Legs TCA1L2 # 448252

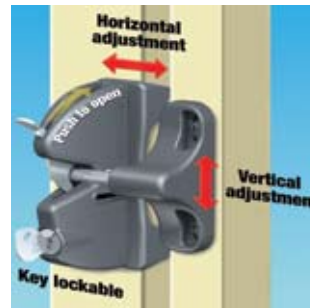

**LokkLatch® LLA A # 044473**



**TruClose® Mini-Multi Adjustable Hinge TCAMA2 # 036434**

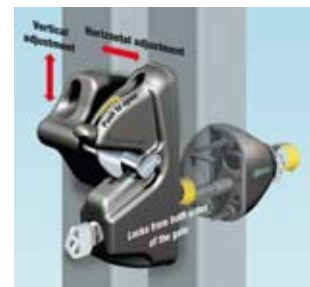

**LokkLatch® DELUXE LLDAB # 044487**

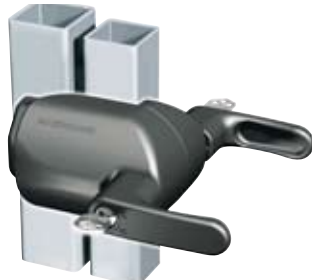

**Z-Lokk® ZL1 Magnetic dual-sided # 044448**



**MAGNALATCH® Side Pull # 044434**

## Drive Gate Drop Rod



**LokkBolt® LB1XXBX (18") # 198102 (24") # 198112**  
Optional Base Plate LBBPBG # 198162



Top Pull

Vertical Pull

**MAGNALATCH®**  
Top Pull #044430      Vertical Pull #044432

# ORNAMENTAL WALK & DRIVE GATES



## The Finest Ornamental Gates

Ornamental fences and gates have been the architectural choice for attractive security worldwide on public, commercial, industrial, and residential properties for hundreds of years. MasterHalco® offers custom made gates that add beauty and security to properties throughout the country. Combining modern technology with traditional elegance and craftsmanship, Master Halco is able to offer a unique, modern ornamental solution with the look of fencing forged by the hands of master blacksmiths.

## Special Order Double Swing Gates

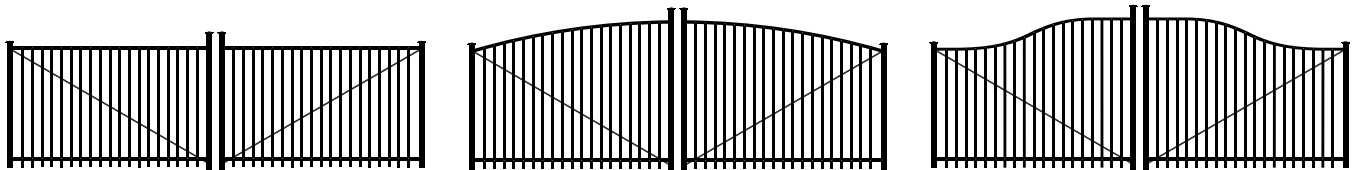

## Special Order Single Walk Gates

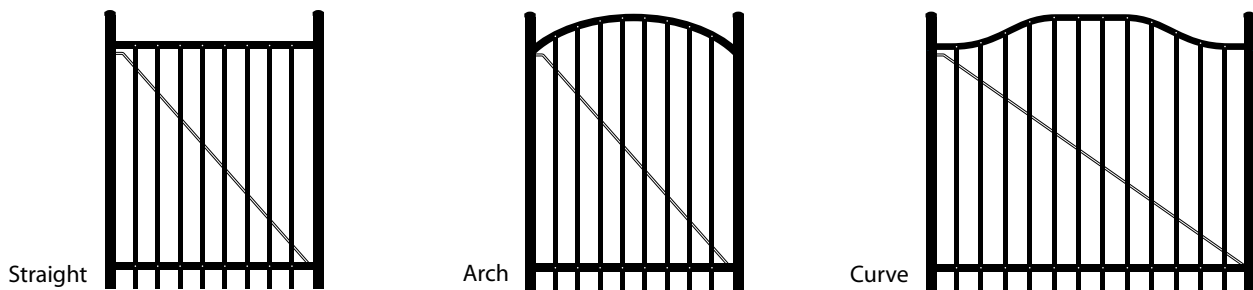

Orders on Custom Gates cannot be canceled. These Gates are manufactured to customer specifications and cannot be returned.

# VINYL FENCING PRODUCTS



Phone: 1-888-289-3362  
FAX: 1-800-542-8488  
MasterHalco.com



## What Makes Master Halco Vinyl Solutions Different?

All the profiles that go into the Illusions® line of vinyl fencing are made from extruders using advanced chemistry and state of the art proprietary tooling and manufacturing equipment. All of the polyvinyl components that go into our fence, deck, and railing systems are constructed of scientifically formulated 100% virgin co-extruded vinyl compounds. There are no reprocessed fillers added to weaken or compromise color and structural stability.

Illusions® brand vinyl fencing uses top-grade materials from the nations leading extruders of vinyl products. The materials are a custom blended mix of stabilizers, impact modifiers, processing aids and pigments. Long term weathering studies have shown these products tin stabilized, acrylate modified formulations with high levels of titanium dioxide (a pigment and UV light screener) result in the best retention of color, gloss and toughness.

Our PVC has the industry leading standard of 10 parts per 100 TiO<sub>2</sub> (titanium dioxide) to give its vinyl the longevity and performance of a lifetime product.



# VINYL FENCING PRODUCTS



Phone: 1-888-289-3362

FAX: 1-800-542-8488

MasterHalco.com

Master Halco is dedicated to supplying a comprehensive and high-quality line of vinyl products that provide solutions. The Illusions product offering fulfills those needs, and offers the following features & benefits:

- Pre-Assembled Panels
- Save Time & Labor Costs
- High Quality Construction
- Superior Packaging



456254 4' Straight Victorian - White



456004 6' Privacy - White



456354 4' Contemporary Picket - White



456008 6' Privacy - Beige



456324 4' Scalloped Victorian - White

Product assortment varies by location. Check with your branch for product availability

# NEW PRODUCTS

## Temporary Fence Panels Construction Site

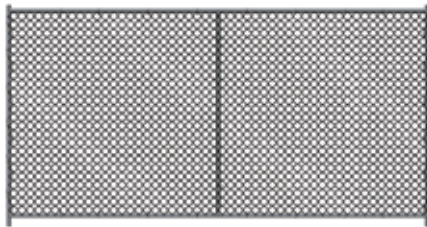

## TEMPORARY FENCE PANELS Laced

DESCRIPTION	PART NO.
10'W x 6'H - 2 <sup>3</sup> / <sub>8</sub> " x 12.5 Gauge	071070
10'W x 6'H - 2 <sup>3</sup> / <sub>8</sub> " x 11.5 Gauge	071075
10'W x 6'H - 2 <sup>3</sup> / <sub>8</sub> " x 11.5 Gauge Dual Cross Rods	071079
12'W x 6'H - 2 <sup>3</sup> / <sub>8</sub> " x 12.5 Gauge	071071
12'W x 6'H - 2 <sup>3</sup> / <sub>8</sub> " x 11.5 Gauge	071076
12'W x 6'H - 2 <sup>3</sup> / <sub>8</sub> " x 11.5 Gauge Dual Cross Rods	071080



## PANEL STANDS

DESCRIPTION	PART NO.
Panel Stand - 16Ga Tube	071074
Panel Stand - 16Ga Tube with <sup>3</sup> / <sub>4</sub> " Rebar	071060



## POSTMASTER STEEL POST

DESCRIPTION	PART NO.
7'-6" PostMaster Steel Post	633663
8' PostMaster Steel Post	633664
9' PostMaster Steel Post	633666
10' PostMaster Steel Post	633668

## Gate Kits for Wood & PVC

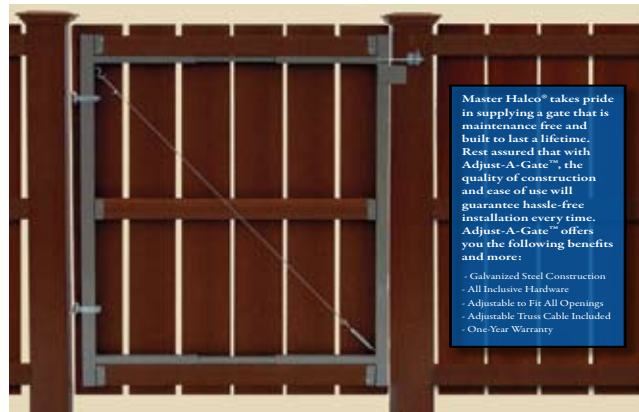

Master Halco® takes pride in supplying a gate that is maintenance free and built to last a lifetime. Rest assured that with Adjust-A-Gate™, the quality of construction and ease of use will guarantee hassle-free installation every time. Adjust-A-Gate™ offers you the following benefits and more:

- Galvanized Steel Construction
- All Inclusive Hardware
- Adjustable to Fit All Openings
- Adjustable Tension Cable Included
- One-Year Warranty

Wood and PVC Gate Solutions Featuring

**ADJUST-A-GATE™**

## ADJUST-A-GATE for Wood & Vinyl

DESCRIPTION	PART NO.
Wood Gate Kit Fits 36"-60" W (4' or 5' H)	049904
Wood Gate Kit Fits 36"-60" W (6' or Taller)	049901
Wood Gate Kit Fits 60"-96" W 4' or 5' H	049905
Wood Gate Kit Fits 60"-96" W (6' or Taller)	049902
Vinyl Gate Kit Fits 2 Rail Style	457784
Vinyl Gate Kit Fits 3 Rail Style	457794
Vinyl Gate Kit Fits 4 Rail Style	457804
Vinyl Gate Drop Rod Kit	457844



# NEW PRODUCTS



## DESIGNMASTER Welded Wire Panels

DESCRIPTION	PART NO.
<b>4' High Panels</b>	
4'H x 8'W Panel Green	519121
4'H x 8'W Panel Black	519122
<b>6' High Panels</b>	
6'H x 8'W Panel Green	518901
6'H x 8'W Panel Black	518902
<b>8' High Panels</b>	
8'H x 8'W Panel Green	518971
8'H x 8'W Panel Black	518972

Specifications: 6 gauge wire, galvanized class 1 & powder coated, 2"x6" squares

## DESIGNMASTER POSTS

DESCRIPTION	PART NO.
6' High DesignMaster Square Post - Green	518911
6' High DesignMaster Square Post - Black	518912
8' High DesignMaster Square Post - Green	518921
8' High DesignMaster Square Post - Black	518922
11' High DesignMaster Square Post - Green	518981
11' High DesignMaster Square Post - Black	518982

\*Also available in additional colors.



## DESIGNMASTER Brackets & Base Plates

DESCRIPTION	PART NO.
Green Brackets ( Each )	002960
Black Brackets ( Each )	002961
Green Steel Base Plate	518941
Black Steel Base Plate	518942

## DESIGNMASTER Walk Gates

DESCRIPTION	PART NO.
<b>6' High Walk Gates</b>	
48" W x 6'H Single Walk Gate Green	518951
48" W x 6'H Single Walk Gate Black	518952
<b>8' High Walk Gates</b>	
48" W x 8'H Single Walk Gate Green	518991
48" W x 8'H Single Walk Gate Black	518992

\*Also available in other sizes

## DESIGNMASTER Double Drive Gates

DESCRIPTION	PART NO.
<b>6' High Drive Gates</b>	
12' W x 6'H Double Drive Gate Green	519011
12' W x 6'H Double Drive Gate Black	519012
<b>8' High Drive Gates</b>	
12' W x 8'H Double Drive Gate Green	519021
12' W x 8'H Double Drive Gate Black	519022



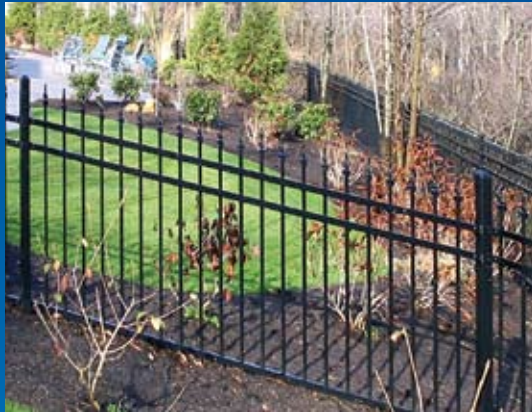

## For all your fencing needs, you can trust **MASTER HALCO.**

As North America's leading manufacturer and wholesale distributor of perimeter security and fencing, we are the provider of choice for thousands of professional fence and security contractors and quality building material retailers. Since 1961, we have been the industries' premier fencing provider.

We offer a complete line of high quality fence systems in both traditional and unique styles. Our full line of products include vinyl, wood, ornamental, welded wire and chain-link fences and gates for residential, commercial, industrial, and high security applications.



*Chain-link  
Ornamental  
Wood  
Vinyl*

**MasterHalco.com**  
**Phone: 1-888-MH-Fence**  
**Phone: 1-888-289-3362**  
**FAX: 1-800-542-8488**