



architectural doors & gates



**covrit**.com



## Anatomy of a **covrit** Gate

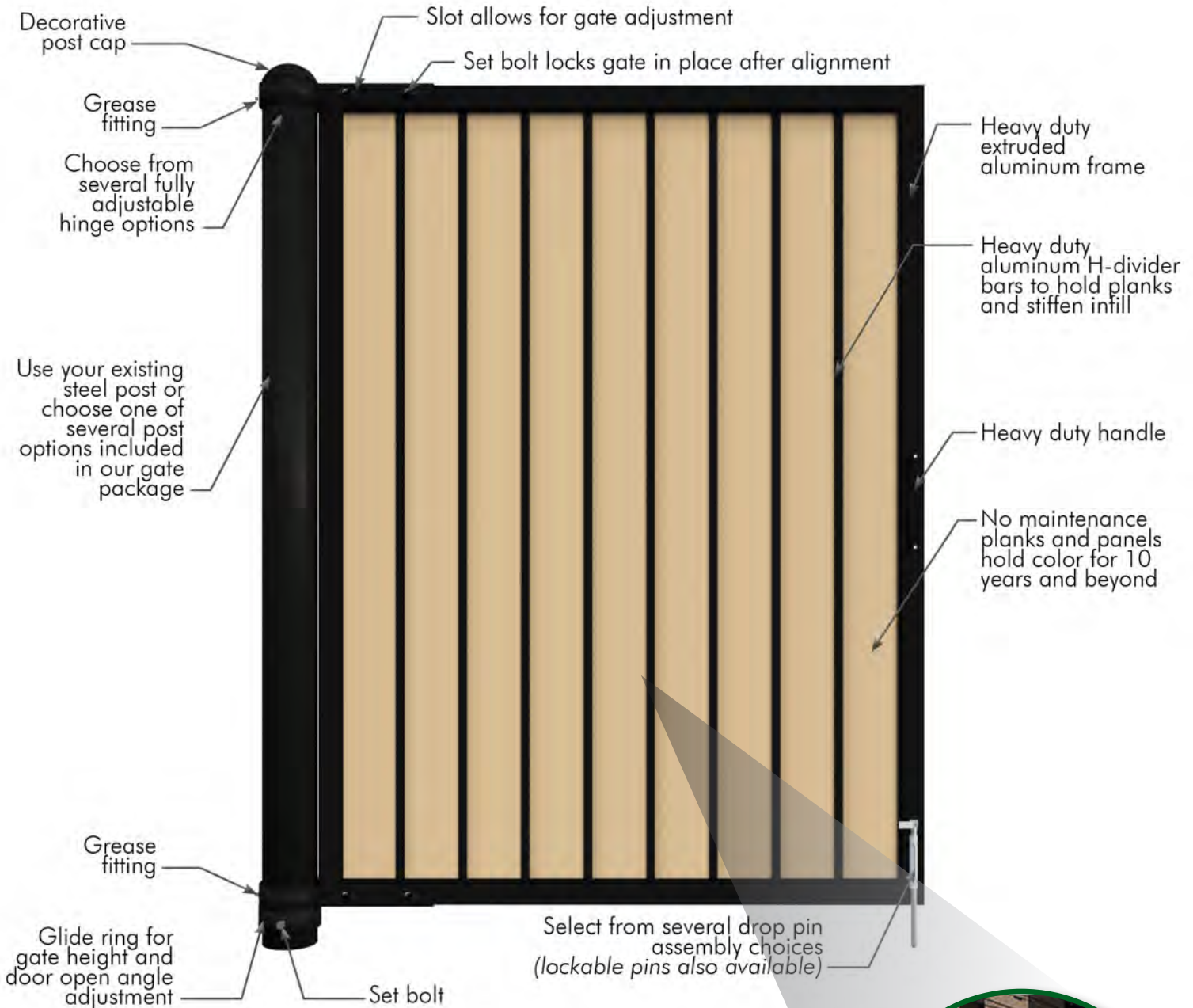

- **Improve Your Image** by impressing upon your customers that you pay attention to detail.
- **Buy Covrit Replacement Doors!** Sagging, broken, rotted and aging dumpster doors are proven to negatively affect traffic and sales by 10% or more.
- **Covrit Professional Grade Aluminum Doors** are built to last many years beyond wooden and galvanized doors.
- **Significantly Reduces Maintenance Costs** by using easily replaceable components.



## Adjustable Pipe Hinge

### preferred mounting method

- adjustable cradle hinge design
- welded steel hinge provides years of trouble free operation
- no field welding required
- standard grade fittings
- 2 component urethane finish
- standard on all Covrit gates or retrofits where possible
- steel posts available from Covrit or local steel supplier

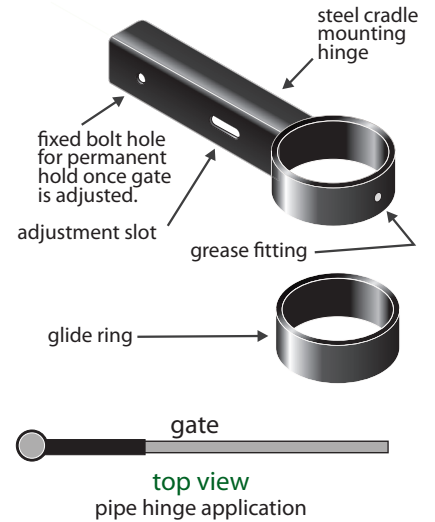
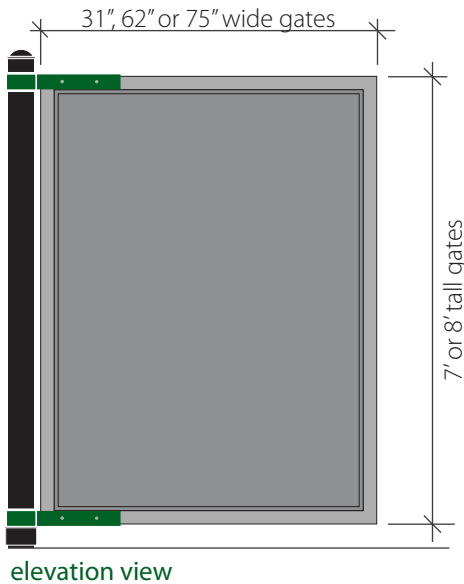

*"This is the best hinge design I have ever seen"*

Gary Fisher, Facilities Manager

## Barrel Hinge

### acceptable mounting method

- 3/4" pin w / ball bearing for smooth operation
- adjustable steel plate mounts hinge to gate frame
- field welding required to mount hinge to post

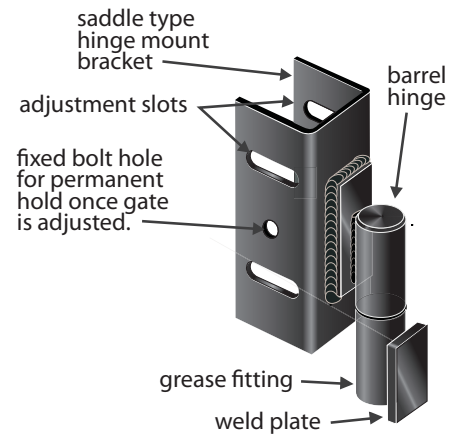
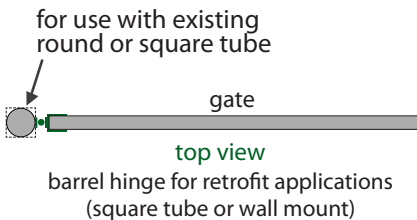

## Plate Hinge

### acceptable mounting method

- 3/8" pin for smooth operation
- positionable steel plate mounts hinge to gate frame
- field welding required to mount hinge to post

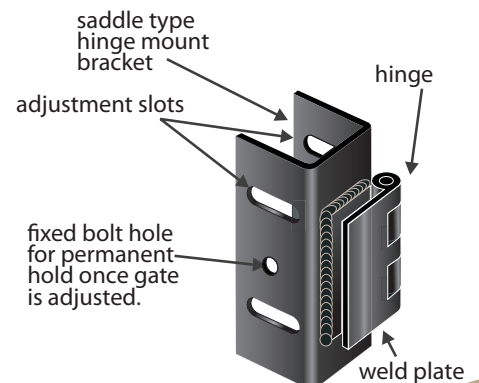
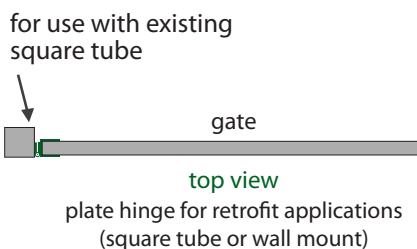

## Park Collection

The Park Collection of gates are built using a professional grade aluminum framework with heavy duty aluminum tube cross members. The fill areas can be either natural wood or PVC wood grain plank material. Our designers can help you choose a combination that works for you.

a. Augusta style

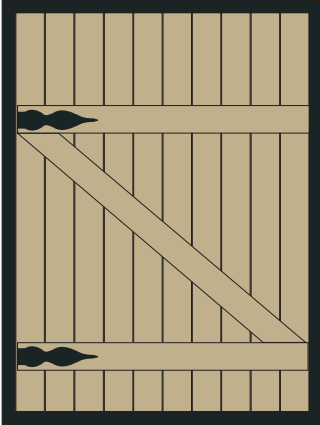

example 1

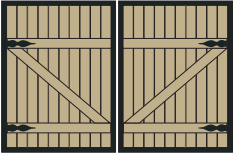

b. Madison style

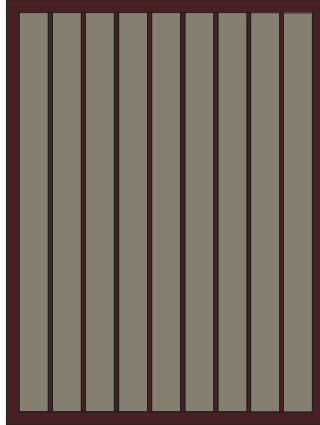

example 1

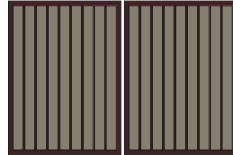

c. Mission style



example 1

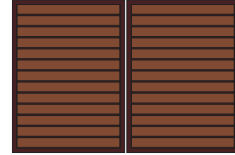

d. Sequoia style



example 1

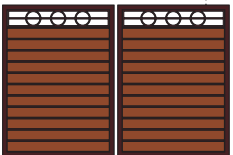

e. Muir Woods style

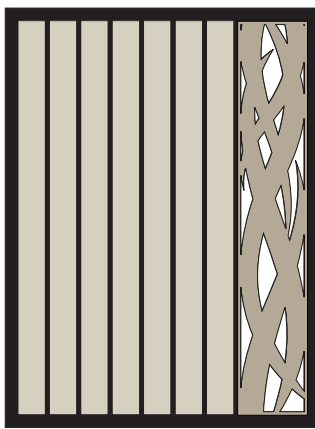

example 1



f. Redondo style



example 1

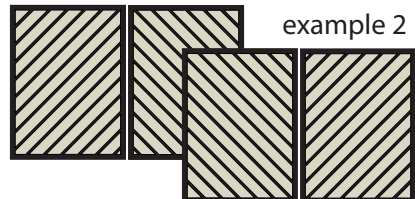

## Innova Collection

The Innova Collection of gates are also constructed from the same professional grade aluminum framework and heavy duty aluminum tube cross members with long-lasting PVC material infill.

a. Canby style



example 1

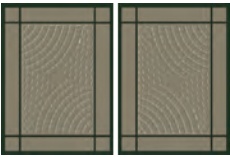

b. Flagstaff style

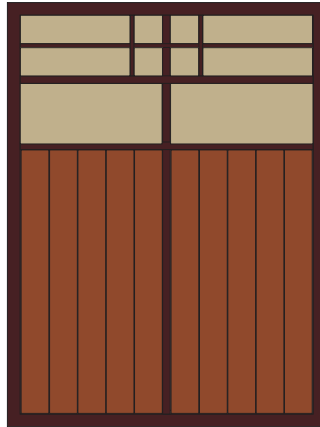

example 1

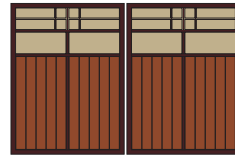

c. Avon style



example 1



d. Richland style

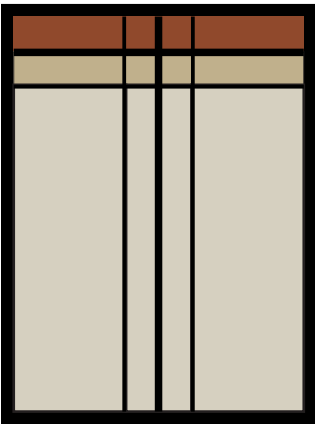

example 1

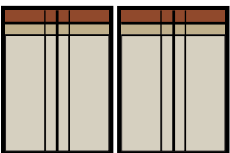

e. Potomac style



example 1

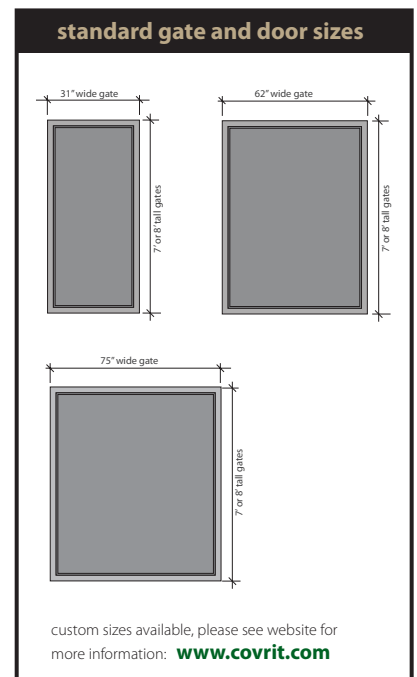

## Panel Colors\*

This durable, all weather PVC material is used in many of the CityScapes product lines, from equipment screen panels to gate filler panels. We offer a variety of colors to complement any environment.



## Plank Colors\*

Our PlankWall material is manufactured from enhanced PVC plank. It's used for gate and gate filler panels, as well as an alternative to the ABS panels. The color runs all the way through this material so scratches are virtually undetectable! Planks are also fade and stain-resistant. We offer single and double-sided wood grain planks to suit any project need.

single-sided wood grain



double-sided wood grain



## Natural Wood\*

If real wood is in your plans, we start with only the highest grade raw lumber and mill it to fit our gates and doors. We can stain and/or clear coat it to hold the natural beauty, or let it weather naturally. Your call!



## Frame Paint Colors

We use only the highest quality 2-component urethane enamels for finishing the aluminum wall, gate frame and steel hinges. These colors represent a small sampling of the most popular colors. We can match any color to fit your project specifications.

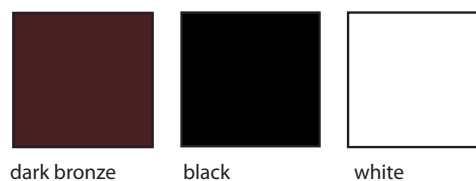

---

**covrit** Architectural Doors and Gates provide a complete and elegant solution to an often neglected segment of commercial architecture. Our diverse selection of gate and door styles solves the dilemma of hiding all types of building maintenance and service areas including loading docks, dumpster surrounds, recycle containers, electrical transformers, utility meters, maintenance vehicle areas, storage areas, swimming pool pumps and heaters, portable restrooms and propane tanks. The Covrit family of screening products offer unlimited flexibility in enhancing the overall appearance of your project design.

**covrit** Doors and Gates offer:

- **Stylish Design** to enhance your overall project
- **Modular Construction** for superior adaptability to your facility screening requirements
- **Green Friendly Components** provide all the advantages of using 100% recyclable materials in over 95% of the entire project
- **No On-Site Welding or Masonary Trades** required for installation
- **Readily Available Replacement Parts** ensure quick and easy repairs
- **Professional Grade Quality and Service** with every order

Check out the Covrit Dumpster Enclosures catalog - the perfect complement to our gates and doors, as well as the entire line of screening products brought to you by CityScapes, Inc. at [www.cityscapesinc.com](http://www.cityscapesinc.com), the maker of the famous Envisor™ Rooftop Equipment Screens.

Our team of skilled engineers are committed to providing you with all the technical support and drawings necessary to achieve your goals.





architectural  
doors & gates

**covrit** is an affordable and durable solution for screening building maintenance and service areas. Available in multiple panel designs, sizes and colors, Covrit Doors & Gates are sure to complement any project.

**covrit** systems are packaged and shipped directly to the site for easy assembly.

CityScapes can also provide turnkey installation to complete the project.

Our team of skilled engineers are committed to providing you with all the technical support and drawings necessary to achieve your goals.

Contact us today!

 **cityscapes**  
architectural innovations  
4200 Lyman Court, Hilliard, OH 43026  
p. 877.SCREENS • f. 800.726.4817  
[www.cityscapesinc.com](http://www.cityscapesinc.com)

