

Floor Boxes That Restore & Maintain Floor Fire Ratings

Legrand® takes Wiremold floor boxes to the next level with the introduction of seven recessed and flush style floor box models that meet or exceed UL Fire Classification requirements. Available in both single- and multiple-gang versions, in both steel and nonmetallic fabrications, these floor boxes preserve the two-hour fire rating of floors in which they have been installed and are a favored industry solution for getting power, communication, and audio video services into open spaces. These new boxes also accept existing cover plate and service fitting offerings.

When properly installed, Fire Classified Floor Boxes save time and money for general contractors and installers by eliminating the need for spraying to fireproof floors. They also eliminate the guesswork for inspectors and provide reassurance for building owners and property managers by meeting or exceeding the UL Fire Classification Standards for Floor Boxes.

The new Fire Classified Floor Boxes maintain a two-hour fire rating and are available in both flush and recessed configurations.



FEATURES & BENEFITS

- **Maintains fire classification of fire rated floors.** Fire rated floor boxes preserve up to a two-hour fire rating for floors in which they are installed. Eliminates the need to install additional fireproofing to underfloor surfaces to restore the floor's fire rating.
- **UL Listed and UL Fire Classified to U.S. and Canadian safety standards for tile and terrazzo.** Standard fire rating provides peace of mind for building owners, general contractors, installers, and inspectors that building floors will meet safety guidelines for occupants. Includes the UL requirements under UL514A and UL 514C for the scrub water exclusions test for carpet, tile and wood floors and UL263 for fire rating.
- **Fully adjustable boxes.** Each floor box model is adjustable both before and after the concrete pour. Adjustability reduces installation errors and reduces labor and installation costs by adapting to various pour depths and conditions.
- **Triple service.** Accommodates power, communication and/or audio/video devices reducing the need for multiple boxes.
- **Provide more services to open space environments.** Fire rated floor boxes provide multiple service and capacity options and can be installed 2 feet on center for increased accessibility to services for occupants.
- **Available in one-, two-, three-, and four-gang versions in both flush and recessed models.** Dividers can be removed in several models for greater capacity and to provide multiple configuration options for multi-service installations.
- **Accepts existing covers.** Allows for a consistent aesthetic finish. Reduces the need to learn a new set of cover options.
- **TopGuard Protection.** Integral design components that prevents water, dirt and debris from entering power and communication compartments. Whenever you see the TopGuard protection icon on any Wiremold product, you'll know it meets and exceeds UL scrub water exclusion requirements for tile, wood covered, polished concrete, terrazzo and carpet floors.
- **Communication connectivity options.** Accepts industry standard and proprietary devices from a wide range of manufacturers to provide a seamless and aesthetically pleasing interface for voice, data, audio, and video applications at the point-of-use. A wide selection of data and adapter options are available for use with Ortronics® TracJack and Series II devices.



Protection from water, dirt, and debris.

Fire Classified Standard Depth Steel OmniBox Floor Box Ordering Information

Item	Catalog No./Description/Specifications
<p>8801S-FC</p>	<p>One-Gang Fire Classified Steel Floor Box – Adjustment range over deck of 2" [51mm] minimum to 5" [127mm] maximum. One 1 1/4" [32mm] conduit feed opening. Box Capacity - 53 cubic inches.</p> <p>Country of Origin: USA</p> <p>NOTE: Floor Box spacing 2' on center and one for every 4 square feet in a span. Four (4) #12 AWG Type THHN Power Conductors or 48 #23 AWG (6 Cat. 6) Tele Data Conductors per gang.</p>
<p>8802S-FC</p>	<p>Two-Gang Fire Classified Steel Floor Box – Adjustment range over deck of 2" [51mm] minimum to 5" [127mm] maximum. Two 1 1/4" [32mm] conduit feed openings. Box Capacity - 58.5 cubic inches each gang.</p> <p>Country of Origin: USA</p> <p>NOTE: Floor Box spacing 2' on center and one for every 4 square feet in a span. Four (4) #12 AWG Type THHN Power Conductors or 48 #23 AWG (6 Cat. 6) Tele Data Conductors per gang.</p>
<p>8803S-FC</p>	<p>Three-Gang Fire Classified Steel Floor Box – Adjustment range over deck of 2" [51mm] minimum to 5" [127mm] maximum. Three 1 1/4" [32mm] conduit feed openings. Inside Gang Capacity - 67.5 cubic inches. Outside Gang Capacity - 54 cubic inches each gang.</p> <p>Country of Origin: USA</p> <p>NOTE: Floor Box spacing 2' on center and one for every 4 square feet in a span. Four (4) #12 AWG Type THHN Power Conductors or 48 #23 AWG (6 Cat. 6) Tele Data Conductors per gang.</p>

OmniBox Series Floor Boxes Solid Brass Cover Plate Flanges Ordering Information

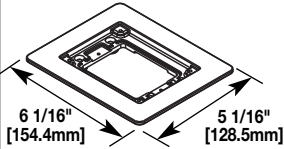
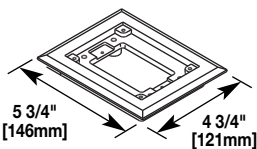
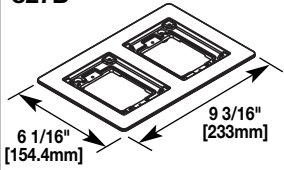
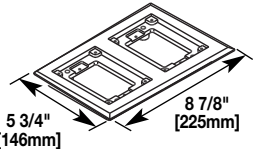
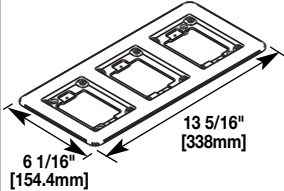
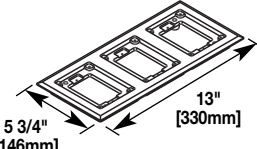
Catalog No./Item	Description/Specifications	Catalog No./Item	Description/Specifications
817B	 <p>One-Gang Brass Combination Carpet & Tile Flange – Accepts Ortronics® MAB6TJ TracJack and MAB3S2 Series II adapters and Wiremold CM Series inserts, sold separately.</p> <p>Country of Origin: China</p>	817C	 <p>One-Gang Brass Carpet Flange – For use on 880S1, 880M1, 880CS1-1, and 880CM1-1 Floor Boxes.</p> <p>Country of Origin: China</p>
827B	 <p>Two-Gang Brass Combination Carpet and Tile Flange – Accepts Ortronics® MAB6TJ TracJack and MAB3S2 Series II adapters and Wiremold CM Series inserts, sold separately.</p> <p>Country of Origin: China</p>	827C	 <p>Two-Gang Brass Carpet Flange – For use on 880S2, 880M2, 880CS2-1, and 880CM2-1 Floor Boxes.</p> <p>Country of Origin: China</p>
837B	 <p>Three-Gang Brass Combination Carpet and Tile Flange – Accepts Ortronics® MAB6TJ TracJack and MAB3S2 Series II adapters and Wiremold CM Series inserts, sold separately.</p> <p>Country of Origin: China</p>	837C	 <p>Three-Gang Brass Carpet Flange – For use on 880S3, 880M3, 880CS32-1, and 880CM3-1 Floor Boxes.</p> <p>Country of Origin: China</p>

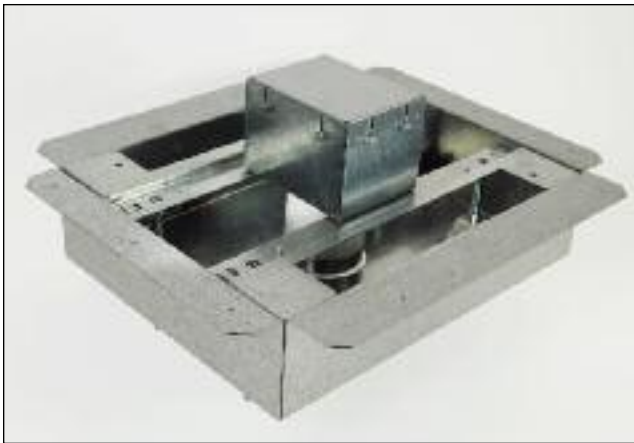

Fire-Classified
OmniBox Series
Floor Box

NOTE: UL Listed for tile, terrazzo, polished concrete, wood, and carpet floors.

Brass covers and flanges are not interchangeable with aluminum or nonmetallic covers and flanges. Nonmetallic covers are interchangeable with aluminum flanges.

All cover assemblies for the OmniBox Series Floor Box have TopGuard protection.

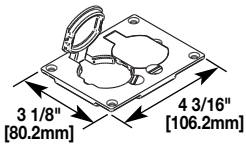
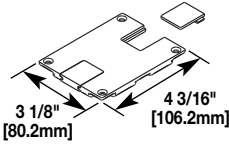
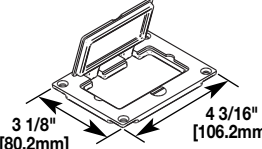
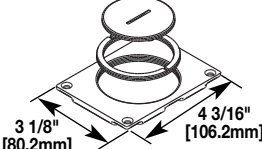
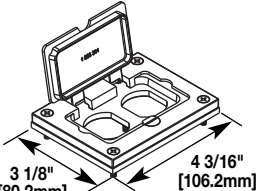
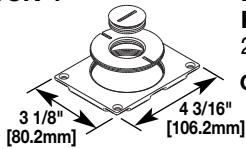
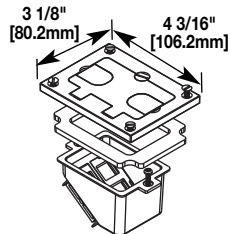
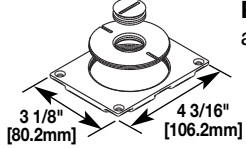
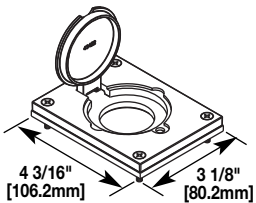
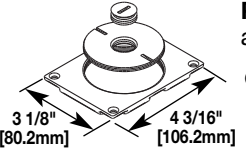
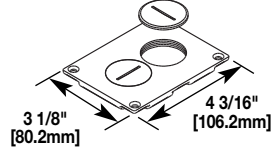
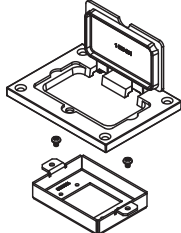

OmniBox Series Floor Boxes Metal Cover Plates Ordering Information

Catalog No./Item	Description/Specifications	Catalog No./Item	Description/Specifications
828R 	Brass Duplex Cover Plate – Flip lids. Can also be used with a 106 type communication adapter. Country of Origin: China	829STC 	Brass Communication Cover Plate – Data slides. Feed through only, not for use with a mounting plate for communication jacks. Country of Origin: China
828GFITC 	Brass GFI Cover Plate – May be used with Activate and Ortronics® Connectivity Systems in conjunction with 817B, 827B, and 837B Flanges. Country of Origin: China	829CK 	Brass Communication Cover Plate – 2 5/8" and 2 1/4" [67mm and 57mm] plugs. Country of Origin: China
828DPGFITC 	Brass Rectangular Cover Plate – Allows for mounting of a duplex style receptacle with a rectangular style flip lid cover. Country of Origin: China	829CK-1 	Brass Communication Cover Plate – 2 5/8" and 1" [67mm and 25mm] plugs. Country of Origin: China
828COMTC 	Brass Communication Cover Plate – Allows for up to four communication devices to be mounted in a recessed position within the 880 Floor Box. The 828COM Cover Plate has removable slides for cable egress. Country of Origin: China NOTE: For use with 880S and 880CS Series Boxes only.	829CK-3/4 	Brass Communication Cover Plate – 2 5/8" and 3/4" [67mm and 19.1mm] plugs. Country of Origin: China
828DLR 	Brass Single Locking Receptacle Cover Plate – Single flip lid cover for 20A or 30A single locking receptacles. Device opening is 2 5/8" [67mm]. For use with maximum female locking device of 1.58" diameter, and maximum male plug face of 2.25" diameter Country of Origin: China	829CK-1/2 	Brass Communication Cover Plate – 2 5/8" and 1/2" [67mm and 12.7mm] plugs. Country of Origin: China
828SPTC 	Brass Duplex Cover Plate – Screw plugs. Screw plugs are 1 1/2" [38mm] in diameter. Country of Origin: China	828MAAP 	A/V Adapter Plate – Sheet metal adapter plate that accepts two (2) Extron® Electronics MAAP style device plates (sold separately). For use with 828GFITC or 828GFITCAL cover plates. (Sold separately). Country of Origin: USA

NOTE: UL Listed for tile, terrazzo, polished concrete, wood and carpet floors.

Brass covers and flanges are not interchangeable with aluminum or nonmetallic covers and flanges. Nonmetallic covers are interchangeable with aluminum flanges.

All cover assemblies for the OmniBox Series Floor Box have TopGuard protection.

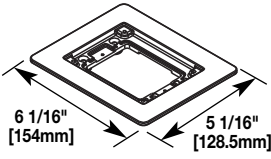
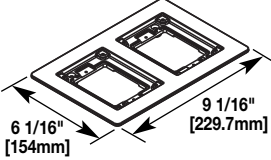
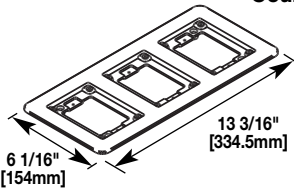

OmniBox Series Floor Boxes Brushed Aluminum Cover Plate Flanges Ordering Information

Catalog No./Item	Description/Specifications
<p>818TCAL</p>  <p>6 1/16" [154mm] 5 1/16" [128.5mm]</p>	<p>One-Gang Brushed Aluminum Combination Carpet and Tile Flange – Accepts Ortronics® MAB6TJ TracJack and MAB3S2 Series II adapters and Wiremold CM Series inserts, sold separately.</p> <p>Country of Origin: China</p> <p>NOTE: Brushed aluminum flanges come with beveled edges.</p>
<p>828TCAL</p>  <p>6 1/16" [154mm] 9 1/16" [229.7mm]</p>	<p>Two-Gang Brushed Aluminum Combination Carpet and Tile Flange – Accepts Ortronics® MAB6TJ TracJack and MAB3S2 Series II adapters and Wiremold CM Series inserts, sold separately.</p> <p>Country of Origin: China</p> <p>NOTE: Brushed aluminum flanges come with beveled edges.</p>
	<p>838TCAL</p> <p>Three-Gang Brushed Aluminum Combination Carpet and Tile Flange – Accepts Ortronics® MAB6TJ TracJack and MAB3S2 Series II adapters and Wiremold CM Series inserts, sold separately.</p> <p>Country of Origin: China</p>  <p>6 1/16" [154mm] 13 3/16" [334.5mm]</p> <p>NOTE: Brushed aluminum flanges come with beveled edges.</p>

NOTE: UL Listed for tile, terrazzo, polished concrete, wood and carpet floors.

Brass covers and flanges are not interchangeable with aluminum or nonmetallic covers and flanges. Nonmetallic covers are interchangeable with aluminum flanges.

All cover assemblies for the OmniBox Series Floor Box have TopGuard protection.

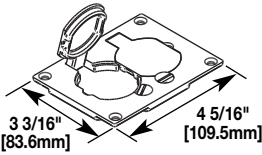
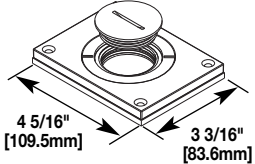
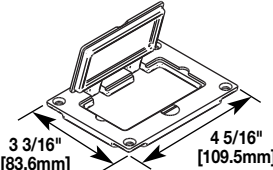
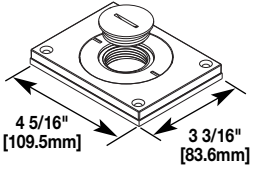
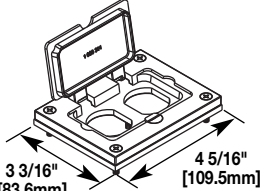
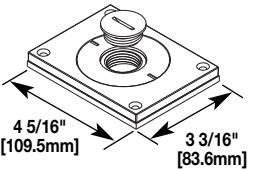
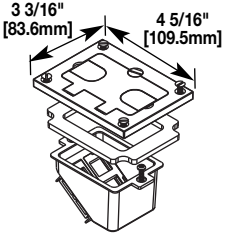
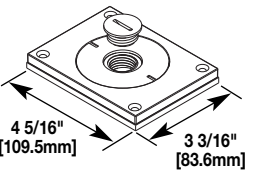
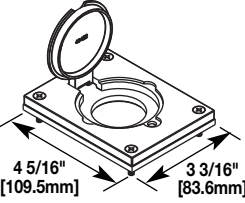
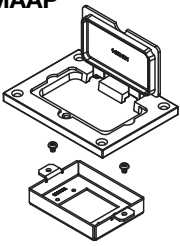

OmniBox Series Floor Boxes Metal Cover Plates Ordering Information

Catalog No./Item	Description/Specifications	Catalog No./Item	Description/Specifications
828R-TCAL 	Brushed Aluminum Duplex Cover Plate – Flip lids. Can also be used with a 106 type communication adapter. Country of Origin: China	830CKTCAL 	Brushed Aluminum Cover Plate – Power or communication plate with 2" [51mm] and 1 1/4" [32mm] plugs. Country of Origin: China NOTE: Acceptable for use with threaded conduit when passing through power cables.
828GFITCAL 	Brushed Aluminum GFI Cover Plate – May be used with Activate and Ortronics® Connectivity Systems in conjunction with 817B, 827B, and 837B Flanges. Country of Origin: China	830CKTCAL-1 	Brushed Aluminum Cover Plate – Power or communication plate with 2" [51mm] and 1" [25mm] plugs. Country of Origin: China NOTE: Acceptable for use with threaded conduit when passing through power cables.
828DPGFITCAL 	Brushed Aluminum Rectangular Cover Plate – Allows for mounting of a duplex style receptacle with a rectangular style flip lid cover. Country of Origin: China	830CKTCAL-3/4 	Brushed Aluminum Cover Plate – Power or communication plate with 2" [51mm] and 3/4" [19.1mm] plugs. Country of Origin: China NOTE: Acceptable for use with threaded conduit when passing through power cables.
828COMTCAL 	Brushed Aluminum Communication Cover Plate – Allows for up to four communication devices to be mounted in a recessed position within the 880 Floor Box. The 828COMTCAL Cover Plate has removable slides for cable egress. Country of Origin: China NOTE: For use with 880S and 880CS Series Boxes only.	830CKTCAL-1/2 	Brushed Aluminum Cover Plate – Power or communication plate with 2" [51mm] and 1/2" [12.7mm] plugs. Country of Origin: China NOTE: Acceptable for use with threaded conduit when passing through power cables.
828DLRAL 	Brushed Aluminum Single Locking Receptacle Cover Plate – Single flip lid cover for 20A or 30A single locking receptacles. Device opening is 2 5/8" [67mm]. For use with maximum female locking device of 1.58" diameter, and maximum male plug face of 2.25" diameter Country of Origin: China	828MAAP 	A/V Adapter Plate – Sheet metal adapter plate that accepts two (2) Legrand AVIP device plates or Extron® Electronics MAAP style device plates (sold separately). For use with 828GFITC or 828GFITCAL cover plates. (Sold separately.) Country of Origin: USA

NOTE: UL Listed for tile, terrazzo, polished concrete, wood and carpet floors.

Brass covers and flanges are not interchangeable with aluminum or nonmetallic covers and flanges. Nonmetallic covers are interchangeable with aluminum flanges.

All cover assemblies for the OmniBox Series Floor Box have TopGuard protection.

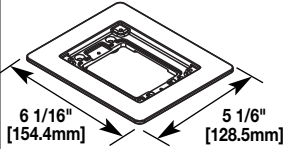
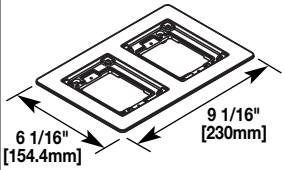
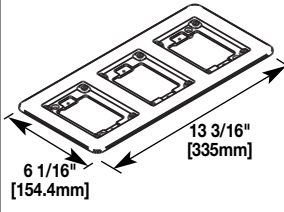
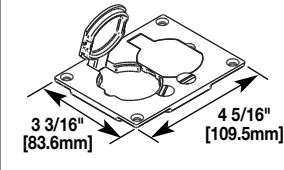
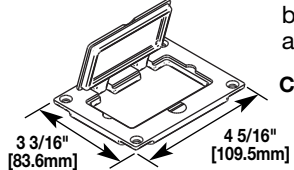
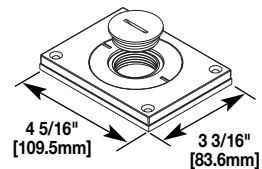
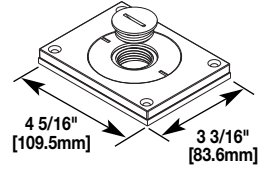
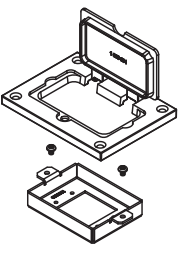

OmniBox Series Floor Boxes Powder-Coated Aluminum Cover Plate Flanges Ordering Information

Catalog No./Item	Description/Specifications
<p>817TCAL-BK 817TCAL-GY 817TCAL-BS 817TCAL-NK 817TCAL-BZ</p>  <p style="text-align: center;">Country of Origin: USA</p>	<p>One-Gang Powder-Coated Aluminum Combination Carpet and Tile Flange – Accepts Ortronics® MAB6TJ TracJack and MAB3S2 Series II adapters and Wiremold CM Series inserts, sold separately. Flanges are available in five decorative colors: black, gray, brass, nickel and bronze.</p> <p style="text-align: center;">Country of Origin: USA</p>
<p>827TCAL-BK 827TCAL-GY 827TCAL-BS 827TCAL-NK 827TCAL-BZ</p>  <p style="text-align: center;">Country of Origin: USA</p>	<p>Two-Gang Powder-Coated Aluminum Combination Carpet and Tile Flange – Accepts Ortronics® MAB6TJ TracJack and MAB3S2 Series II adapters and Wiremold CM Series inserts, sold separately. Flanges are available in five decorative colors: black, gray, brass, nickel and bronze.</p> <p style="text-align: center;">Country of Origin: USA</p>
<p>837TCAL-BK 837TCAL-GY 837TCAL-BS 837TCAL-NK 837TCAL-BZ</p>  <p style="text-align: center;">Country of Origin: USA</p>	<p>Three-Gang Powder-Coated Aluminum Combination Carpet and Tile Flange – Accepts Ortronics® MAB6TJ TracJack and MAB3S2 Series II adapters and Wiremold CM Series inserts, sold separately. Flanges are available in five decorative colors: black, gray, brass, nickel and bronze.</p> <p style="text-align: center;">Country of Origin: USA</p>
<p>828R-TCAL-BK 828R-TCAL-GY 828R-TCAL-BS 828R-TCAL-NK 828R-TCAL-BZ</p>  <p style="text-align: center;">Country of Origin: USA</p>	<p>Powder-Coated Aluminum Duplex Cover Plate – Flip lids. Can also be used with a 106 type communication adapter.</p> <p style="text-align: center;">Country of Origin: USA</p>
<p>828GFITCAL-BK 828GFITCAL-GY 828GFITCAL-BS 828GFITCAL-NK 828GFITCAL-BZ</p>  <p style="text-align: center;">Country of Origin: USA</p>	<p>Powder-Coated Aluminum Rectangular Cover Plate – Allows for mounting a duplex receptacle (Decorator or GFCI style) with a rectangular flip cover. Covers are available in five decorative colors: black, gray, brass, nickel and bronze.</p> <p style="text-align: center;">Country of Origin: USA</p>
<p>829CKAL-1BK 829CKAL-1GY 829CKAL-1BS 829CKAL-1NK 829CKAL-1BZ</p>  <p style="text-align: center;">Country of Origin: USA</p>	<p>Powder-Coated Aluminum Cover Plate – Power or communication plate with 2" [51mm] and 1" [25mm] plugs. Covers are available in five decorative colors: black, gray, brass, nickel and bronze.</p> <p style="text-align: center;">Country of Origin: USA</p> <p>NOTE: Acceptable for use with threaded conduit when passing through power cables.</p>
<p>829CKAL-3/4BK 829CKAL-3/4GY 829CKAL-3/4BS 829CKAL-3/4NK 829CKAL-3/4BZ</p>  <p style="text-align: center;">Country of Origin: USA</p>	<p>Powder-Coated Aluminum Cover Plate – Power or communication plate with 2" [51mm] and 3/4" [19.1mm] plugs. Covers are available in five decorative colors: black, gray, brass, nickel and bronze.</p> <p style="text-align: center;">Country of Origin: USA</p> <p>NOTE: Acceptable for use with threaded conduit when passing through power cables.</p>
<p>828MAAP</p>  <p style="text-align: center;">Country of Origin: USA</p>	<p>A/V Adapter Plate – Sheet metal adapter plate that accepts two (2) Legrand AVIP device plates Extron® Electronics MAAP style device plates (sold separately). For use with 828GFITC or 828GFITCAL cover plates. (Sold separately.)</p> <p style="text-align: center;">Country of Origin: USA</p>

NOTE: UL Listed for tile, terrazzo, polished concrete, wood and carpet floors.

Brass covers and flanges are not interchangeable with aluminum or nonmetallic covers and flanges. Nonmetallic covers are interchangeable with aluminum flanges.

All cover assemblies for the OmniBox Series Floor Box have TopGuard protection.



Fire Classified RFB2™ Series Multi-Service Steel Recessed Floor Box Ordering Information

Catalog No./Item

Description/Specifications

RFB2S-FC

Fire Classified Two-Compartment Box – For use in either concrete or wood floors. Fully adjustable with tunnel compartment. Supplied with one (1) duplex receptacle, mounting plate, and one (1) communication mounting plate (RFB22AB). Other device plates sold separately.

Country of Origin: USA

NOTE: For use in concrete pours ranging from 2" [51mm] to 5" [127mm] maximum pour depth.

NOTE: Floor Box spacing 2' on center and one for every 4 square feet in a span.

Four (4) #12 AWG Type THHN Power Conductors or 48 #23 AWG (6 Cat. 6) Tele Data Conductors per gang.

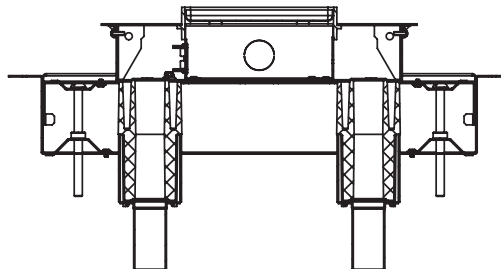
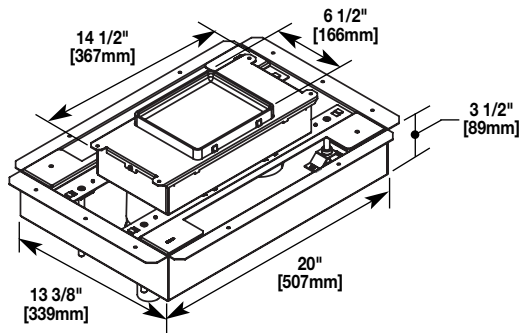

Fire Classified RFB2S-FC Series Floor Box Compartment Capacities, Knockout Locations & Sizes

RFB2S-FC

Power or Data
50.2 cu. in. [822.6 ml]
Each Side
Top View

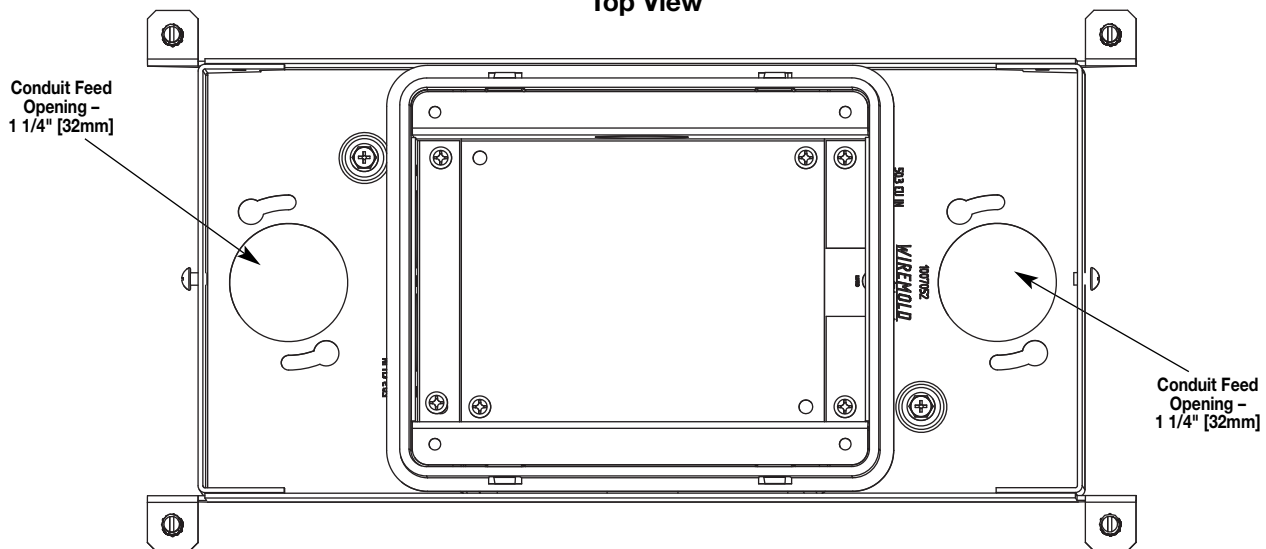

NOTE: UL Listed for tile, terrazzo, polished concrete, wood and carpet floors.

All cover assemblies for the RFB2S-FC Series Floor Box have TopGuard protection.

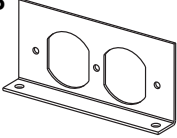
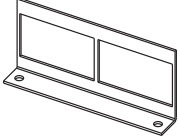
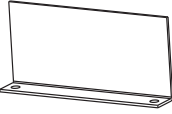
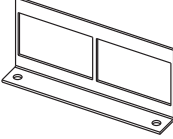
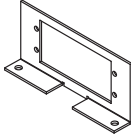
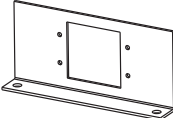
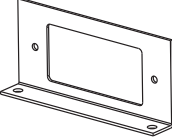

Fire Classified RFB2 Series Multi-Service Steel Recessed Floor Box Accessories

Catalog No./Item	Description/Specifications	Catalog No./Item	Description/Specifications
RFB2DP 	Internal Duplex Receptacle Bracket – Accepts standard 15A & 20A duplex receptacles. NOTE: For RFB2 Series Floor Boxes only.	RFB22AB 	Internal Communication Bracket – Includes two (2) adapters to accept Wiremold Open System communication inserts. (sold separately.) NOTE: For RFB2 Series Floor Boxes only.
RFB2B 	Internal Blank Bracket – Plate used to close off unused gangs. NOTE: For RFB2 Series Floor Boxes only.	RFB2RT 	Internal Communication Bracket – Includes two (2) adapters to accept Ortronics® TracJack devices, and two (2) adapters to accept Ortronics Series II devices. (sold separately.) NOTE: For RFB2 Series Floor Boxes only.
RFB2-AAP 	Internal Audio Video Bracket – Accepts Extron® Electronics AAP Series Devices. (Sold separately.) NOTE: For RFB2 Series Floor Boxes only.	RFB2EXT 	Internal Audio Video Bracket – Accepts two (2) Legrand AVIP devices or Extron® Electronics MAAP Series devices. (Sold separately.) NOTE: For RFB2 Series Floor Boxes only.
RFB2GFI 	Internal GFI or Decorator Style Receptacle Opening – Accepts standard GFCI or Decorator Style Receptacles, Communication or Audio/Video Devices. NOTE: For RFB2 Series Floor Boxes only.		

FLOORPORT PART NUMBER CONFIGURATOR

FP	B	TC	NK	NA
FloorPort Cover	Blank Top Cutout Top Furniture Feed	B C FF	Tile (Flangeless) Tile/Carpet (Flanged)	T TC
			Nickel Brass Black Bronze Gray Brushed Aluminum	NK BS BK BZ GY AL
				North American Made (Optional)

FloorPort™ Series Flanged Cover Assemblies Ordering Information

Catalog No./Item	Description/Specifications	Catalog No./Item	Description/Specifications
FPCTCBK FPCTCBZ FPCTCBS FPCTCNK FPCTCAL FPCTCGY	Cutout Cover Assembly – Flanged cover for use in tile or carpet installation. Die-cast aluminum assembly available in black (BK), bronze (BZ), brass (BS), nickel (NK), gray (GY), or brushed aluminum (AL). Insert in lid allows for carpet or tile cutouts to match finished floor. Country of Origin: India	FPBTCBK FPBTCBZ FPBTCBS FPBTCNK FPBTCAL FPBTCGY	Blank Cover Assembly – Flanged cover for use in tile or carpet installation. Die-cast aluminum assembly available in black (BK), bronze (BZ), brass (BS), nickel (NK), gray (GY), or brushed aluminum (AL). Lid area is flush with the finished floor, no cutouts provided. Country of Origin: India

North American Made FloorPort Series Flanged Cover Assemblies Ordering Information

Catalog No./Item	Description/Specifications	Catalog No./Item	Description/Specifications
FPCTCBK-NA FPCTCBZ-NA FPCTCBS-NA FPCTCNK-NA FPCTCGY-NA	Cutout Cover Assembly – Flanged cover for use in tile or carpet installation. Die-cast aluminum assembly available in black (BK), bronze (BZ), brass (BS), nickel (NK), or gray (GY). Insert in lid allows for carpet or tile cutouts to match finished floor. Country of Origin: USA	FPFFTCBK FPFFTCBZ FPFFTCBS FPFFTCNK FPFFTCAL FPFFTCGY	Furniture Feed Cover Assembly – Flanged cover for use in tile or carpet installation. Die-cast aluminum assembly available in black (BK), bronze (BZ), brass (BS), nickel (NK), gray (GY), or brushed aluminum (AL). Provided with one 1" trade size screw plug for power or communication type cabling and one combination 1 1/4" and 2" trade size screw plug for communication type cabling. Allows for feeding both power and communication cabling. Country of Origin: USA
FPBTCBK-NA FPBTCBZ-NA FPBTCBS-NA FPBTCNK-NA FPBTCGY-NA	Blank Cover Assembly – Flanged cover for use in tile or carpet installation. Die-cast aluminum assembly available in black (BK), bronze (BZ), brass (BS), nickel (NK), or gray (GY). Lid area is flush with the finished floor, no cutouts provided. Country of Origin: USA		

LOAD CAPACITIES FOR FLOORPORT COVER ASSEMBLIES	
CATALOG NUMBERS	MAXIMUM LOAD IN POUNDS
FPCTC	1000
FPBTC	750
FPFFTC	1000

NOTE: Pricing varies depending on country of origin. Consult your local sales representative for more information.

NOTE: Load applied through a 2" [51mm] mandrel in center of service fitting. Loads above are static loads only and do not pertain to rolling loads.

NOTE: UL Listed for tile, terrazzo, polished concrete, wood and carpet floors.

All cover assemblies for the RFB2S-FC Series Floor Box have TopGuard protection.



Fire Classified RFB4™ Series Multi-Service Steel Recessed Floor Box Ordering Information

Catalog No./Item

Description/Specifications

RFB4S-FC

Fire Classified Four-Compartment Box – Includes four duplex receptacle brackets. 12 3/4" L x 10" W x 3 7/16" D [324mm x 254mm x 87mm]. Fully adjustable. **Tunneling from adjacent compartments only, (not cross compartments).** Tunneling can be set to feed all four compartments from one conduit in a single-service application.

Country of Origin: USA

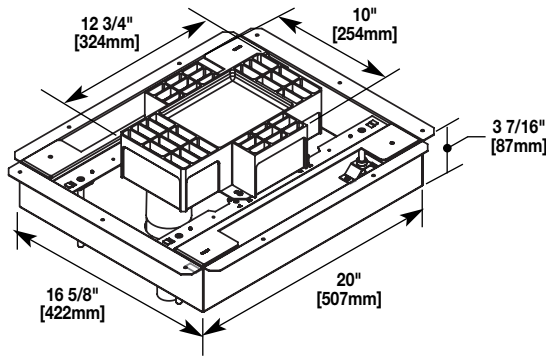

NOTES: For use in concrete pours ranging from 2" [51mm] to 5" [127mm] maximum pour depth.

Floor Box spacing 2' on center and one for every 4 square feet in a span.

Four (4) #12 AWG Type THHN Power Conductors or 48 #23 AWG (6 Cat. 6) Tele Data Conductors per gang.

All boxes and activations are sold separately.

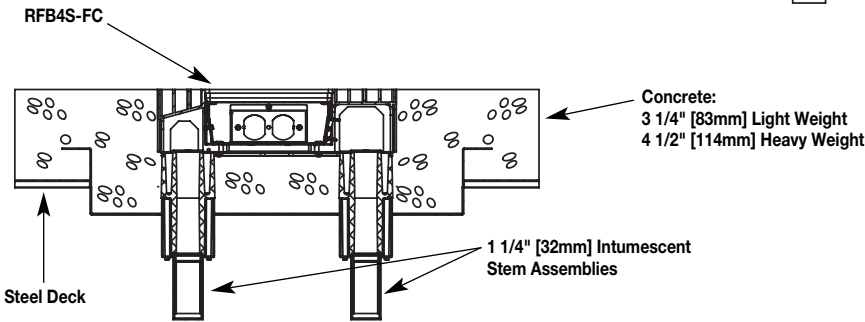
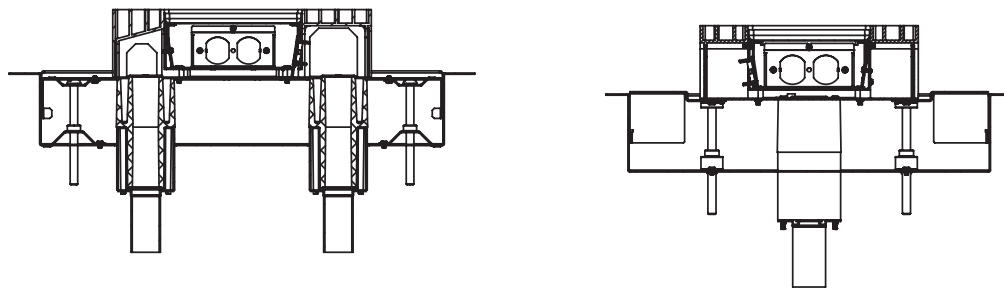

Fire Classified RFB4S-FC Series Compartment Capacities, Knockout Locations and Sizes

RFB4S-FC

Power or Data
22.5 cu in. [369ml]

Power or Data
25.5 cu in.
[418ml]

Conduit Feed
Opening –
1 1/4" [32mm]

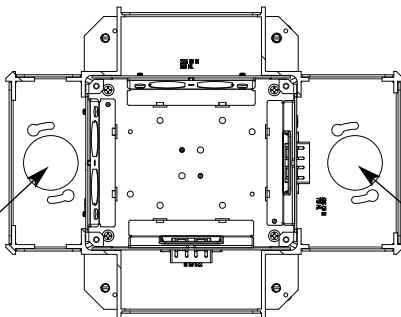

Power or Data
22.5 cu in. [369ml]

Power or Data
43.5 cu in.
[713ml]

Conduit Feed
Opening –
1 1/4" [32mm]

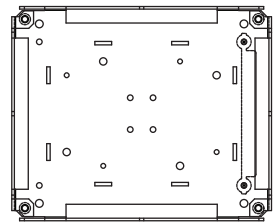
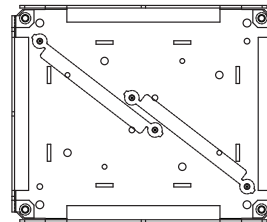

NOTE: UL Listed for tile, terrazzo, polished concrete, wood and carpet floors.

All cover assemblies for the RFB4S-FC Series Floor Box have TopGuard protection.

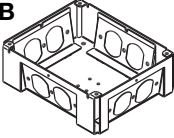
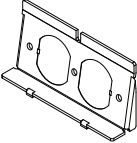
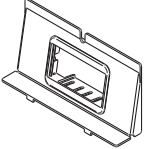
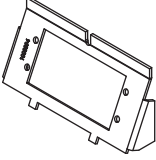
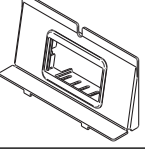
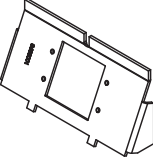
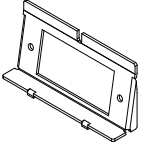

Fire Classified RFB4 Series Multi-Service Steel Recessed Floor Box Accessories

Catalog No./Item	Description/Specifications	Catalog No./Item	Description/Specifications
RFB-WTB 	Conversion Kit – Converts RFB4 Box to a RFB4-4DB Box. Country of Origin: USA	RFB-DR-4DB 	Internal Duplex Receptacle Bracket – Accepts 15 Amp and 20 Amp duplex receptacles. Country of Origin: USA NOTE: For use with RFB4-4DB.
WTB-2-AB 	Communication Bracket – One 2A size Pass & Seymour® Activate adapter included. Wiremold Open System inserts sold separately. Country of Origin: USA NOTE: For use with RFB4-4DB.	WTB-AAP 	Internal Audio Video Bracket – Accepts two (2) Legrand AVIP device plates or Extron® Electronics AAP Series devices. (Sold separately.) Country of Origin: USA NOTE: For use with RFB4-4DB.
WTB-2-RT 	Communication Bracket – Ortronics® AB2TJ TracJack and ABS2 Series II adapters included. Country of Origin: USA NOTE: For use with RFB4-4DB.	WTB-MAAP 	Internal Audio Video Bracket – Accepts two (2) Legrand AVIP device plates or Extron® Electronics MAAP Series devices. (Sold separately.) Country of Origin: USA NOTE: For use with RFB4-4DB.
RFB-GFI-4DB 	Internal GFCI or Decorator Style Receptacle Opening – Accepts standard GFCI or Decorator Style Receptacles, Communication or Audio/Video Devices. Country of Origin: USA NOTE: For use with RFB4-4DB.		

Additional configurations are available. Please consult your Wiremold Field Sales Representative for more information.

FLOORPORT PART NUMBER CONFIGURATOR

FP	B	TC	NK	NA
FloorPort	Blank Top	B	Nickel	NK
Cover	Cutout Top	C	Brass	BS
	Furniture Feed	FF	Black	BK
			Bronze	BZ
			Gray	GY
			Brushed Aluminum	AL
		Tile (Flangeless)	T	North American
		Tile/Carpet	TC	Made
		(Flanged)		(Optional)

FloorPort™ Series Flanged Cover Assemblies Ordering Information

Catalog No./Item	Description/Specifications	Catalog No./Item	Description/Specifications
FPCTCBK FPCTCBZ FPCTCBS FPCTCNK FPCTCAL FPCTCGY	Cutout Cover Assembly – Flanged cover for use in tile or carpet installation. Die-cast aluminum assembly available in black (BK), bronze (BZ), brass (BS), nickel (NK), gray (GY), or brushed aluminum (AL). Insert in lid allows for carpet or tile cutouts to match finished floor.	FPBTCBK FPBTCBZ FPBTCBS FPBTCNK FPBTCAL FPBTCGY	Blank Cover Assembly – Flanged cover for use in tile or carpet installation. Die-cast aluminum assembly available in black (BK), bronze (BZ), brass (BS), nickel (NK), gray (GY), or brushed aluminum (AL). Lid area is flush with the finished floor, no cutouts provided.
	Country of Origin: India		Country of Origin: India

North American Made FloorPort Series Flanged Cover Assemblies Ordering Information

Catalog No./Item	Description/Specifications	Catalog No./Item	Description/Specifications
FPCTCBK-NA FPCTCBZ-NA FPCTCBS-NA FPCTCNK-NA FPCTCGY-NA	Cutout Cover Assembly – Flanged cover for use in tile or carpet installation. Die-cast aluminum assembly available in black (BK), bronze (BZ), brass (BS), nickel (NK), or gray (GY). Insert in lid allows for carpet or tile cutouts to match finished floor.	FPFFTCBK FPFFTCBZ FPFFTCBS FPFFTCNK FPFFTCAL FPFFTCGY	Furniture Feed Cover Assembly – Flanged cover for use in tile or carpet installation. Die-cast aluminum assembly available in black (BK), bronze (BZ), brass (BS), nickel (NK), gray (GY), or brushed aluminum (AL). Provided with one 1" trade size screw plug for power or communication type cabling and one combination 1 1/4" and 2" trade size screw plug for communication type cabling. Allows for feeding both power and communication cabling.
	Country of Origin: USA		Country of Origin: USA
FPBTCBK-NA FPBTCBZ-NA FPBTCBS-NA FPBTCNK-NA FPBTCGY-NA	Blank Cover Assembly – Flanged cover for use in tile or carpet installation. Die-cast aluminum assembly available in black (BK), bronze (BZ), brass (BS), nickel (NK), or gray (GY). Lid area is flush with the finished floor, no cutouts provided.		
	Country of Origin: USA		

LOAD CAPACITIES FOR FLOORPORT COVER ASSEMBLIES

CATALOG NUMBERS	MAXIMUM LOAD IN POUNDS
FPCTC	1000
FPBTC	750
FPFFTC	1000

NOTE: Pricing varies depending on country of origin. Consult your local sales representative for more information.

NOTE: Load applied through a 2" [51mm] mandrel in center of service fitting. Loads above are static loads only and do not pertain to rolling loads.

NOTE: UL Listed for tile, terrazzo, polished concrete, wood and carpet floors.

All cover assemblies for the RFB4S-FC Series Floor Box have TopGuard protection.

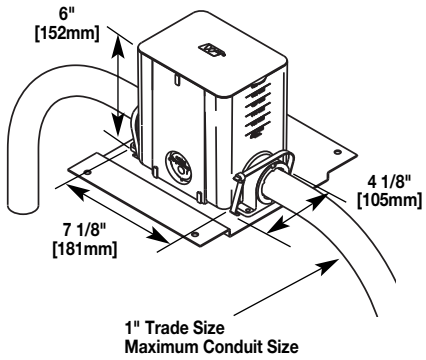
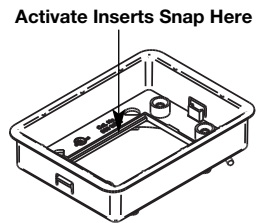

Fire Classified 880MP Floor Box Ordering Information

Catalog No./Item	Description/Specifications
<p>880MPFC</p>  <p style="text-align: center;">1" Trade Size Maximum Conduit Size</p>	<p>Fire Classified Nonmetallic Rectangular Floor Box – Box comes complete with reusable mudcap, insert spacer, conduit plugs and reducers. Reducers provided for reduction to 1", 3/4", and 1/2" [25mm, 19.1mm, and 12.7mm] conduit. Minimum concrete depth is 3 1/2" [89mm] and maximum concrete depth is 6" [152mm]. Minimum capacity is 50 cu. in. [819ml] and maximum capacity is 100 cu. in. [1639ml]. Box dimensions are 4 1/8" W x 5 1/2" L x 6" [105mm x 140mm x 152mm].</p> <p>Country of Origin: USA</p> <p>NOTES: Insert spacer should not be removed until after concrete pour. 880MPFC is a single gang offering. Can not gang boxes together and maintain Fire Classification. Floor Box spacing 2' on center and one for every 65 square foot in a span. Maximum Copper Cross Section per Insert: Four (4) #12 AWG Type THHN Power Conductor or 48 #23 AWG (6 Cat. 6) Tele Data conductors.</p>
<p>880MPA</p>  <p style="text-align: center;">Activate Inserts Snap Here</p>	<p>Nonmetallic Floor Box Adjusting Ring – Comes with fiber storage loop. Also includes brass inserts for flange connection and green ground wire for ground connection. Activate modular inserts snap directly into the adjusting ring without the need for a adapter. Also includes mounting screws to attach flange to box body. Ortronics connectivity inserts do not snap directly into the adjusting ring. For Ortronics inserts use the 828GFITC or 829PFLRT.</p> <p>Country of Origin: USA</p> <p>NOTE: One 880MPA is needed for each 880MPFC used.</p>

880MP Series Floor Boxes Solid Brass Cover Plate Flanges Ordering Information

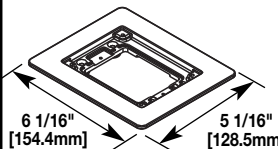
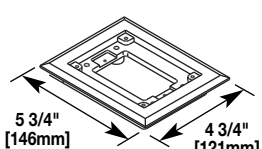
Catalog No./Item	Description/Specifications	Catalog No./Item	Description/Specifications
<p>817B</p>  <p style="text-align: center;">6 1/16" [154.4mm] 5 1/16" [128.5mm]</p>	<p>One-Gang Brass Combination Carpet & Tile Flange – Accepts Ortronics® MAB6TJ TracJack and MAB3S2 Series II adapters and Wiremold CM Series inserts, sold separately.</p> <p>Country of Origin: China</p>	<p>817C</p>  <p style="text-align: center;">5 3/4" [146mm] 4 3/4" [121mm]</p>	<p>One-Gang Brass Carpet Flange – For use on 880S1, 880M1, 880CS1-1, and 880CM1-1 Floor Boxes.</p> <p>Country of Origin: China</p>

NOTE: UL Listed for tile, terrazzo, polished concrete, wood and carpet floors.

Brass covers and flanges are not interchangeable with aluminum or nonmetallic covers and flanges. Nonmetallic covers are interchangeable with aluminum flanges.

All cover assemblies for the 880MPFC Series Floor Box have TopGuard protection.

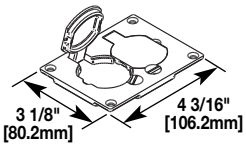
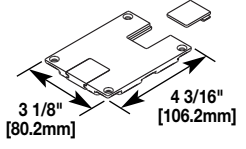
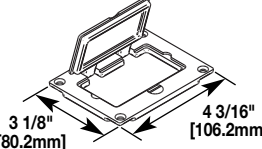
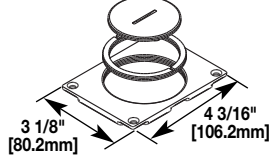
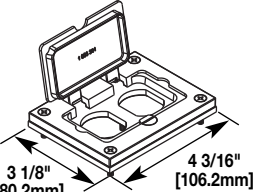
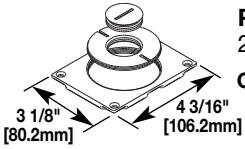
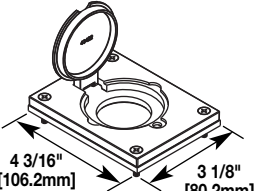
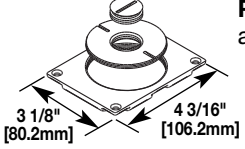
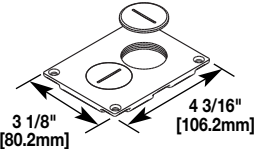
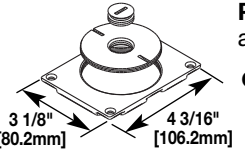
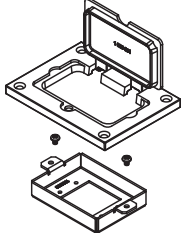

880MP Series Floor Boxes Metal Cover Plates Ordering Information

Catalog No./Item	Description/Specifications	Catalog No./Item	Description/Specifications
828R 	Brass Duplex Cover Plate – Flip lids. Can also be used with a 106 type communication adapter. Country of Origin: China	829STC 	Brass Communication Cover Plate – Data slides. Feed through only, not for use with a mounting plate for communication jacks. Country of Origin: China
828GFITC 	Brass GFI Cover Plate – May be used with Activate and Ortronics® Connectivity Systems in conjunction with 817B, 827B, and 837B Flanges. Country of Origin: China	829CK 	Brass Communication Cover Plate – 2 5/8" and 2 1/4" [67mm and 57mm] plugs. Country of Origin: China
828DPGFITC 	Brass Rectangular Cover Plate – Allows for mounting of a duplex style receptacle with a rectangular style flip lid cover. Country of Origin: China	829CK-1 	Brass Communication Cover Plate – 2 5/8" and 1" [67mm and 25mm] plugs. Country of Origin: China
828DLR 	Brass Single Locking Receptacle Cover Plate – Single flip lid cover for 20A or 30A single locking receptacles. Device opening is 2 5/8" [67mm]. For use with maximum female locking device of 1.58" diameter, and maximum male plug face of 2.25" diameter. Country of Origin: China	829CK-3/4 	Brass Communication Cover Plate – 2 5/8" and 3/4" [67mm and 19.1mm] plugs. Country of Origin: China
828SPTC 	Brass Duplex Cover Plate – Screw plugs. Screw plugs are 1 1/2" [38mm] in diameter. Country of Origin: China	829CK-1/2 	Brass Communication Cover Plate – 2 5/8" and 1/2" [67mm and 12.7mm] plugs. Country of Origin: China
828MAAP 	A/V Adapter Plate – Sheet metal adapter plate that accepts two (2) Legrand AVIP device plates or Extron® Electronics MAAP style device plates (sold separately). For use with 828GFITC or 828GFITCAL cover plates. (Sold separately.) Country of Origin: USA		

NOTE: UL Listed for tile, terrazzo, polished concrete, wood and carpet floors.

Brass covers and flanges are not interchangeable with aluminum or nonmetallic covers and flanges. Nonmetallic covers are interchangeable with aluminum flanges.

All cover assemblies for the 880MPFC Series Floor Box have TopGuard protection.

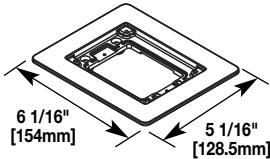

880MP Series Floor Boxes Brushed Aluminum Cover Plate Flanges Ordering Information

Catalog No./Item	Description/Specifications
<p>818TCAL</p>  <p>6 1/16" [154mm]</p> <p>5 1/16" [128.5mm]</p>	<p>One-Gang Brushed Aluminum Combination Carpet and Tile Flange – Accepts Ortronics® MAB6TJ TracJack and MAB3S2 Series II adapters and Wiremold CM Series inserts, sold separately.</p> <p>Country of Origin: China</p> <p>NOTE: Brushed aluminum flanges come with beveled edges.</p>

880MP Series Floor Boxes Metal Cover Plates Ordering Information

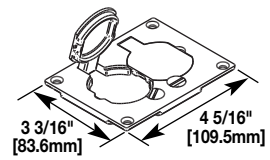
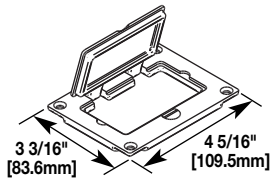
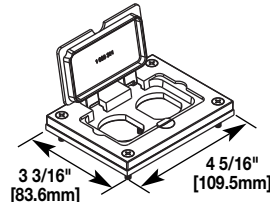
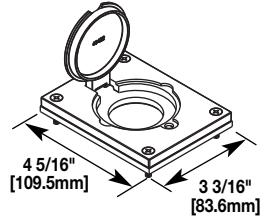
Catalog No./Item	Description/Specifications
<p>828R-TCAL</p>  <p>3 3/16" [83.6mm]</p> <p>4 5/16" [109.5mm]</p>	<p>Brushed Aluminum Duplex Cover Plate – Flip lids. Can also be used with a 106 type communication adapter.</p> <p>Country of Origin: China</p>
<p>828GFITCAL</p>  <p>3 3/16" [83.6mm]</p> <p>4 5/16" [109.5mm]</p>	<p>Brushed Aluminum GFI Cover Plate – May be used with Activate and Ortronics® Connectivity Systems in conjunction with 817B, 827B, and 837B Flanges.</p> <p>Country of Origin: China</p>
<p>828DPGFITCAL</p>  <p>3 3/16" [83.6mm]</p> <p>4 5/16" [109.5mm]</p>	<p>Brushed Aluminum Rectangular Cover Plate – Allows for mounting of a duplex style receptacle with a rectangular style flip lid cover.</p> <p>Country of Origin: China</p>
<p>828DLRAL</p>  <p>4 5/16" [109.5mm]</p> <p>3 3/16" [83.6mm]</p>	<p>Brushed Aluminum Single Locking Receptacle Cover Plate – Single flip lid cover for 20A or 30A single locking receptacles. Device opening is 2 5/8" [67mm]. For use with maximum female locking device of 1.58" diameter, and maximum male plug face of 2.25" diameter</p> <p>Country of Origin: China</p>

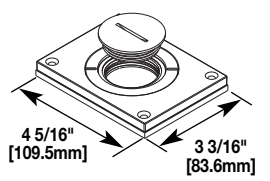
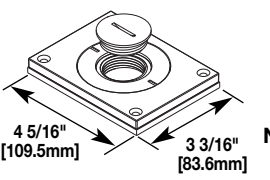
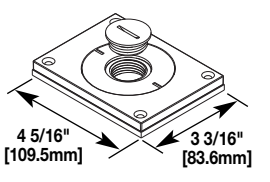
Catalog No./Item	Description/Specifications
<p>830CKTCAL</p>  <p>4 5/16" [109.5mm]</p> <p>3 3/16" [83.6mm]</p>	<p>Brushed Aluminum Cover Plate – Power or communication plate with 2" [51mm] and 1 1/4" [32mm] plugs.</p> <p>Country of Origin: China</p> <p>NOTE: Acceptable for use with threaded conduit when passing through power cables.</p>
<p>830CKTCAL-1</p>  <p>4 5/16" [109.5mm]</p> <p>3 3/16" [83.6mm]</p>	<p>Brushed Aluminum Cover Plate – Power or communication plate with 2" [51mm] and 1" [25mm] plugs.</p> <p>Country of Origin: China</p> <p>NOTE: Acceptable for use with threaded conduit when passing through power cables.</p>
<p>830CKTCAL-3/4</p>  <p>4 5/16" [109.5mm]</p> <p>3 3/16" [83.6mm]</p>	<p>Brushed Aluminum Cover Plate – Power or communication plate with 2" [51mm] and 3/4" [19.1mm] plugs.</p> <p>Country of Origin: China</p> <p>NOTE: Acceptable for use with threaded conduit when passing through power cables.</p>

NOTE: UL Listed for tile, terrazzo, polished concrete, wood and carpet floors.
Brass covers and flanges are not interchangeable with aluminum or nonmetallic covers and flanges. Nonmetallic covers are interchangeable with aluminum flanges.

All cover assemblies for the 880MPFC Series Floor Box have TopGuard protection.

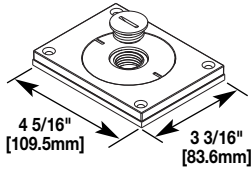
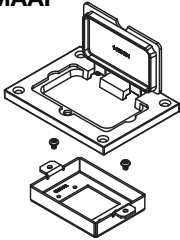

880MP Series Floor Boxes Metal Cover Plates Ordering Information (continued)

Catalog No./Item	Description/Specifications	Catalog No./Item	Description/Specifications
830CKTAL-1/2 	Brushed Aluminum Cover Plate – Power or communication plate with 2" [51mm] and 1/2" [12.7mm] plugs. Country of Origin: China NOTE: Acceptable for use with threaded conduit when passing through power cables.	828MAAP 	A/V Adapter Plate – Sheet metal adapter plate that accepts two (2) Legrand AVIP device plates or Extron® Electronics MAAP style device plates (sold separately). For use with 828GFITC or 828GFITCAL cover plates. (Sold separately) Country of Origin: USA

880MP Series Floor Boxes Powder-Coated Aluminum Cover Plate Flanges Ordering Information

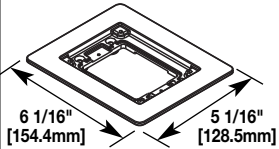
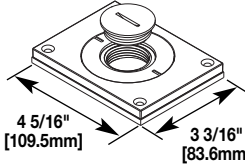
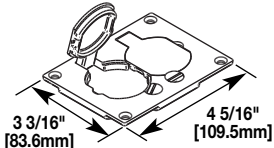
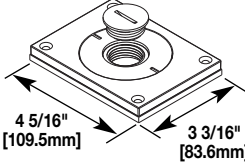
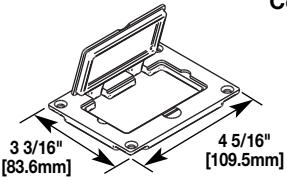
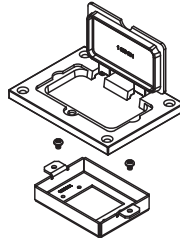
Catalog No./Item	Description/Specifications	Catalog No./Item	Description/Specifications
817TCAL-BK 817TCAL-GY 817TCAL-BS 817TCAL-NK 817TCAL-BZ 	One-Gang Powder-Coated Aluminum Combination Carpet and Tile Flange – Accepts Ortronics® MAB6TJ TracJack and MAB3S2 Series II adapters and Wiremold CM Series inserts, sold separately. Flanges are available in five decorative colors: black, gray brass, nickel and bronze. Country of Origin: USA	829CKAL-1BK 829CKAL-1GY 829CKAL-1BS 829CKAL-1NK 829CKAL-1BZ 	Powder-Coated Aluminum Cover Plate – Power or communication plate with 2" [51mm] and 1" [25mm] plugs. Covers are available in five decorative colors: black, gray, brass, nickel and bronze. Country of Origin: USA NOTE: Acceptable for use with threaded conduit when passing through power cables.
828R-TCAL-BK 828R-TCAL-GY 828R-TCAL-BS 828R-TCAL-NK 828R-TCAL-BZ 	Powder-Coated Aluminum Duplex Cover Plate – Flip lids. Can also be used with a 106 type communication adapter. Country of Origin: USA	829CKAL-3/4BK 829CKAL-3/4GY 829CKAL-3/4BS 829CKAL-3/4NK 829CKAL-3/4BZ 	Powder-Coated Aluminum Cover Plate – Power or communication plate with 2" [51mm] and 3/4" [19.1mm] plugs. Covers are available in five decorative colors: black, gray, brass, nickel and bronze. Country of Origin: USA NOTE: Acceptable for use with threaded conduit when passing through power cables.
828GFITCAL-BK 828GFITCAL-GY 828GFITCAL-BS 828GFITCAL-NK 828GFITCAL-BZ 	Powder-Coated Aluminum Rectangular Cover Plate – Allows for mounting a duplex receptacle (Decorator or GFCI style) with a rectangular flip cover Country of Origin: USA	828MAAP 	A/V Adapter Plate – Sheet metal adapter plate that accepts two (2) Legrand AVIP device plates or Extron® Electronics MAAP style device plates (sold separately). For use with 828GFITC or 828GFITCAL cover plates. (Sold separately) Country of Origin: USA

NOTE: UL Listed for tile, terrazzo, polished concrete, wood and carpet floors.

Brass covers and flanges are not interchangeable with aluminum or nonmetallic covers and flanges. Nonmetallic covers are interchangeable with aluminum flanges.

All cover assemblies for the 880MPFC Series Floor Box have TopGuard protection.



880MP Series Floor Boxes Nonmetallic Cover Plate Flanges Ordering Information

Catalog No./Item	Description/Specifications
<p>817PCC-BLK 817PCC-BRN</p>  <p style="font-size: small;">5 3/4" [146mm]</p> <p style="font-size: small;">4 3/4" [121mm]</p>	<p>One-Gang Nonmetallic Carpet Flange – Available in black or brown. For Ortronics® connectivity use with 829PFLRT Cover. For Activate connectivity use with 829PFL Cover. Accepts Ortronics® MAB6TJ TracJack and MAB3S2 Series II adapters and Wiremold CM Series inserts, sold separately.</p> <p>Country of Origin: Mexico</p>

NOTE: UL Listed for tile, terrazzo, polished concrete, wood and carpet floors.
Brass covers and flanges are not interchangeable with aluminum or nonmetallic covers and flanges. Nonmetallic covers are interchangeable with aluminum flanges.

All cover assemblies for the 880MPFC Series Floor Box have TopGuard protection.



Fire Classified Ratchet-Pro PVC Floor Box Ordering Information

Catalog No./Item

Description/Specifications

881FC

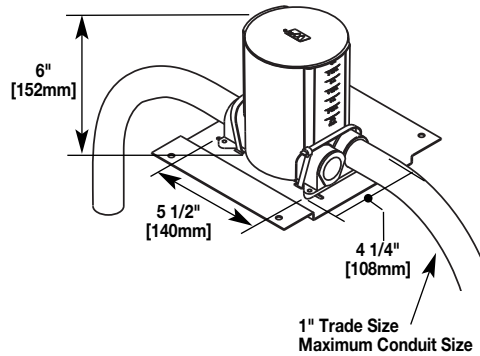

Round PVC Floor Box – Supplied with reusable concrete cap, conduit reducers, and conduit hub plugs. Available for single service only. Graduated cubic inch markings inside the box indicate volume capacity at any depth. Box has parallel conduit hubs eliminating the need for 90° sweeps in installation. One-piece conduit reducers from 1" to 1/2" [25mm to 12.7mm] conduit. Reducers and plugs located on a mounting bar for easier selection. For concrete pours of 2 1/4" to 6" [57mm to 152mm].

Country of Origin: USA

NOTES: Floor Box spacing 2' on center and one for every 65 square foot in a span.
Maximum Copper Cross Section per Insert: Four (4) #12 AWG Type THHN Power Conductor or 48 #23 AWG (6 Cat. 6) Tele Data conductors.

881ADP

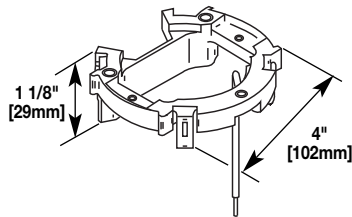

PVC Floor Box Ratchet Adjusting Ring – Used to attach wiring devices and cover plates to PVC Box. Locks into place without using glue or mechanical fasteners. Compensates for up to 10° of tilt if box is not level. Ground wire is factory attached to the adjusting ring.

Country of Origin: USA

NOTE: One ring required per box, single-or dual-service.

Volume Capacities for Ratchet-Pro PVC Floor Box

BOX HEIGHT		Single Service 895 Activation	
		WIRING VOLUME	
In	[mm]	Cu. In	[ml]
6	[152.0]	56.0	[917.0]
5 1/2	[140.0]	49.0	[803.0]
5	[127.0]	42.0	[688.0]
4 1/2	[114.0]	35.0	[574.0]
4	[102.0]	28.0	[459.0]
3 1/2	[89.0]	21.0	[344.0]
3 1/4	[76.0]	17.0	[278.0]

NOTE: To calculate total box volume, use the displacement of the largest uncut section remaining.

NOTE: UL Listed for tile, terrazzo, polished concrete, wood and carpet floors.

All cover assemblies for the 881FC Series Floor Box have TopGuard protection.

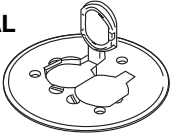
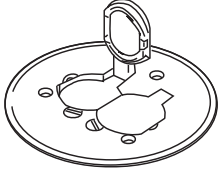
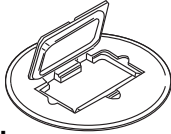

Cover Plates for 881FC Floor Box

Catalog No./Item	Description/Specifications	Catalog No./Item	Description /Specifications
895 895TCAL	 <p>Brass/Brushed Aluminum Duplex Cover Plate – With flip lids, 5 1/2" [140mm] diameter for carpet. Country of Origin: China</p>	895TCAL-BK 895TCAL-BS 895TCAL-GY 895TCAL-NK 895TCAL-BZ	<p>Aluminum Duplex Power Plate – With flip lids, 5 1/2" [140mm] diameter for carpet. Available in black (895AL-BK), brass (895AL-BS), gray (895AL-GY), nickel (895AL-NK), and bronze (895AL-BZ).</p>
895T 895TAL	<p>Brass/Brushed Aluminum Duplex Cover Plate – With flip lids, 4 1/4" [108mm] diameter for tile. Country of Origin: China</p>		<p>Country of Origin: USA</p>
895GFI 895GFICAL	 <p>Brass/Brushed Aluminum GFI Receptacle Cover Plate – 5 1/2" [140mm] diameter for carpet. Country of Origin: China</p>		
895TGFI 895TGFIAL	<p>Brass/Brushed Aluminum GFI Receptacle Cover Plate – 4 1/4" [108mm] diameter for tile. Country of Origin: China</p>		

CAUTION

Installation must comply with NEC and local code conductor volume requirements. Not for use when concrete is the finished floor. Use only for tile, carpet, or wood covered floors.

NOTE: 1. All cover plates are furnished with gasket and three screws.
2. Polycarbonate cover plates cannot be used on the 881FC Fire Classified Floor Box.

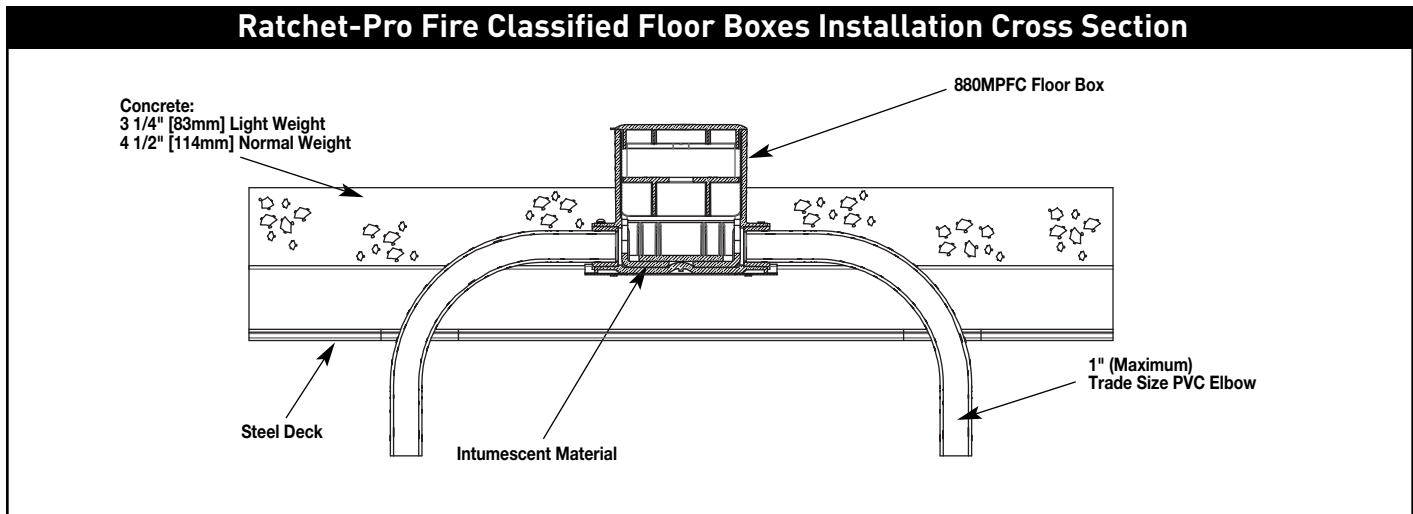

NOTE: UL Listed for tile, terrazzo, polished concrete, wood and carpet floors.

All cover assemblies for the 881FC Series Floor Box have TopGuard protection.



Electrical Wiring Systems
 60 Woodlawn Street
 West Hartford, CT 06110
 Phone: 1.877.BY.LEGRAND (295-3472)
 www.legrand.us
 570 Applewood Crescent
 Vaughan, Ontario L4K 4B4
 Phone: 905.738.9195
 www.legrand.ca

