



Wiremold

Walkerflex® Modular Wiring System

New Walkerflex® Modular Wiring System Offers Labor Savings Compared To Hard-Wired Systems

Wiremold® Walkerflex® Modular Wiring System is a factory assembled connector and cable set system, designed to interface with various power applications: raised floor boxes, service poles, surface raceways, wireways, and convenience outlets. This design, with its plug-n-play feature, provides tremendous wire management flexibility and labor savings vs. traditional pipe and box wiring methods.

The new Walkerflex Modular Wiring System is ideal for use in raised floor systems and in combination with FloorSource™ Raised Floor Boxes. Both products are suited for commercial offices, computer rooms, schools or any facility with a demand for high flexibility in wiring requirements

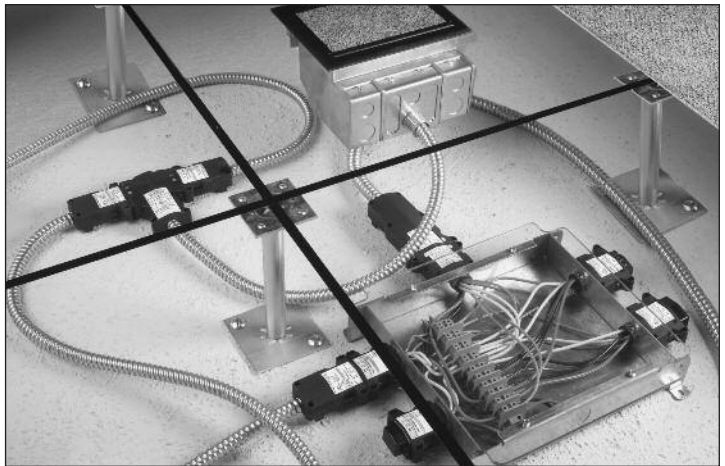

Walkerflex Modular Wiring System in a raised floor installation.

FEATURES & BENEFITS

- **Modular system design, with flexible metal clad cables that plug into each other.** Save up to 60% in labor costs for installation compared to pipe and box or BX and J-box wiring.
- **Modular plug-n-play components.** Provides system flexibility. Easily re-use and relocate components. Relocation costs are reduced.
- **Pin and sleeve contact design.** Provides reliability of electrical connections. Allows "First-to-Make, Last-to-Break" ground terminators which reduces potential electrical hazards.
- **Designed for up to a maximum of 6 circuits.** Provides a wide variety of wiring configurations, while offering maximum system flexibility.
- **10-Wire systems available.** Provides a flexible wiring solution for more demanding workstation power requirements, e.g. multiple neutral, isolated ground, and up to six circuits.
- **Mechanical locking feature with an audible snap.** Ensures a solid mechanical connection with maximum contact engagement.
- **A system integrator.** Interfaces with various wire management solutions including: Service Poles, Tele-Power® Poles, Raised Floor Boxes, and Surface Raceway Systems for additional labor savings and flexibility.
- **#10 AWG neutrals incorporated.** Addresses nonlinear loads in the electrical environment.
- **Made in the USA.** Assembled and tested by skilled wiring professionals to meet the job specifications.
- **Meets NEC Section 300-22(c).** Products are suitable for use in air handling spaces other than ducts and plenums.
- **UL Listed** – to U.S. and Canadian safety standards for 20A 120V/208V and 277V/480V systems. Ideal for plug load and lighting applications.

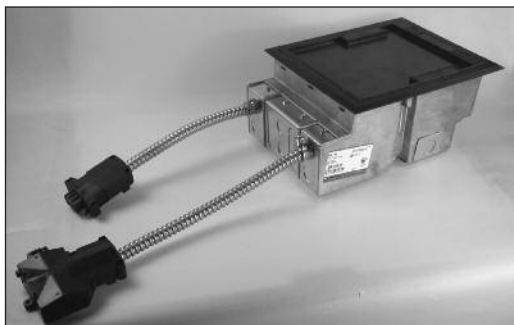

Prewired AF Series Box

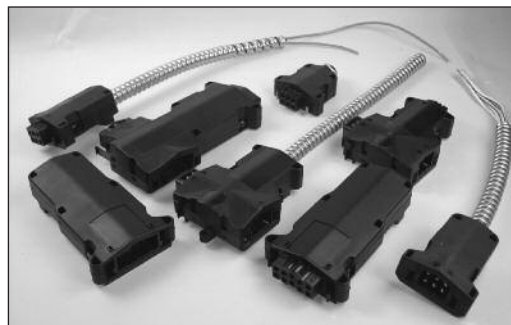

Walkerflex Power Adapters, Cable Splitters, and male and female Wire Connectors.

System Layout

Typical workstation layout using Walkerflex products to feed furniture panel and AF Series Raised Floor Box in a raised floor application.

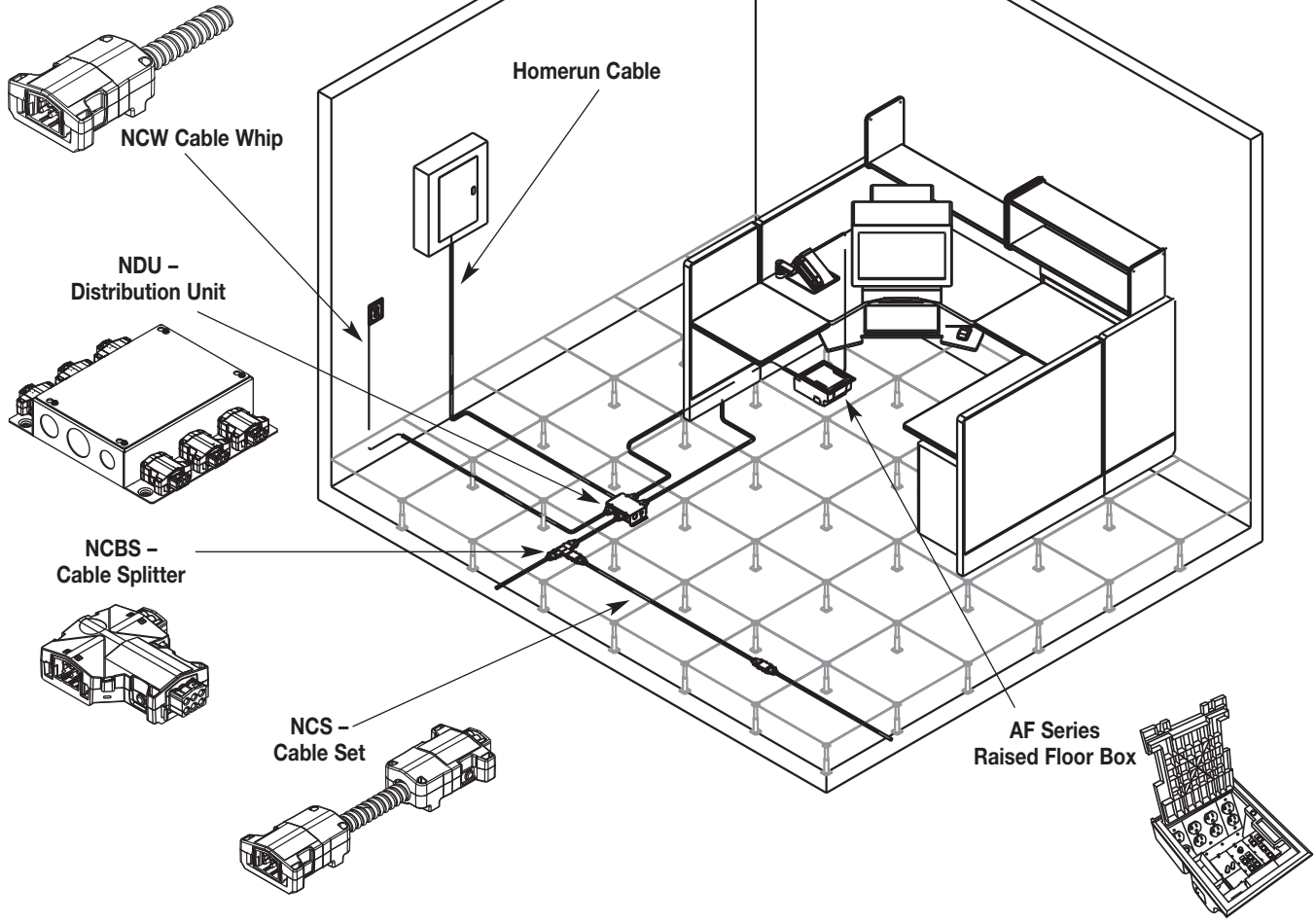

Typical Installation

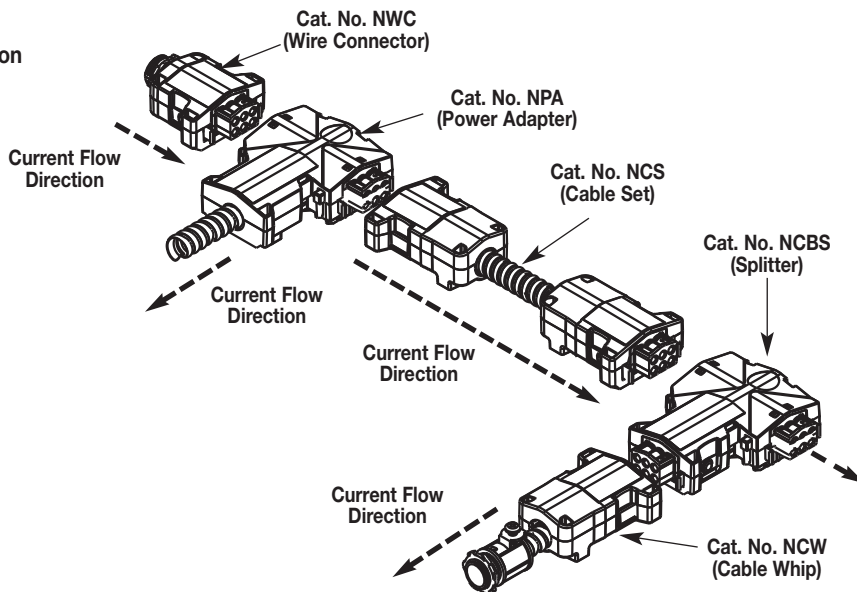

Walkerflex System Components

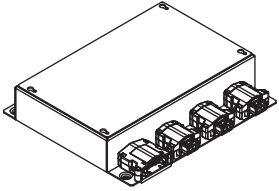
Catalog No.	Item/Description/Specifications
<p>Prewired Distribution Unit</p> 	<p>Conversion point from electrical closet to the Walkerflex System. Unit can be prewired to buss bar system or be prewired with home run cable. Consult factory for prewiring home run cable.</p> <p>NOTE: All distribution units are wired with #10 AWG wire and a #12 Equipment ground.</p> <p>Example: NDUP222WC6</p>

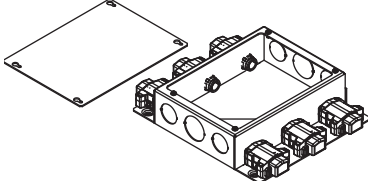
<p>Unwired Distribution Unit</p> 	<p>Conversion point from electrical closet to the Walkerflex System. Unit is for field wiring.</p> <p>NOTE: All distribution units are wired with #10 AWG wire and a #12 Equipment ground.</p> <p>Example: NDU222WC6</p>
---------------------------------------------------------------------------------------------------------------------------	----------------------------------------------------------------------------------------------------------------------------------------------------------------------------------------------------------------------------------------

<u>NDU</u>	<u>P</u>	<u>2</u>	<u>2</u>	<u>2</u>	<u>WC</u>	<u>6</u>
<p>Identifies the Distribution Unit NDU = 120V LDU = 277V</p>	<p>Identifies how unit is wired: () Unwired – No identifier needed (see unwired example above (P) Prewired (S) Prewired with a Modular “IN” Feed Connector.</p>	<p>Number of Circuits, also number of Hot Conductors per Connector. Insert “1” for single circuit, “2” for two-circuit, “3” for three-circuit, “4” for four-circuit, or “6” for six-circuit.</p>	<p>Identifies Number of Neutral Conductors per Connector, Four (4) Conductors maximum. All Neutrals #10 AWG.</p>	<p>Number of Ground Conductors per Connector. Insert “1” for one System Ground or “2” for one System Ground and one Isolated Ground.</p>	<p>“WC” stands for Wire Connector. Remains constant.</p>	<p>Identifies Number of Power “OUT” Wire Connectors.</p>

NOTE: See available wiring configuration options on page 7.

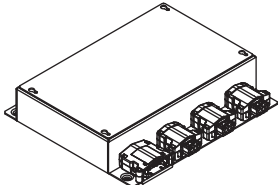
<p>Modular Prewired Distribution Unit</p> 	<p>Prewired distribution unit with a modular “IN” feed. Unit can be prewired to buss bar system or be prewired with wire nuts. Standard number of wire connector configurations are: 2, 4, 6, or 8. For custom configurations, consult factory.</p> <p>NOTE: All distribution units are wired with #10 AWG wire and a #12 Equipment ground.</p> <p>Example: NDUS332F111WC3</p>
--------------------------------------------------------------------------------------------------------------------------------------	----------------------------------------------------------------------------------------------------------------------------------------------------------------------------------------------------------------------------------------------------------------------------------------------------------------------------------------------------------------------------------------------

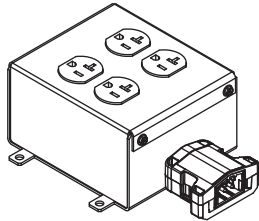

<u>NDUS</u>	<u>3</u>	<u>3</u>	<u>2</u>	<u>F</u>	<u>1</u>	<u>1</u>	<u>1</u>	<u>WC</u>	<u>3</u>
<p>Identifies the Distribution Unit NDUS = 120V LDUS = 277V</p>	<p>Number of Feed Circuits. Insert “1” for single circuit, “2” for two-circuit, “3” for three-circuit, “4” for four-circuit, or “6” for six-circuit.</p>	<p>Identifies Number of Neutral Conductors per Connector, Four (4) Conductors maximum. All Neutrals #10 AWG.</p>	<p>Number of Ground Conductors. Insert “1” for one System Ground or “2” for one System Ground and one Isolated Ground.</p>	<p>Identifies “Power In”.</p>	<p>Number of Feed Circuits. Insert “1” for single circuit, “2” for two-circuit, “3” for three-circuit, “4” for four-circuit, or “6” for six-circuit.</p>	<p>Identifies Number of Neutral Conductors per Connector, Four (4) Conductors maximum. All Neutrals #10 AWG.</p>	<p>Number of Ground Conductors. Insert “1” for one System Ground or “2” for one System Ground and one Isolated Ground.</p>	<p>“WC” stands for Wire Connector. Remains constant.</p>	<p>Identifies Number of Power “OUT” Wire Connectors.</p>

Walkerflex System Components

Catalog No.	Item/Description/Specifications								
<p>Receptacle Distribution Unit</p> 	<p>Prewired receptacle unit that is fed with the flex system.</p> <p>NOTE: Not suitable for use in air handling spaces.</p> <table border="1" style="width: 100%; border-collapse: collapse; margin-top: 10px;"> <thead> <tr> <th style="width: 25%; text-align: center;"><u>RECDO</u></th> <th style="width: 25%; text-align: center;"><u>1</u></th> <th style="width: 25%; text-align: center;"><u>1</u></th> <th style="width: 25%; text-align: center;"><u>1</u></th> </tr> </thead> <tbody> <tr> <td style="vertical-align: top;"> <p>Identifies the Receptacle Distribution Unit. Remains constant.</p> <p>Example: RECDO111</p> </td> <td style="vertical-align: top;"> <p>Number of Circuits, also number of Hot Conductors. Insert "1" for single circuit, "2" for two-circuit, "3" for three-circuit, "4" for four-circuit, or "6" for six-circuit.</p> </td> <td style="vertical-align: top;"> <p>Identifies number of Neutral Conductors. Four (4) Conductors maximum.</p> <p>All Neutrals #10 AWG.</p> </td> <td style="vertical-align: top;"> <p>Number of Ground Conductors. Insert "1" for one System Ground or "2" for one System Ground and one Isolated Ground.</p> </td> </tr> </tbody> </table>	<u>RECDO</u>	<u>1</u>	<u>1</u>	<u>1</u>	<p>Identifies the Receptacle Distribution Unit. Remains constant.</p> <p>Example: RECDO111</p>	<p>Number of Circuits, also number of Hot Conductors. Insert "1" for single circuit, "2" for two-circuit, "3" for three-circuit, "4" for four-circuit, or "6" for six-circuit.</p>	<p>Identifies number of Neutral Conductors. Four (4) Conductors maximum.</p> <p>All Neutrals #10 AWG.</p>	<p>Number of Ground Conductors. Insert "1" for one System Ground or "2" for one System Ground and one Isolated Ground.</p>
<u>RECDO</u>	<u>1</u>	<u>1</u>	<u>1</u>						
<p>Identifies the Receptacle Distribution Unit. Remains constant.</p> <p>Example: RECDO111</p>	<p>Number of Circuits, also number of Hot Conductors. Insert "1" for single circuit, "2" for two-circuit, "3" for three-circuit, "4" for four-circuit, or "6" for six-circuit.</p>	<p>Identifies number of Neutral Conductors. Four (4) Conductors maximum.</p> <p>All Neutrals #10 AWG.</p>	<p>Number of Ground Conductors. Insert "1" for one System Ground or "2" for one System Ground and one Isolated Ground.</p>						

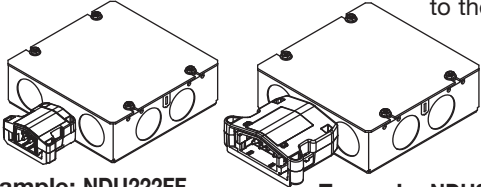
NOTE: See available wiring configuration options on page 7.

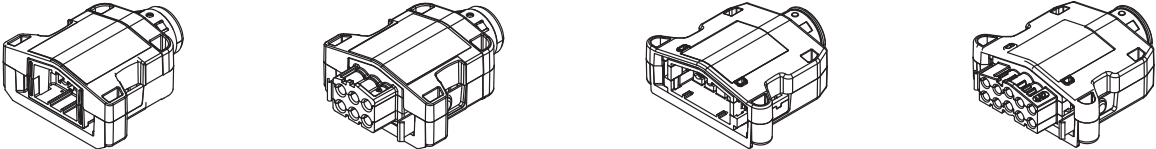
Catalog No.	Item/Description/Specifications										
<p>Furniture Feed Distribution Unit</p>  <p>Example: NDU222FF Example: NDU332FF</p>	<p>Conversion point from rigid EMT, BX, or other listed manufactured wiring systems to the Walkerflex Modular Wiring System.</p> <p>NOTE: Units need to be field wired.</p> <table border="1" style="width: 100%; border-collapse: collapse; margin-top: 10px;"> <thead> <tr> <th style="width: 25%; text-align: center;"><u>NDU</u></th> <th style="width: 25%; text-align: center;"><u>3</u></th> <th style="width: 25%; text-align: center;"><u>3</u></th> <th style="width: 25%; text-align: center;"><u>2</u></th> <th style="width: 25%; text-align: center;"><u>FF</u></th> </tr> </thead> <tbody> <tr> <td style="vertical-align: top;"> <p>Identifies the Furniture Feed Distribution Unit.</p> <p>NDU = 120V LDU = 277V</p> </td> <td style="vertical-align: top;"> <p>Number of Circuits, also number of Hot Conductors. Insert "1" for single circuit, "2" for two-circuit, "3" for three-circuit, "4" for four-circuit, or "6" for six-circuit.</p> </td> <td style="vertical-align: top;"> <p>Identifies number of Neutral Conductors. Four (4) Conductors maximum.</p> <p>All Neutrals #10 AWG.</p> </td> <td style="vertical-align: top;"> <p>Number of Ground Conductors. Insert "1" for one System Ground or "2" for one System Ground and one Isolated Ground.</p> </td> <td style="vertical-align: top;"> <p>"FF" stands for Furniture Feed. Remains constant.</p> </td> </tr> </tbody> </table>	<u>NDU</u>	<u>3</u>	<u>3</u>	<u>2</u>	<u>FF</u>	<p>Identifies the Furniture Feed Distribution Unit.</p> <p>NDU = 120V LDU = 277V</p>	<p>Number of Circuits, also number of Hot Conductors. Insert "1" for single circuit, "2" for two-circuit, "3" for three-circuit, "4" for four-circuit, or "6" for six-circuit.</p>	<p>Identifies number of Neutral Conductors. Four (4) Conductors maximum.</p> <p>All Neutrals #10 AWG.</p>	<p>Number of Ground Conductors. Insert "1" for one System Ground or "2" for one System Ground and one Isolated Ground.</p>	<p>"FF" stands for Furniture Feed. Remains constant.</p>
<u>NDU</u>	<u>3</u>	<u>3</u>	<u>2</u>	<u>FF</u>							
<p>Identifies the Furniture Feed Distribution Unit.</p> <p>NDU = 120V LDU = 277V</p>	<p>Number of Circuits, also number of Hot Conductors. Insert "1" for single circuit, "2" for two-circuit, "3" for three-circuit, "4" for four-circuit, or "6" for six-circuit.</p>	<p>Identifies number of Neutral Conductors. Four (4) Conductors maximum.</p> <p>All Neutrals #10 AWG.</p>	<p>Number of Ground Conductors. Insert "1" for one System Ground or "2" for one System Ground and one Isolated Ground.</p>	<p>"FF" stands for Furniture Feed. Remains constant.</p>							

Catalog No.	Item/Description/Specifications																		
<p>Wire Connectors</p> <p>SNAP RING STYLE</p>  <p>Example: NWC222AL12FS Example: NWC222AL12MS Example: NWC332AL12FS Example: NWC332AL12MS</p> <p>LOCKING RING STYLE</p>  <p>Example: NWC222AL12FL Example: NWC222AL12ML</p>	<p>Connectors are used to transition between the distribution units, cable sets, and end devices (floor boxes, poles, or raceway). Standard wire lengths are 8", 12" and 18" [203mm, 305mm, and 457mm].</p> <p>NOTE: Locking Ring style is only available up to 6 wire configurations.</p> <table border="1" style="width: 100%; border-collapse: collapse; margin-top: 10px;"> <thead> <tr> <th style="width: 12.5%; text-align: center;"><u>NWC</u></th> <th style="width: 12.5%; text-align: center;"><u>2</u></th> <th style="width: 12.5%; text-align: center;"><u>2</u></th> <th style="width: 12.5%; text-align: center;"><u>2</u></th> <th style="width: 12.5%; text-align: center;"><u>A</u></th> <th style="width: 12.5%; text-align: center;"><u>L</u></th> <th style="width: 12.5%; text-align: center;"><u>12</u></th> <th style="width: 12.5%; text-align: center;"><u>F</u></th> <th style="width: 12.5%; text-align: center;"><u>S</u></th> </tr> </thead> <tbody> <tr> <td style="vertical-align: top;"> <p>Identifies the Wire Connector.</p> <p>NWC= 120V LWC = 277V</p> </td> <td style="vertical-align: top;"> <p>Number of Circuits, also number of Hot Conductors. Insert "1" for single circuit, "2" for two-circuit, "3" for three-circuit, "4" for four-circuit, or "6" for six-circuit.</p> </td> <td style="vertical-align: top;"> <p>Identifies number of Neutral Conductors. Four (4), Conductors maximum.</p> <p>All Neutrals #10 AWG.</p> </td> <td style="vertical-align: top;"> <p>Number of Ground Conductors. Insert "1" for one System Ground or "2" for one System Ground and one Isolated Ground.</p> </td> <td style="vertical-align: top;"> <p>Identifies Gage of Hot and Ground Conductors.</p> <p>(A) = #12 AWG (B) = #10 AWG</p> </td> <td style="vertical-align: top;"> <p>Identifies Length. "L" remains constant.</p> </td> <td style="vertical-align: top;"> <p>Identifies Length of Wires (in inches) protruding out of back side of the Connector.</p> </td> <td style="vertical-align: top;"> <p>Identifies Power Direction "F" (Female) for Power "IN", "M" (Male) for Power "OUT".</p> </td> <td style="vertical-align: top;"> <p>Identifies method of securing in device. "L" for Lock Nut, "S" for Snap Ring.</p> </td> </tr> </tbody> </table>	<u>NWC</u>	<u>2</u>	<u>2</u>	<u>2</u>	<u>A</u>	<u>L</u>	<u>12</u>	<u>F</u>	<u>S</u>	<p>Identifies the Wire Connector.</p> <p>NWC= 120V LWC = 277V</p>	<p>Number of Circuits, also number of Hot Conductors. Insert "1" for single circuit, "2" for two-circuit, "3" for three-circuit, "4" for four-circuit, or "6" for six-circuit.</p>	<p>Identifies number of Neutral Conductors. Four (4), Conductors maximum.</p> <p>All Neutrals #10 AWG.</p>	<p>Number of Ground Conductors. Insert "1" for one System Ground or "2" for one System Ground and one Isolated Ground.</p>	<p>Identifies Gage of Hot and Ground Conductors.</p> <p>(A) = #12 AWG (B) = #10 AWG</p>	<p>Identifies Length. "L" remains constant.</p>	<p>Identifies Length of Wires (in inches) protruding out of back side of the Connector.</p>	<p>Identifies Power Direction "F" (Female) for Power "IN", "M" (Male) for Power "OUT".</p>	<p>Identifies method of securing in device. "L" for Lock Nut, "S" for Snap Ring.</p>
<u>NWC</u>	<u>2</u>	<u>2</u>	<u>2</u>	<u>A</u>	<u>L</u>	<u>12</u>	<u>F</u>	<u>S</u>											
<p>Identifies the Wire Connector.</p> <p>NWC= 120V LWC = 277V</p>	<p>Number of Circuits, also number of Hot Conductors. Insert "1" for single circuit, "2" for two-circuit, "3" for three-circuit, "4" for four-circuit, or "6" for six-circuit.</p>	<p>Identifies number of Neutral Conductors. Four (4), Conductors maximum.</p> <p>All Neutrals #10 AWG.</p>	<p>Number of Ground Conductors. Insert "1" for one System Ground or "2" for one System Ground and one Isolated Ground.</p>	<p>Identifies Gage of Hot and Ground Conductors.</p> <p>(A) = #12 AWG (B) = #10 AWG</p>	<p>Identifies Length. "L" remains constant.</p>	<p>Identifies Length of Wires (in inches) protruding out of back side of the Connector.</p>	<p>Identifies Power Direction "F" (Female) for Power "IN", "M" (Male) for Power "OUT".</p>	<p>Identifies method of securing in device. "L" for Lock Nut, "S" for Snap Ring.</p>											

<u>NWC</u>	<u>2</u>	<u>2</u>	<u>2</u>	<u>A</u>	<u>L</u>	<u>12</u>	<u>F</u>	<u>S</u>
<p>Identifies the Wire Connector.</p> <p>NWC= 120V LWC = 277V</p>	<p>Number of Circuits, also number of Hot Conductors. Insert "1" for single circuit, "2" for two-circuit, "3" for three-circuit, "4" for four-circuit, or "6" for six-circuit.</p>	<p>Identifies number of Neutral Conductors. Four (4), Conductors maximum.</p> <p>All Neutrals #10 AWG.</p>	<p>Number of Ground Conductors. Insert "1" for one System Ground or "2" for one System Ground and one Isolated Ground.</p>	<p>Identifies Gage of Hot and Ground Conductors.</p> <p>(A) = #12 AWG (B) = #10 AWG</p>	<p>Identifies Length. "L" remains constant.</p>	<p>Identifies Length of Wires (in inches) protruding out of back side of the Connector.</p>	<p>Identifies Power Direction "F" (Female) for Power "IN", "M" (Male) for Power "OUT".</p>	<p>Identifies method of securing in device. "L" for Lock Nut, "S" for Snap Ring.</p>

NOTE: See available wiring configuration options on page 7.

Walkerflex System Components (Continued)

Catalog No.

Item/Description/Specifications

Power Tap

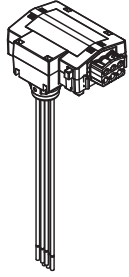

All taps are interface components that connect the flex system to an item that is to be energized, such as raised floor boxes, power poles, and lighting fixtures. Power Taps are for 120V & 277V applications with standard 8" leads on the end. Not available in 8-10 wire configurations.

Example: NPT18B111

<u>NPT</u>	<u>18</u>	<u>B</u>	<u>1</u>	<u>1</u>	<u>1</u>
Identifies the Power Tap. NPT = 120V LPT = 277V	Identifies the Size of Wires. 18 = #18AWG 12 = #12AWG	Egress Options. B = Bottom Egress S = Side Egress	Identifies Number of Hot Conductors 1 = Single Circuit 2 = Two Circuits 3 = Three Circuits	Identifies Number of Neutral Conductors Two (2) Conductors maximum	Identifies Number of Grounds 1 = System Ground 2 = System Ground & Isolated Ground

Cable Whip

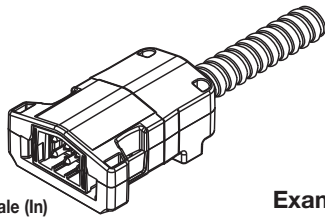

Female (In)

Carries Power from distribution unit to other components in flex system. Standard lengths: 1, 5, 10, 15, 20, 25, 30, 40, and 50 ft. [305mm, 1.52m, 3.05m, 4.57m, 7.62m, 9.14m, 12.19m, and 15.24m]. Consult factory for all other lengths. Cable Whips have a modular connector on one end and pigtails on the other end. Coded "M" (male) for power "OUT" or "F" (female) for power "IN".

Example: NCW111AL10F

<u>NCW</u>	<u>1</u>	<u>1</u>	<u>1</u>	<u>A</u>	<u>L</u>	<u>1 0</u>	<u>F</u>
Identifies the Cable Whip. NCW = 120V LCW = 277V	Number of Circuits, also number of Hot Conductors, insert "1" for single circuit, "2" for two-circuit, "3" for three-circuit, "4" for four-circuit, or "6" for six-circuit.	Identifies Number of Neutral Conductors, Four (4) Conductors maximum. All Neutrals #10 AWG.	Number of Ground Conductors, insert "1" for one System Ground, or "2" for one System Ground and one Isolated Ground.	Identifies Gage of Hot and Ground Conductors. (A) = #12 AWG (B) = #10 AWG	"L" stands for Length, remains constant.	Length of MC Cable in feet.	Insert "M" for Power Out or "F" for Power In.

NOTE: See available wiring configuration options on page 7.

Cable Splitter

Used to split one or more circuits so that it can be used in more than one direction from a given point.

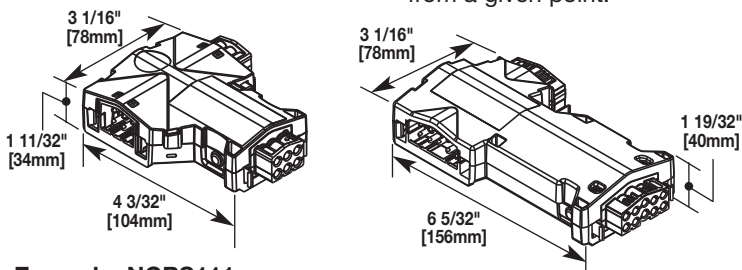

Example: NCBS111

<u>NCBS</u>	<u>1</u>	<u>1</u>	<u>1</u>
Identifies the Cable Splitter Unit. NCBS = 120V LCBS = 277V	Number of Hot Conductors. Insert "1" for single circuit, "2" for two-circuit, "3" for three-circuit, "4" for four-circuit, or "6" for six-circuit.	Identifies Number of Neutral Conductors, Four (4) Conductors maximum. All Neutrals #10 AWG.	Number of Ground Conductors. Insert "1" for one System Ground, or "2" for one System Ground and one Isolated Ground.

NOTE: See available wiring configuration options on page 7.

Walkerflex System Components (Continued)

Catalog No.	Item/Description/Specifications
-------------	---------------------------------

Cable Sets

Carries power from distribution unit to other components in flex system. Standard lengths: 1, 5, 10, 15, 25, 30, 40, and 50 ft. [305mm, 1.52m, 3.05m, 4.57m, 7.62m, 9.14m, 12.19m, 15.24m]. Consult factory for all other lengths. Cable set can have a plug on both ends. Coded "M" (Male) on one end ("Power Out") and coded "F" (Female) on the other end ("Power In") which allows proper connections.

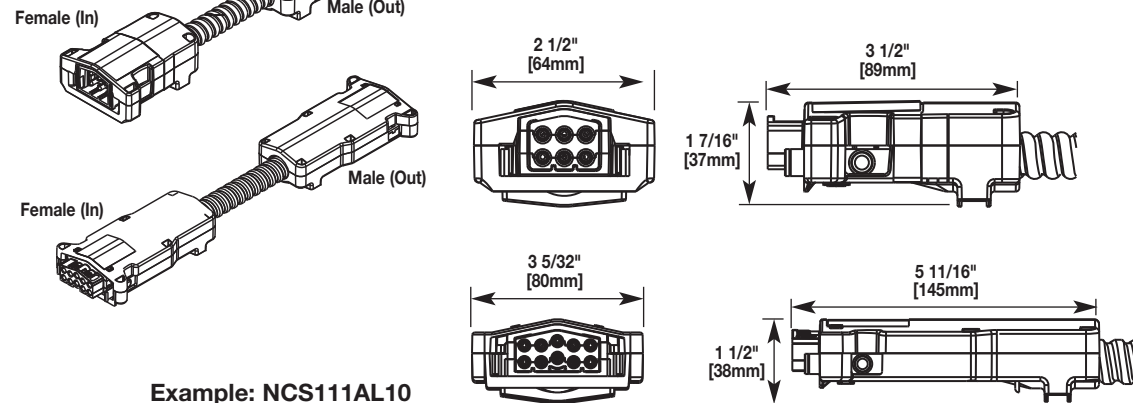

Example: NCS111AL10

NCS	1	1	1	A	L	1 0
Identifies the Cable Set NCS = 120V LCS = 277V	Number of Hot Conductors. Insert "1" for single circuit, "2" for two-circuit, "3" for three-circuit, "4" for four-circuit, or "6" for six-circuit.	Identifies Number of Neutral Conductors, Four (4) Conductors maximum. All Neutrals #10 AWG.	Number of Ground Conductors. Insert "1" for one System Ground, or "2" for one System Ground and one Isolated Ground.	Identifies Gage of Hot and Ground Conductors. (A) = #12 AWG (B) = #10 AWG	"L" stands for Length, remains constant.	Length of MC Cable in feet.

NOTE: See available wiring configuration options on page 7.

Power Adapters

All adapters are interface components that connect the flex system to an item that is to be energized, such as raised floor boxes, power poles, convenience outlets and various lighting fixtures. Power adapters are for 120V & 277V, 20A applications with a standard 8' [2.4m] MC cable whip and 12" [305mm] leads on the end. Not available in 8-10 wire.

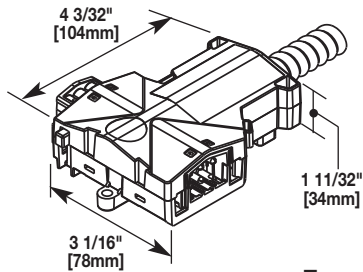

Example: NPA222AL15

NOTE: Only available in up to 6-wire configurations.

NPA	2	2	2	A	L	1 5
Identifies the Power Adapter NPA = 120V LPA = 277V	Number of Circuits, Also Number of Hot Conductors. Insert "1" for single circuit, "2" for two-circuit.	Identifies Number of Neutral Conductors, Two (2) Conductors maximum. All Neutrals #10 AWG.	Number of Ground Conductors. Insert "1" for one System Ground, or "2" for one System Ground and one Isolated Ground.	Identifies Gage of Hot and Ground Conductors. (A) = #12 AWG (B) = #10 AWG	"L" stands for Length, remains constant.	Length of MC Cable in feet.

NOTE: See available wiring configuration options on page 7.

Walkerflex System Components (Continued)

Catalog No.

Item/Description/Specifications

Modular Power Adapter

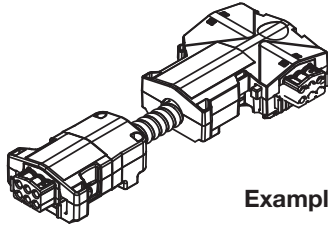

All adapters are interface components that connect the flex system to an item that is to be energized, such as raised floor boxes, power poles, convenience outlets and various lighting fixtures. Power adapters are for 120V & 277V, 20A applications with a male "Power Out" head at one end and the power adapter at the other end.

NOTE: Only available in up to 6-wire configurations.

Example: NPA222AL10M

<u>NPA</u>	<u>2</u>	<u>2</u>	<u>2</u>	<u>A</u>	<u>L</u>	<u>10</u>	<u>M</u>
Identifies the Power Adapter NPA = 120V LPA = 277V	No. of Circuits, also No. of Hot Conductors. Insert "1" for single circuit, "2" for two-circuit, "3" for three-circuit.	Identifies No. of Neutral Conductors, Two (2) Conductors maximum. All Neutrals #10 AWG.	Number of Ground Conductors. Insert "1" for one System Ground, or "2" for one System Ground and one Isolated Ground.	Identifies Gage of Hot and Ground Conductors. (A) = #12 AWG (B) = #10 AWG	"L" stands for Length, remains constant.	Length of MC Cable in feet.	M = Male Power Out

NOTE: See available wiring configuration options on page 7.

Walkerflex Wiring Configurations

3-6 WIRE CONFIGURATION

KEY COLOR	WIRING CONFIGURATION	WIRING VOLTAGE	H	N	G
BLACK	111	120V	1	1	1
	211	120V	2	1	1
	311	120V	3	1	1
ORANGE	112	120V/IG	1	1	2
	212	120V/IG	2	1	2
	222	120V/IG	2	2	2
NATURAL	221	120V/2N	2	2	1
YELLOW	111	277V	1	1	1
	211	277V	2	1	1
	311	277V	3	1	1
GREEN	112	277V/IG	1	1	2
	212	277V/IG	2	1	2
	222	277V/IG	2	2	2
BLUE	221	277V/2N	2	2	1

8-10 WIRE CONFIGURATION

KEY COLOR	WIRING CONFIGURATION	WIRING VOLTAGE	H	N	G
BLACK	422	120V	4	2	2
ORANGE	442	120V/IG	4	4	2
NATURAL	332	120V	3	3	2
BLUE	631	120V	6	3	1
IVORY	622	120V	6	2	2

Prewired Raised Floor Boxes

AF2 and AF4

AF2 and AF4 prewired raised floor/raised stage boxes have been designed to work with power, communications and AV devices. The housings are made from die-cast aluminum material with a polycarbonate cover and flange assembly. Comes with a 1 ft. modular Walkerflex power adapter.

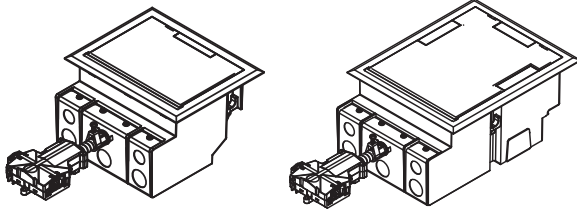

AF2 & AF4 Prewired Raised Floor Boxes.

DESCRIPTION	DIMENSIONS	
	AF2	AF4
Overall Trim Ring	8 3/4" x 6 3/4" [222mm x 171mm]	9 1/8" x 11" [232mm x 279mm]
Module Depth	5" [127mm]	5" [127mm]
Panel Opening	8" x 6" [203mm x 152mm]	8" x 10" [203mm x 254mm]
Cover Size	7 1/2" x 5" [191mm x 127mm]	7 1/2" x 9 1/2" [191mm x 242mm]
Activation Chamber	130 cu in. [2130ml]	220 cu in. [3604ml]
User Volume	78.6 cu in. [1288ml]	180 cu in. [2948ml]
Total Volume	208.6 cu in. [3418ml]	300 cu in. [4915ml]
Knockout Sizes	Seven (7) 1/2" & Two (2) 3/4" Trade Size KOs (Power Side only)	Seven (7) 1/2" & Two (2) 3/4" Trade Size KOs (Power Side only)
Depth Behind Plate	2 3/4" [69.8mm]	2 3/4" [69.8mm]
Service	Triple	Triple
Capacity	4 Gangs	8 Gangs
Connectivity	6 Ports Unloaded	12 Ports Unloaded
Max. Floor Thickness	1 1/2" [38mm] (floor covering included)	1 1/2" [38mm] (floor covering included)

AF2	K	C	2	111	PA
AF Series: AF2 or AF4	Cover Color: K = Black Y = Gray N = Brown	Cover Insert: C = Carpet Insert T = Tile (No Insert)	No. of Receptacles: 2 = 2 Receptacles 4 = 4 Receptacles	Power Delivery System: 111 = 1 Circuit, 1 Neutral, System Ground 222 = 2 Circuits, 2 Neutrals, Isolated Ground	Style of Feed: PA = Power Adapter

Standard Product Offerings: AF2

AF2KC2111PA	AF2KC2222PA	AF2KC4222PA
AF2YC2111PA	AF2YC2222PA	AF2YC4222PA
AF2NC2111PA	AF2NC2222PA	AF2NC4222PA
AF2KT2111PA	AF2KT2222PA	AF2KT4222PA
AF2YT2111PA	AF2YT2222PA	AF2YT4222PA
AF2NT2111PA	AF2NT2222PA	AF2NT4222PA

Standard Product Offerings: AF4

AF4KC2111PA	AF4KC2222PA	AF4KC4222PA
AF4YC2111PA	AF4YC2222PA	AF4YC4222PA
AF4NC2111PA	AF4NC2222PA	AF4NC4222PA
AF4KT2111PA	AF4KT2222PA	AF4KT4222PA
AF4YT2111PA	AF4YT2222PA	AF4YT4222PA
AF4NT2111PA	AF4NT2222PA	AF4NT4222PA

SAF

SAF prewired shallow raised floor/raised stage boxes have been designed to work with power, communications and AV devices in a minimum 2 1/2" deep floor. The housings are made from formed galvanized steel with a polycarbonate cover and flange assembly. Comes with a 1 ft. modular Walkerflex power adapter.

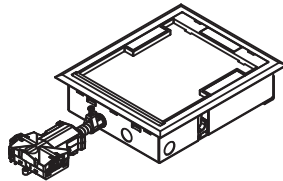

DESCRIPTION	DIMENSIONS
Overall Trim Ring	9 1/8" x 11" [232mm x 279mm]
Module Depth Overall	2.5" [64mm]
Panel Opening	8" x 10" [203mm x 254mm]
Cover Size	7 1/2" x 9 1/2" [191mm x 242mm]
Activation Volume	18.5 cu in. [303ml]
Power Volume	29 cu in. [475ml]
Maximum Floor Panel Thickness with Floor Covering	1 3/16" [30mm]
Knockout Sizes	Power – Four (4) 1/2"-3/4" Trade Size Concentric KOs Communication – Two (2) 1/2"-3/4" Trade Size Concentric KOs
Depth Behind Plate	2" [51mm]
Service	Triple
Capacity	3 Gangs
Connectivity	6 Ports Unloaded
Max. Floor Thickness	1 3/8" [35mm] (floor covering included)

Standard Product Offerings: CESAF

SAFKC2111PA	SAFKC2222PA
SAFYC2111PA	SAFYC2222PA
SAFNC2111PA	SAFNC2222PA
SAFKT2111PA	SAFKT2222PA
SAFYT2111PA	SAFYT2222PA
SAFNT2111PA	SAFNT2222PA

SAF	K	C	2	111	PA
SAF Series	Cover Color: K = Black Y = Gray N = Brown	Cover Insert: C = Carpet Insert T = Tile (No Insert)	No. of Receptacles: 2 = 2 Receptacles	Power Delivery System: 111 = 1 Circuit, 1 Neutral, System Ground 222 = 2 Circuits, 2 Neutrals, Isolated Ground	Style of Feed: PA = Power Adapter

Prewired Raised Floor Boxes (continued)

AC8840

AC8840 single-service, prewired raised floor/raised stage boxes. The AC8840 is an 8" x 8" [203mm x 203mm] box that has been designed to work with power devices in a minimum 4" [102mm] deep floor. The housings are made from formed galvanized steel with a die-cast aluminum cover and flange assembly. Comes with a 1 ft. modular Walkerflex power adapter.

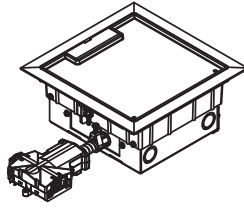

DESCRIPTION	DIMENSIONS
Box Dimensions	8" x 8" x 4" [203mm x 203mm x 102mm]
Overall Trim Ring	9 1/4" x 9 1/4" [235mm x 235mm]
Module Depth	4" [102mm]
Panel Opening	8" x 8" [203mm x 203mm]
Cover Size	7 11/16" x 7 11/16" [195mm x 195mm]
Activation Chamber	63.92 cu in. [1047ml]
User Volume	84.34 cu in. [1382ml]
Total Volume	152.34 cu in. [2496ml]
Knockout Sizes	Power – Four (4) 1/2"-3/4" Trade Size Concentric KOs Communication – Two (2) 1/2"-3/4" Trade Size Concentric KOs
Depth Behind Plate	2" [51mm]
Service	Single
Capacity	4 Gangs
Max. Floor Thickness	2" [51mm] (floor covering included)

Standard Product Offerings: AC8840
AC8840YC2111PA
AC8840YC2222PA

AC	88	40	Y	C	2	111	PA
AC Series	Cover Size: 88 = 8" x 8"	Box Depth: 40 = 4" Deep	Cover Color: Y = Gray	Cover Insert: C = Carpet Insert T = Tile (No Insert)	No. of Receptacles: 2 = 2 Receptacles	Power Delivery System: 111 = 1 Circuit, 1 Neutral, System Ground 222 = 2 Circuits, 2 Neutrals, Isolated Ground	Style of Feed: PA = Power Adapter

AC8850

AC8850 single service prewired raised floor/raised stage boxes. The AC8850 is an 8" x 8" [203mm x 203mm] box that has been designed to work with power or communications devices in a minimum 5" [127mm] deep floor. The housings are made from formed galvanized steel with a die-cast aluminum cover and flange assembly. Comes with a 1 ft. modular Walkerflex power adapter.

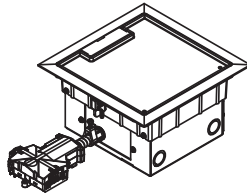

DESCRIPTION	DIMENSIONS
Box Dimensions	8" x 8" x 5" [203mm x 203mm x 127mm]
Overall Trim Ring	9 1/4" x 9 1/4" [235mm x 235mm]
Module Depth	5" [127mm]
Panel Opening	8" x 8" [203mm x 203mm]
Cover Size	7 11/16" x 7 11/16" [195mm x 195mm]
Activation Chamber	97.22 cu in. [1593ml]
User Volume	102.22 cu in. [1674ml]
Total Volume	199.22 cu in. [3264ml]
Knockout Sizes	Power – Four (4) 1/2"-3/4" Trade Size Concentric KOs Communication – Four (4) 1/2"-3/4" Trade Size Concentric KOs
Depth Behind Plate	2" [51mm]
Service	Single
Capacity	4 Gangs
Max. Floor Thickness	2" [51mm] (floor covering included)

Standard Product Offerings: AC8850
AC8850YC2111PA
AC8850YC2222PA
AC8850YC42222PA

AC	88	50	Y	C	2	111	PA
AC Series	Cover Size: 88 = 8" x 8"	Box Depth: 50 = 5" Deep	Cover Color: Y = Gray	Cover Insert: C = Carpet Insert	No. of Receptacles: 2 = 2 Receptacles 4 = 4 Receptacles	Power Delivery System: 111 = 1 Circuit, 1 Neutral, System Ground 222 = 2 Circuits, 2 Neutrals, Isolated Ground	Style of Feed: PA = Power Adapter

Prewired Raised Floor Boxes (continued)

AC8104

AC8104 prewired raised floor/raised stage boxes. The AC8104 is an 8" x 10" [203mm x 254mm] box that has been designed to work with power and communications devices in a minimum 4" [102mm] deep floor. The housings are made from formed galvanized steel with a die-cast aluminum cover and flange assembly. Comes with a 1 ft. modular Walkerflex power adapter.

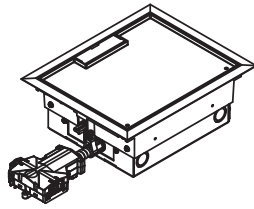

Standard Product Offerings: AC8104
 AC8104YC2111PA
 AC8104YC2222PA

DESCRIPTION	DIMENSIONS
Box Dimensions	8" x 10" x 4" [203mm x 254mm x 102mm]
Overall Trim Ring	9 1/4" x 11 1/4" [235mm x 286mm]
Module Depth	4" [102mm]
Panel Opening	8" x 10" [203mm x 254mm]
Cover Size	7 11/16" x 9 11/16" [195mm x 246mm]
Activation Chamber	76.87 cu in. [1593ml]
User Volume	130.09 cu in. [2131ml]
Total Volume	201.09 cu in. [3295ml]
Knockout Sizes	Power – Four (4) 1/2"-3/4" Trade Size Concentric KOs Communication – Four (4) 1/2"-3/4" Trade Size Concentric KOs
Depth Behind Plate	1 3/4" [44mm]
Service	Dual
Capacity	6 Gangs
Connectivity	12 Ports Unloaded
Max. Floor Thickness	2" [51mm] (floor covering included)

<u>AC</u>	<u>810</u>	<u>4</u>	<u>Y</u>	<u>C</u>	<u>2</u>	<u>111</u>	<u>PA</u>
AC Series	Cover Size: 810 = 8" x 10"	Box Depth: 4 = 4" Deep	Cover Color: Y = Gray	Cover Insert: C = Carpet Insert	No. of Receptacles: 2 = 2 Receptacles	Power Delivery System: 111 = 1 Circuit, 1 Neutral, System Ground 222 = 2 Circuits, 2 Neutrals, Isolated Ground	Style of Feed: PA = Power Adapter

AC8105

AC8105 Convia-enabled prewired raised floor/raised stage boxes. The AC8105 is an 8" x 10" [203mm x 254mm] box that has been designed to work with power, communications and audio visual devices in a minimum 5" [127mm] deep floor. The housings are made from formed galvanized steel with a die-cast aluminum cover and flange assembly. Comes with a 1 ft. modular Walkerflex power adapter.

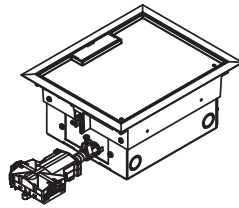

Standard Product Offerings: AC8105
 AC8105YC2111PA
 AC8105YC2222PA
 AC8105YC4222PA

DESCRIPTION	DIMENSIONS
Box Dimensions	8" x 10" x 5" [203mm x 254mm x 127mm]
Overall Trim Ring	9 1/4" x 11 1/4" [235mm x 286mm]
Module Depth	5" [127mm]
Panel Opening	8" x 10" [203mm x 254mm]
Cover Size	7 11/16" x 9 11/16" [195mm x 246mm]
Activation Chamber	111.08 cu in. [1820ml]
User Volume	151.97 cu in. [2490ml]
Total Volume	262.97 cu in. [4309ml]
Knockout Sizes	Power – Four (4) 1/2"-3/4" Trade Size Concentric KOs Communication – Four (4) 1/2"-3/4" Trade Size Concentric KOs
Depth Behind Plate	2" [51mm]
Service	Triple
Capacity	6 Gangs
Communication Device	18 Ports Unloaded
Max. Floor Thickness	2" [51mm] (floor covering included)

<u>AC</u>	<u>810</u>	<u>5</u>	<u>Y</u>	<u>C</u>	<u>2</u>	<u>111</u>	<u>PA</u>
AC Series	Cover Size: 810 = 8" x 10"	Box Depth: 5 = 5" Deep	Cover Color: Y = Gray	Cover Insert: C = Carpet Insert	No. of Receptacles: 2 = 2 Receptacles 4 = 4 Receptacles	Power Delivery System: 111 = 1 Circuit, 1 Neutral, System Ground 222 = 2 Circuits, 2 Neutrals, Isolated Ground	Style of Feed: PA = Power Adapter

Prewired Raised Floor Boxes (continued)

AC10105

AC10105 prewired raised floor/raised stage boxes. The AC10105 is an 10" x 10" [203mm x 254mm] box that has been designed to work with power, communications and audio visual devices in a minimum 5" [127mm] deep floor. The housings are made from formed galvanized steel with a die-cast aluminum cover and flange assembly. Comes with a 1 ft. modular Walkerflex power adapter.

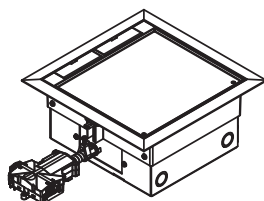

DESCRIPTION	DIMENSIONS
Box Dimensions	10" x 10" x 5" [254mm x 254mm x 127mm]
Overall Trim Ring	11 1/2" x 11 1/2" [292mm x 292mm]
Module Depth	5" [127mm]
Panel Opening	10" x 10" [254mm x 254mm]
Cover Size	9 5/8" x 9 5/8" [245mm x 245mm]
Activation Chamber	115 cu in. [1884ml]
User Volume	243 cu in. [3981ml]
Total Volume	358 cu in. [5865ml]
Knockout Sizes	Power – Four (4) 1/2" Trade Size Concentric KOs Communication – Four (4) 1/2"-3/4" Trade Size Concentric KOs
Depth Behind Plate	2" [51mm]
Service	Triple
Capacity	6 Gangs
Connectivity	18 Ports Unloaded
Max. Floor Thickness	2" [51mm] (floor covering included)

Standard Product Offerings: AC10105

AC10105YC2111PA
AC10105YC2222PA
AC10105YC42222PA

AC	1010	5	Y	C	2	111	PA
AC Series	Cover Size: 1010 = 10" x 10"	Box Depth: 5 = 5" Deep	Cover Color: Y = Gray	Cover Insert: C = Carpet Insert	No. of Receptacles: 2 = 2 Receptacles 4 = 4 Receptacles	Power Delivery System: 111 = 1 Circuit, 1 Neutral, System Ground 222 = 2 Circuits, 2 Neutrals, Isolated Ground	Style of Feed: PA = Power Adapter

CRFB

Prewired round raised floor/raised stage boxes. Die-cast aluminum unit available in black or gray and comes with a solid cover or a cover that has an insert area to accept the floor covering. The CRFB has been designed to work with power, communication, and A/V devices in a minimum 6 1/2" [165mm] deep floor. Comes with a 1 ft. modular Walkerflex power adapter.

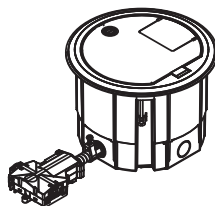

DESCRIPTION	DIMENSIONS
Box Dimensions	9 1/2" [241mm] Diameter x 6 5/8" [168mm] Tall
Overall Trim Ring	9 1/2" [241mm] Diameter
Module Depth	3 3/4" [95mm]
Panel Opening	9 1/2" [241mm]
Cover Size	9 1/4" [235mm] Diameter
Activation Chamber:	
Chambers 1 and 2	23.5 cu in. [385ml]
Chamber 3	17.5 cu in. [287ml]
Chamber 4	32.8 cu in. [538ml]
User Volume	30 cu in. [762ml]
Total Volume	127.3 cu in. [3233ml]
Knockout Sizes	Four (4) Concentric 1/2" - 3/4" Trade Size Three (3) Concentric 3/4" - 1" Trade Size One (1) 2" Trade Size
Depth Behind Plate	2 1/4" [57mm]
Service	Triple
Capacity	4 Gangs
Communication Device	6 Ports Unloaded
Max. Floor Thickness	2" [51mm] (floor covering included)

Standard Product Offerings: CRFB

CRFBKC2111PA	CRFBKC2222PA	CRFBKC4222PA
CRFBYC2111PA	CRFBYC2222PA	CRFBYC4222PA
CRFBKT2111PA	CRFBKT2222PA	CRFBKT4222PA
CRFBYT2111PA	CRFBYT2222PA	CRFBYT4222PA

CRFB	K	C	2	111	PA
Cover Size: 7 11/16" diameter	Cover Color: K = Black Y = Gray	Cover Insert: C = Carpet Insert Cover T = Tile (solid) Cover	No. of Receptacles: 2 = 2 Receptacles 4 = 4 Receptacles	Power Delivery System: 111 = 1 Circuit, 1 Neutral, System Ground 222 = 2 Circuits, 2 Neutrals, Isolated Ground	Style of Feed: PA = Power Adapter

Evolution™ Series Poke-Thru Devices

6STCP

Recessed modular stem assembly – includes 6" [152mm] core hole poke-thru stem assembly with a disposable plate and two proprietary 20A duplex receptacles. Devices are recessed 3 1/4" [83mm] below the surface, no cover assembly included. For use with the following cover assemblies (Purchased separately): 6CTC and 6CT series. Comes with 1 ft. modular Walkerflex power adapter.

Included: For Side Compartments: Two (2) proprietary 20 AMP duplex receptacles installed. **For Center Compartment:** One (1) 6ACT8A Mounting Plate, One (1) 6TRAC Mounting Plate, and One (1) 6SER Mounting Plate. **For Bottom Feed Compartment:** One (1) 5BLH 1/2-Gang Blank Housing, One (1) 1PTHA 1-Gang Pass-Through Housing Assembly, and One (1) 575CHA 1/2-Gang 3/4" Conduit Housing Assembly.

NOTE: UL Fire Classified for up to 2 hour rated floors.

NOTE: Receptacles can be wired as a standard or isolated ground devices.

NOTE: Assembled with a scrub water gasket. For use on tile, wood or carpeted covered floors. Maximum floor covering thickness range 1" [25mm], not designed for use on bare concrete or terrazzo finished floors.

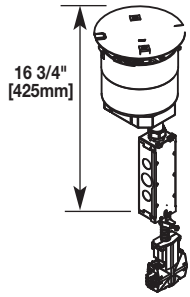

<u>6</u>	<u>S</u>	<u>TC</u>	<u>P</u>	<u>222</u>	<u>PA</u>
Diameter of Poke-Thru Device: 6 = 6" [152mm]	S = Stem Assembly	Unit is approved tile, wood, and carpet covered floors	Unit is prewired with 2 20A Duplex Receptacles installed to a Walkerflex connector	Power Delivery System: 111 = 1 Circuit, 1 Neutral, System Ground 222 = 2 Circuits, 2 Neutrals, Isolated Ground	Style of Feed: PA = Power Adapter

6STCPAV

Recessed modular stem assembly – includes 6" [152mm] core hole poke-thru stem assembly with a disposable plate and one proprietary 20A duplex receptacle. Devices are recessed 3 1/4" [83mm] below the surface, no cover assembly included. For use with the following cover assemblies (Purchased separately): 6CTC and 6CT series. Comes with 1 ft. modular Walkerflex power adapter.

Included: For Side Compartments: One (1) proprietary 20 AMP duplex receptacle installed, 682A Device Plate, and 68MAAP Device Plate. **For Center Compartment:** 6DEC Mounting Plate, 6AAP Mounting Plate, and 6MAAP Mounting Plate. **For Bottom Feed Compartment:** One (1) 5PTHA 1/2-Gang Pass-Through Housing Assembly, One (1) 1PTHA 1-Gang Pass-Through Housing Assembly, and One (1) 575CHA 1/2-Gang 3/4" Conduit Housing Assembly.

NOTE: UL Fire Classified for up to 2 hour rated floors.

NOTE: Receptacles can be wired as a standard or isolated ground device.

NOTE: Assembled with a scrub water gasket. For use on tile, wood or carpeted covered floors. Maximum floor covering thickness range 1" [25mm], not designed for use on bare concrete or terrazzo finished floors.

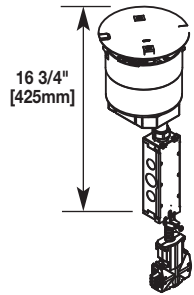

<u>6</u>	<u>S</u>	<u>TC</u>	<u>P</u>	<u>AV</u>	<u>111</u>	<u>PA</u>
Diameter of Poke-Thru Device: 6 = 6" [152mm]	S = Stem Assembly	Unit is approved tile, wood, and carpet covered floors	Unit is prewired with 1 20A Duplex Receptacle installed to a Walkerflex connector	AV = Audio/Visual	Power Delivery System: 111 = 1 Circuit, 1 Neutral, System Ground	Style of Feed: PA = Power Adapter

6ATCFF

Recessed modular stem assembly with disposable plate – includes 6" [152mm] core hole poke-thru stem assembly with a disposable plate. Devices are recessed 3 1/4" [83mm] below the surface, no cover assembly included. For use with the following cover assemblies (Purchased separately): 6CTC and 6CT series. Comes with 1 ft. modular Walkerflex cable whip.

Included For Bottom Feed Compartment: One (1) 5PTHA 1/2-Gang Pass Through Housing Assembly, One (1) 15FFHA 1/2-Gang Pass Through Housing Assembly, One (1) 575CHA 1/2-Gang 3/4" Conduit Housing Assembly

NOTE: UL Fire Classified for up to 2 hour rated floors.

NOTE: Assembled with a scrub water gasket. For use on tile, wood or carpeted covered floors. Maximum floor covering thickness range 1" [25mm], not designed for use on bare concrete or terrazzo finished floors.

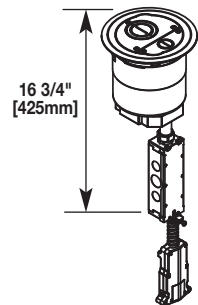

<u>6</u>	<u>A</u>	<u>TC</u>	<u>FF</u>	<u>BK</u>	<u>422</u>	<u>CW</u>
Diameter of Poke-Thru Device: 6 = 6" [152mm]	A = Assembled Unit	Unit is approved tile, wood, and carpet covered floors	Furniture Feed Style Poke-Thru Device	Color of Cover Assembly = BK = Black GY = Gray BS = Brass NK = Nickel BE = Bronze	Power Delivery System: 422 = 4 Circuits, 2 Neutrals, Isolated Ground	Style of Feed: CW = Cable Whip

Evolution™ Series Poke-Thru Devices (continued)

8STCP

Recessed modular stem assembly with disposable plate – includes 8" core hole poke-thru stem assembly with a disposable plate. Devices are recessed 3 1/4" [83mm] below the surface, no cover assembly included. For use with the following cover assemblies (Purchased separately): 8CTC and 8CT series. Comes with 1 ft. modular Walkerflex power adapter.

Included For Bottom Feed Compartments: One (1) 5PTHA 1/2-Gang Pass Through Housing Assembly, One (1) 1PTHA 1-Gang Pass Through Housing Assembly, One (1) 575CHA 1/2-gang 3/4" Conduit Housing Assembly.

NOTE: UL Fire Classified for up to 2 hour rated floors.

NOTE: Assembled with a scrub water gasket. For use on tile, wood or carpeted covered floors. Maximum floor covering thickness range 1" [25mm], not designed for use on bare concrete or terrazzo finished floors.

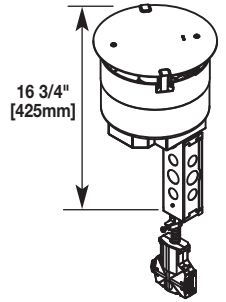

<u>8</u>	<u>S</u>	<u>TC</u>	<u>P</u>	<u>222</u>	<u>PA</u>
Diameter of Poke-Thru Device: 8 = 8" [203mm]	S = Stem Assembly	Unit is approved tile, wood, and carpet covered floors	Unit is prewired with 2 20A Duplex Receptacles installed to a Walkerflex connector	Power Delivery System: 222 = 2 Circuits, 2 Neutrals, Isolated Ground	Style of Feed: PA = Power Adapter

Surface Style Poke-Thru Devices

RC9A15TC

Surface style poke-thru assembly – Prewired 15A quad receptacle with a 1 ft. modular Walkerflex cable whip. Poke-thru unit fits into a 3" [76.2 mm] diameter core hole. Unit also includes two openings for pass through capability for one (1) 4-pair category 5e or category 6 cable per opening. Comes with 1 ft. modular Walkerflex cable whip.

Standard Offerings: RC9A15TCBK111CW, RC9A15TCGY111CW, RC9A15TCBS111CW, RC9A15TCAA111CW, RC9A15TCAL111CW, RC9A15TCAB111CW

NOTE: Assembled with a scrub water gasket. For use on tile, wood or carpeted covered floors. Floor covering thickness range 1/8" to 3/4", not designed for use on bare concrete or terrazzo finished floors.

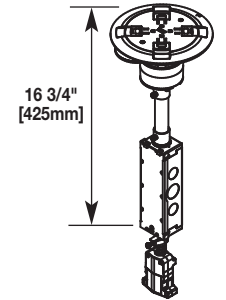

<u>RC9A</u>	<u>15</u>	<u>TC</u>	<u>BK</u>	<u>111</u>	<u>CW</u>
Surface Style Poke-Thru, Model: RC9A	15 = 15A Quad Power Receptacle	Unit is approved tile, wood, and carpet covered floors	Color of Cover Assembly: BK = Black GY = Gray AL = Aluminum BS = Brass AA = All Aluminum AB = All Brass	Power Delivery System: 111 = 1 Circuit, 1 Neutral, System Ground	Style of Feed: CW = Cable Whip

RC4ATC

Surface style poke-thru assembly – Two (2) prewired 20A proprietary receptacles with a 1 ft. modular Walkerflex connector. The duplex receptacle on the "A" side is wired to the system ground and the duplex receptacle on the "B" side is wired to isolated ground. The poke-thru unit fits into a 4" [101.6 mm] diameter core hole. Comes with 1 ft. modular Walkerflex power adapter.

Unit also includes:

- Open inserts unloaded to accept discrete keystone connectors from most manufacturers
- Ortronics Tracjacks mounting bezel
- Ortronics Series II communication housing

Standard Offerings: RC4ATCBK222PA, RC4ATCGY222PA, RC4ATCBS222PA, RC4ATCAL222PA, RC4ATCAA222PA, RC4ATCAB222PA

NOTE: Assembled with a scrub water gasket. For use on tile, wood or carpeted covered floors. Floor covering thickness range 1/8" to 3/4", not designed for use on bare concrete or terrazzo finished floors. Modular Jacks sold separately.

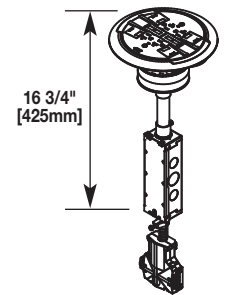

<u>RC4</u>	<u>A</u>	<u>TC</u>	<u>BK</u>	<u>222</u>	<u>PA</u>
Surface Style Poke-Thru, Model: RC4	A = Assembled Unit	Unit is approved tile, wood, and carpet covered floors	Color of Cover Assembly: BK = Black GY = Gray AL = Aluminum BS = Brass AA = All Aluminum AB = All Brass	Power Delivery System: 222 = 2 Circuits, 2 Neutrals, Isolated Ground	Style of Feed: PA = Power Adapter

Surface Style Poke-Thru Devices (continued)

AV3ATC

Surface style AV poke-thru assembly – One (1) prewired 20A proprietary receptacle with a 1 ft. modular Walkerflex power adapter. The poke-thru unit fits into a 4" [101.6mm] diameter core hole.

Unit also includes:

- One (1) Extron adapter to accept Extron MAAP mini architectural adapter plates. (Extron devices sold separately, only through authorized Extron dealers).
- One (1) Wiremold open system adapter and inserts unloaded to accept discrete keystone connectors from most manufacturers
- One (1) Ortronics Tracjacks adapter
- One (1) Ortronics Series II adapter

Standard Offerings: AVATCBK111PA, AV3ATCGY111PA, AV3ATCBS111PA, AV3ATCAL111PA, AV3ATCAA111PA, AV3ATCAB111PA

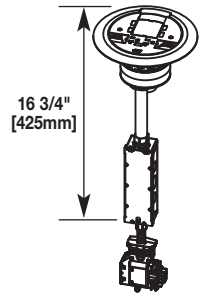

NOTE: Assembled with a scrub water gasket. For use on tile, wood or carpeted covered floors. Floor covering thickness range 1/8" to 3/4", not designed for use on bare concrete or terrazzo finished floors. Modular Jacks sold separately.

<u>AV3</u>	<u>A</u>	<u>TC</u>	<u>BK</u>	<u>111</u>	<u>PA</u>
Surface Style Poke-Thru, Model: AV3	A = Assembled Unit	Unit is approved tile, wood, and carpet covered floors	Cover Assembly Color: BK = Black GY = Gray AL = Aluminum BS = Brass AA = All Aluminum AB = All Brass	Power Delivery System: 111 = 1 Circuit, 1 Neutral, System Ground	Style of Feed: PA = Power Adapter

RC7ATC

Surface style poke-thru assembly – One (1) prewired 20A proprietary receptacle with a 1 ft. modular Walkerflex cable whip. The Poke-thru unit fits into a 3" [76.2 mm] diameter core hole.

Unit also includes:

- One (1) Wiremold open system adapter and inserts unloaded to accept discrete keystone connectors from most manufacturers
- Two (2) Cat. 6 TechChoice discrete keystone modular jacks
- One (1) Ortronics Tracjack adapter

Standard Offerings: RC7ATCBK111CW, RC7ATCGY111CW, RC7ATCBS111CW, RC7ATCAL111CW, RC7ATCAA111CW, RC7ATCAB111CW

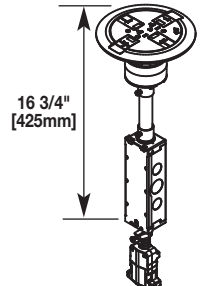

NOTE: Assembled with a scrub water gasket. For use on tile, wood or carpeted covered floors. Floor covering thickness range 1/8" to 3/4", not designed for use on bare concrete or terrazzo finished floors.

<u>RC7</u>	<u>A</u>	<u>TC</u>	<u>BK</u>	<u>111</u>	<u>CW</u>
Surface Style Poke-Thru, Model: RC7	A = Assembled Unit	Unit is approved tile, wood, and carpet covered floors	Cover Assembly Color: BK = Black GY = Gray AL = Aluminum BS = Brass AA = All Aluminum AB = All Brass	Power Delivery System: 111 = 1 Circuit, 1 Neutral, System Ground	Style of Feed: CW = Cable Whip

Furniture Feed Poke-Thru Devices

4FFATC

Furniture feed style poke-thru assembly – Complete with one-piece finish flange and conduit assembly. Finish covers flange provided with one (1) 3/4" trade size screw plug opening and one (1) 1 1/4" trade size screw plug opening. The poke-thru unit fits into a 4" [102 mm] diameter core hole. Comes with 1 ft. modular Walkerflex cable whip.

Unit also includes:

- One (1) 3/4" trade size conduit adapter.
- One (1) 1 1/4" trade size conduit adapter.

Standard Offerings: 4FFATCBK422CW, 4FFATCGY422CW, 4FFATCBS422CW, 4FFATCAL422CW,

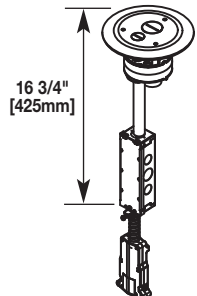

NOTE: Assembled with a scrub water gasket. For use on tile, wood or carpeted covered floors. Floor covering thickness range 1/8" to 3/4", not designed for use on bare concrete or terrazzo finished floors.

<u>4FF</u>	<u>A</u>	<u>TC</u>	<u>BK</u>	<u>422</u>	<u>CW</u>
4FF = Furniture Feed Style Poke-Thru Device	A = Assembled Unit	Unit is approved tile, wood, and carpet covered floors	Cover Assembly Color: BK = Black GY = Gray AL = Aluminum BS = Brass	Power Delivery System: 422 = 4 Circuits, 2 Neutrals, Isolated Ground	Style of Feed: CW = Cable Whip

Surface Style Poke-Thru Series Specifications

Copper Cross Section:

The copper cross-sectional area determines the amount of wire fill capacity in a poke-thru device. Unlike other wire and cable management systems that utilize wire fill capacity, a poke-thru device is UL tested under fire conditions to determine the maximum amount of copper conductors that will pass through a poke-thru device, while maintaining the fire-rating of the floor assembly. All Walker Flush Style Devices are UL Classified to U.S. and Canadian safety standards (see complete marking on product) to accommodate at a maximum rating as follows:

RC7 SERIES

Maximum Allowable Copper Cross-Sectional Area:

RC7 Power Compartment Only = .01536 sq. in. [9.91mm²]

RC7 Each Communication Compartment Only = .0040 sq. in. [2.58mm²]

NOTE: The RC7 Series requires a 3" [76mm] cored hole.
(American made core bit having an outside diameter of 3 1/16" [78mm].)

RC9 SERIES

Maximum Allowable Copper Cross-Sectional Area:

RC9 Power Compartment Only = .01536 sq. in. [9.91mm²]

RC9 Each Communication Compartment Only = .0040 sq. in. [2.58mm²]

NOTE: The RC9 Series requires a 3" [76mm] cored hole.
(American made core bit having an outside diameter of 3 1/16" [78mm].)

AV3 SERIES

Maximum Allowable Copper Cross-Sectional Area:

AV3 Power Compartment Only = .01536 sq. in. [9.91mm²]

AV3 Communication Compartment Only = .01938 sq. in. [12.503mm²]

NOTE: The AV3 Series requires a 4" [102mm] cored hole.
(American made core bit having an outside diameter of 4 1/16" [103mm].)

RC4 SERIES

Maximum Allowable Copper Cross-Sectional Area:

RC4 Power Compartment Only = .03072 sq. in. [19.82mm²]

RC4 Each Communication Compartment Only = .008 sq. in. [5.16mm²]

NOTE: The RC4 Series requires a 4" [102mm] cored hole.
(American made core bit having an outside diameter of 4 1/16" [103mm].)

IMPORTANT!

The above maximum copper cross sectional area values are for each individual power and communication compartment. **DO NOT** add values together for any one compartment.

CAUTION! Core bits vary in size from manufacturer to manufacturer:

- Use a 3" [76mm] American made core bit having an outside diameter of 3 1/16" [78mm]. Minimum hole diameter: 3 1/16" [78mm].
- Use a 4" [102mm] American made core bit having an outside diameter of 4 1/16" [103mm]. Minimum hole diameter: 4 1/16" [103mm].

CAUTION: These devices are suitable for 1, 1 1/2, and 2 hour rated floor assemblies as described in the UL Fire Resistance directory for each service.

These devices meet all UL scrub water requirements, but are not suitable for wet or damp locations, or other areas subject to saturation with water or other liquids such as commercial kitchens.

Copper Cross Sectional Area of Commonly Used Conductors

Size	Solid	
#24	.00032 sq. in.	[.206mm ²]
#22	.00050 sq. in.	[.322mm ²]
#14	.00323 sq. in.	[2.083mm ²]
#12	.00512 sq. in.	[3.303mm ²]
#10	.00815 sq. in.	[5.258mm ²]
# 8	.01296 sq. in.	[8.361mm ²]

NOTE: Use above values for solid or stranded conductors.

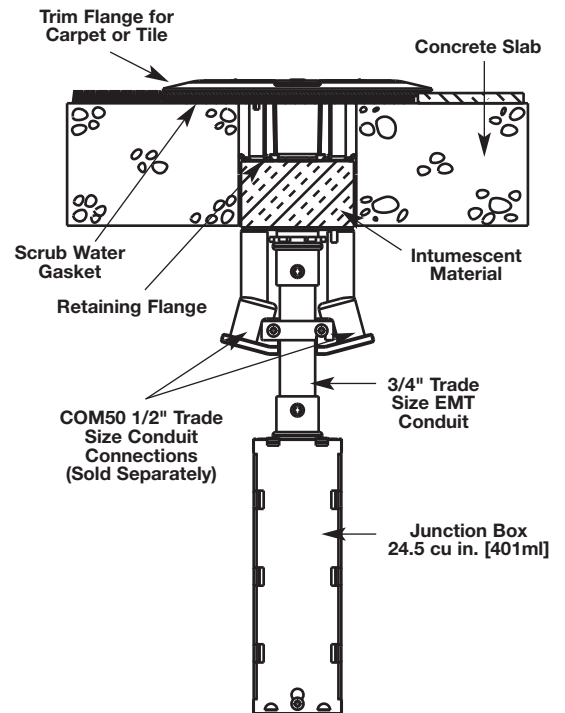

Concrete Thickness Min/Max:

1-HOUR RATED FLOOR – 2 1/4" [57mm] min over top of deck (or 3" [76mm] thick reinforced concrete slab) to a maximum of 7 1/2" [191mm].

2-HOUR RATED FLOOR – 3 1/4" [83mm] min over top of deck (or 4" [102mm] thick reinforced concrete slab) to a maximum of 7 1/2" [191mm].

Floor Coverings:

The poke-thru device is fire rated for carpet and wood covered concrete floors, and tile floor coverings 1/8" to 3/4" [3.2mm to 19.1mm] thickness. For floor coverings not listed above, consult factory.



Wiremold

WIREMOLD

U.S. and International:

60 Woodlawn Street • West Hartford, CT 06110
1-800-621-0049 • FAX 860-232-2062 • Outside U.S. 860-233-6251

Canada:

570 Applewood Crescent • Vaughan, Ontario L4K 4B4
1-800-723-5175 • FAX 905-738-9721

