



Commercial Swimming Pools



Why Paddock?

...Because we have led the way in the swimming pool industry for **nearly a century**, from the first backyard pools for movie stars in the early days, to today's modern multipurpose aquatic center. What's the reason? It's simple: we take a **unique approach that focuses on the complete project—and the owner's complete satisfaction**. No other company knows pools like we do, and no other company has the capability we have to do it all, start to finish.

This is why we take our vision so seriously, to create **the nation's most distinctive aquatic facilities**—stunning pools that perform at the highest level and exceed expectations. Paddock is not just another equipment manufacturer, but a full service company dedicated to achieving the best results. Contact us in the early planning phases to benefit most from our expertise, as we can help you to design, equip, and construct the aquatic facility that meets your unique requirements.

Visit our website to learn more about the broad range of services we offer for projects of all kinds, such as world-class competition venues, YMCAs, municipal pools, military installations, family water parks, health & fitness centers, private clubs, and more.

www.paddockpool.com
1.800.849.2729



Design

Paddock offers design assistance to any interested owner, architect, or consultant. Our AutoCAD Inventor drawings are prepared for the individual project and include layouts in various views, product details, and complete equipment lists, with specifications available for all items.

With literally **thousands of commercial pools to our credit** since the early 1960's, Paddock is uniquely qualified to assist you with the layout of any facility. We're familiar with the appropriate codes nationwide, and we understand the design requirements demanded by coaches, instructors, recreation directors, and therapists. We know what works, and what doesn't.

Integration of custom manufactured equipment for the specific intended use of the pool is the hallmark of Paddock designs. For instance, is saving space an issue? Is there a need for speed? Or, are you more concerned with aesthetics? Safety? Functional flexibility? Our interest is in providing you with the pool that best suits your purposes—down to the last detail.

Our design assistance service includes **budgeting and coordination of related trades** such as electrical, plumbing, etc. We specialize in finding solutions to meet any design challenge. Contact Paddock before you begin your new pool project or major renovation. We want to be your partner in helping create a truly outstanding aquatic facility.

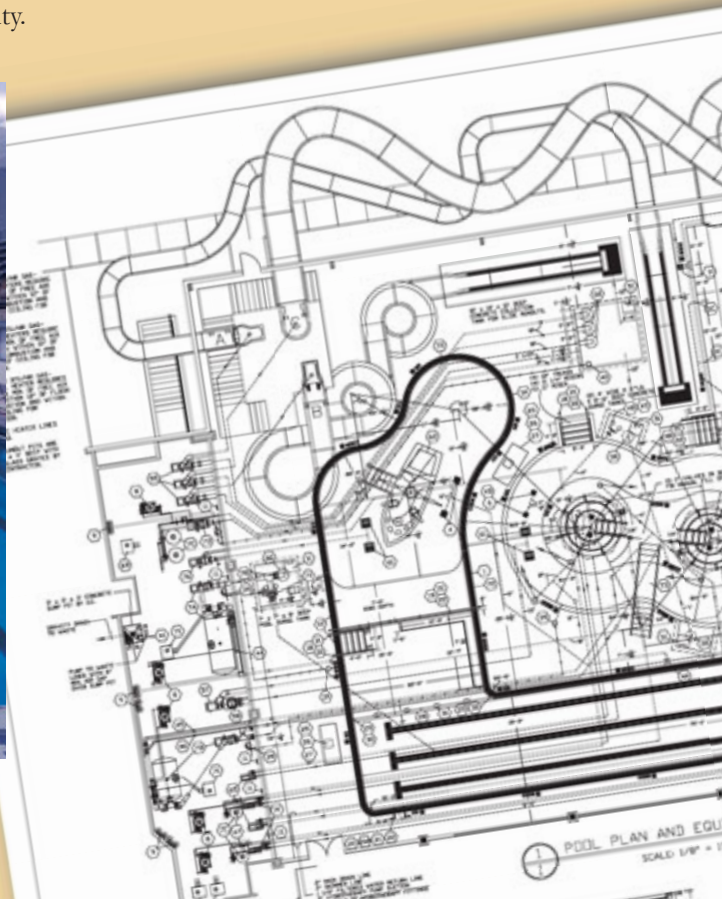

Equipment

Paddock is widely recognized as representing the industry standard for innovation and excellence. Our perimeter recirculation systems, vacuum and pressure sand filters, and bulkheads are custom-fabricated in our own 250,000 square foot manufacturing plant for every project we build. Paddock has a product for every performance level and budget—without sacrificing quality.

But Paddock isn't just a manufacturer. We specialize in offering complete pool equipment packages for every pool. That means we care about the little things as much as the major components, because they matter to you. In fact, we're the only major equipment manufacturer with a Customer Relations Program—we want to maintain a long-term relationship with every pool that has Paddock equipment—to insure satisfaction that exceeds expectations. You shouldn't have to call a distributor or a contractor or a service company if you need something. If you have a Paddock pool, just call us and we'll take care of you. It doesn't matter if you just need a part, if you want to repair or expand your facility, or if you simply need some service arranged. Our goal is to treat our distinctly Paddock pools like the family they are.

Construction

Paddock's Preferred Builder network is comprised of construction specialists who adhere to the strictest quality standards. We highly recommend them for new construction or major renovations. Paddock builders are located all across the country, with skilled crews representing decades of experience. Contact us to locate a builder near you for assistance with your specific project.

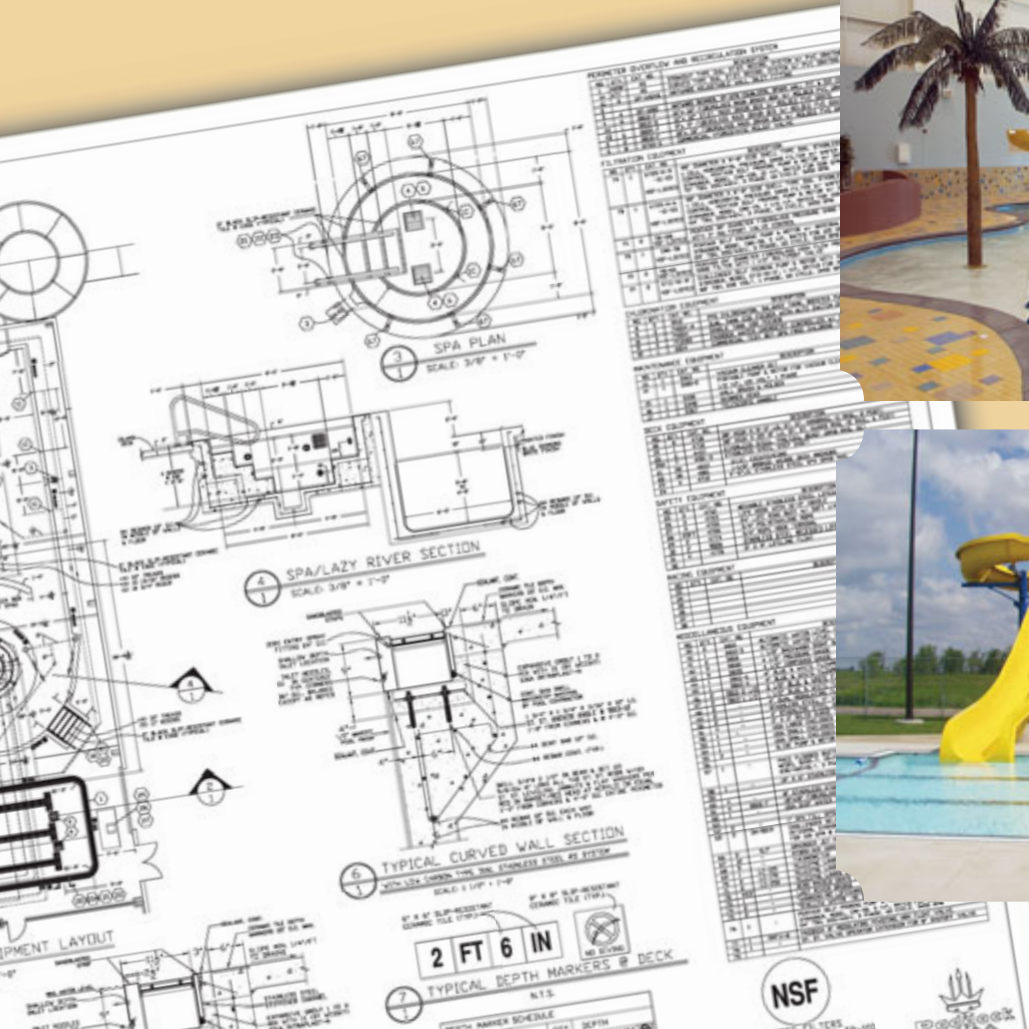

Planning, Bidding, Building: Partner with Paddock from Start...

A successful project is one that turns what was once just a dream for a preferred future into a present reality, fulfilling expectations exactly in its final result, without making compromises along the way. In short, a Project Mover should get exactly what he wants in the end. We prefer the term “Project Mover” to Owner, because behind every aquatic project there is someone

with a passion for competitive swimming, improved fitness, community building, instruction, family recreation, institutional growth...or any combination of these worthy endeavors. Paddock’s vision—and every aspect of our business—has been shaped by over 85 years of experience and is carried out each day with the desires and demands of the Project Mover in mind.

Paddock exists to create the nation’s most distinctive commercial aquatic facilities by providing quality equipment, specialized services, and customer support that exceeds expectations.

Planning



Take advantage of Paddock’s complimentary planning services:

- » Three-dimensional, full-color artistic renderings
- » Set of architectural plans in AutoCAD
- » Sectional views & product details
- » Vendor and product evaluations
- » Complete list of equipment
- » Design narrative
- » Construction & equipment specifications
- » Budget forecasting
- » Contractor qualification guidelines
- » Coordination of related trades

Vision

Our Vision springs from the word *create*, to bring something into existence that will enrich the lives of users for decades. To that end, Paddock places a major emphasis on careful, collaborative planning: bringing together as many individual experts as possible to achieve the desired result. Our approach is first to ascertain the goal of the Project Mover, then to listen to the planning team—design professionals, aquatic directors, facility managers, investors, coaches & therapists, etc.—to determine the scope and uses of the proposed pool. From there, we shape a preliminary proposal, present it for consideration and approval, and we’re off and running. This is what we mean by the nation’s most distinctive aquatic facilities—each one is special and unique. Everything that happens from this point is part of a controlled process, to ensure that what is now on paper will soon be transformed into bricks and mortar (actually, concrete, steel, and water!).

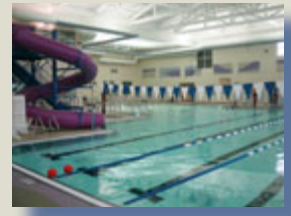
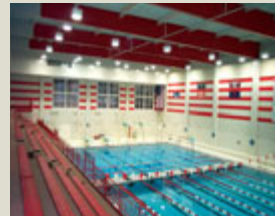

...to Finish.

www.paddockpool.com

Over forty years ago, New York pool contractor Bill Baker took over Paddock of California and changed the company's focus from the residential to the emerging commercial market. His efforts resulted in the widespread acceptance of many construction standards practiced today, such as the use of gunite and the stainless steel recirculating perimeter. The goal was simply to provide products and services that would allow specialized pool contractors to assume single responsibility for the project to ensure a quality result. While ownership has changed since that time, Paddock's commitment to construction expertise has not. Among major manufacturers in the pool industry, only Paddock has the first-hand knowledge necessary to make sure the pool drawn on the plans can be built properly, within the budget, and with nothing missed along the way. Because of our historic, continuing relationship with the best pool builders in the country, we are uniquely qualified to help you cover all the bases.

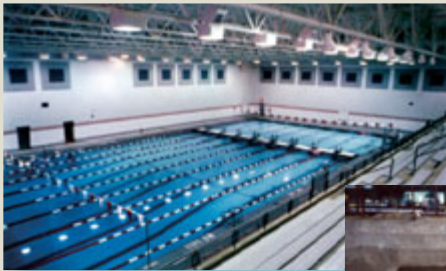

Building

Once the pool is built and most contractors and suppliers are long gone, Paddock seeks to initiate a long-term relationship with the new owners of our pools. A call from our Customer Relations department provides an opportunity to evaluate the pool design, to make sure everything is working, to provide additional accessories, or to coordinate service. We're not a distribution company per se, but we do stock parts and offer a catalog of standard supplies and quality products from other manufacturers for our pools. If you need something and we don't have, we'll get it. The more we have had to do with the design, equipment, and construction of your pool, the more we can help you maintain and improve your facility as the years pass.

We not only design and equip the nation's most distinctive aquatic facilities, we build them, too, through our Preferred Builder network. Can you get more expert than that?

Bidding

Before you build, consult Paddock to:

- » Choose the approach that is best for your project (public bid, negotiated, design-build, design-bid, allowance, etc.)
- » Establish base bid/alternate specifications to ensure competitive bidding by contractors
- » Set structural requirements for pool & equipment room
- » Consider options for lighting, buildings, bath-house or locker facilities, decks, HVAC, etc.
- » Coordinate plumbing and mechanical work
- » Coordinate electrical work
- » Outline project construction schedule phases

“We want you to be happy with your Paddock pool, not just when it opens, but always.”

Paddock Recirculating Perimeters

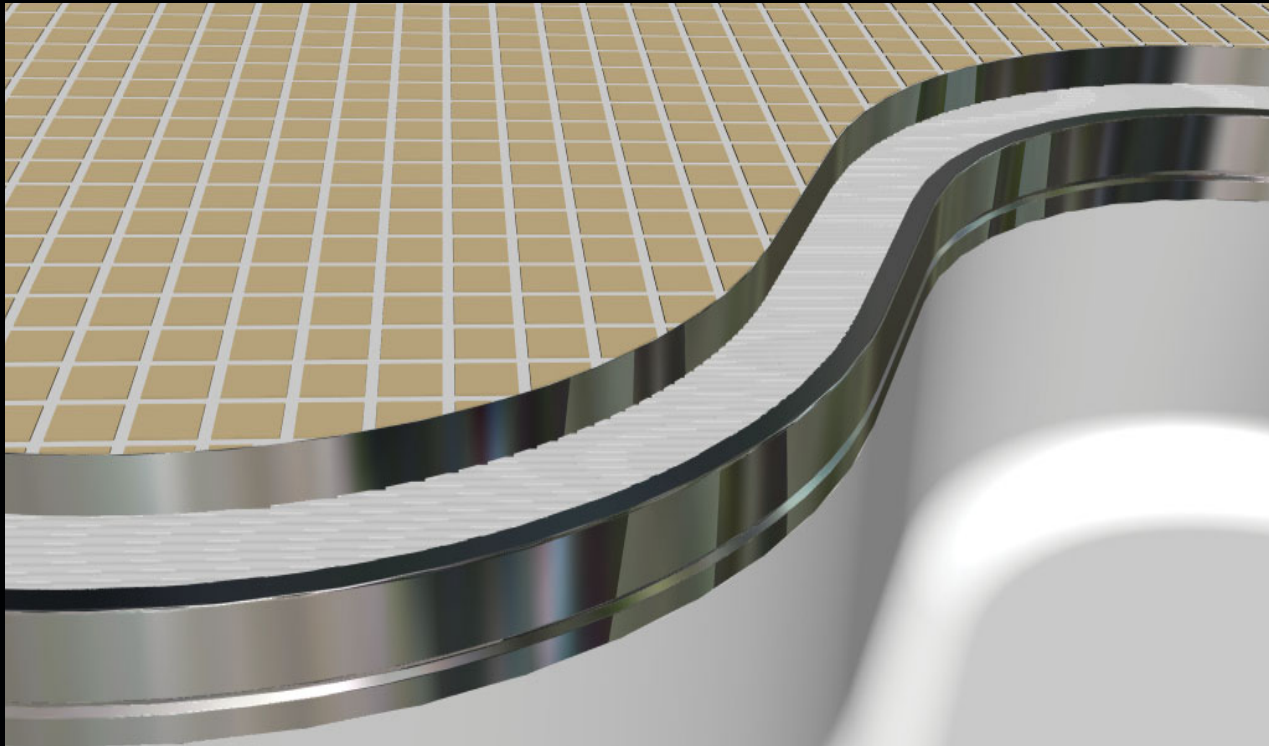

Patent Pending

Paddock perimeters represent nearly a half century of innovative design and precision manufacturing. Paddock was the first to promote the many benefits of a pre-fabricated, integral flow perimeter system for commercial pools—way back in the early 1960's. So it is no surprise that we continue to lead the industry in specialized products for every type of aquatic project, whether for world class competition or just plain fun. A stunning example is the **Radius Section (RS) perimeter—the only free-form integrated system available today.** Combining the practical benefits of an integral perimeter with enhanced aesthetics, the RS is just the newest advancement in the long history of breakthroughs in recirculation technology from Paddock.

Custom Renovations

Paddock perimeters are perfect to rehabilitate chronically troublesome older pools. Cutting the old gutter off the pool wall and installing a customized, pre-fabricated Paddock system provides a permanent fix for pools with cracked concrete gutter troughs or leaky recirculation plumbing. Simply provide us with blueprints or measurements of the existing wall dimensions and we'll submit a comprehensive solution, taking into consideration variables such as the desired flow rate, surge capacity, deck-to-water, and depth of your "like new" pool.

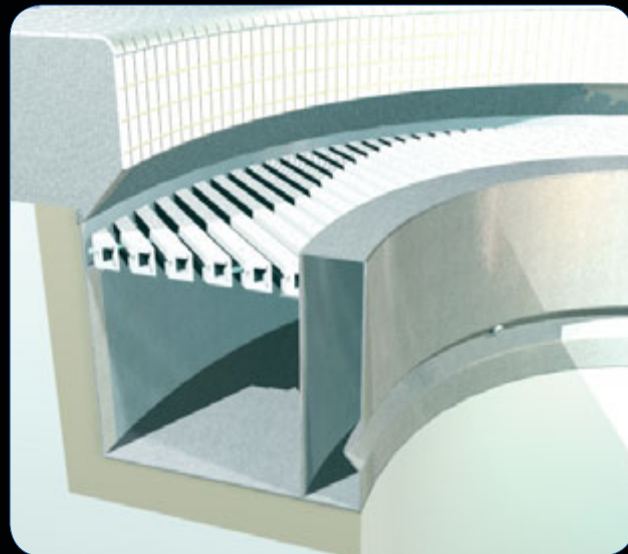

Paddock Recirculating Perimeters

All stainless steel perimeters consist of a main overflow channel, to receive water from the pool surface, and a filtered water return conduit, to recirculate clean, sanitized water back to the pool. The primary benefit of such a system is to eliminate the maze of buried piping required for concrete troughs and skimmers, thus also eliminating potential leaks and the costly repairs that accompany them. But a closer look reveals that not all stainless steel perimeters are the same.

Paddock perimeters are featured on virtually every type of pool, large and small, including fitness centers, swim clubs, and therapy pools. Until now, leisure pools have presented a unique challenge to the architect who understands the practical benefits of an integrated perimeter but desires a curving, free-form shape. The Paddock RS system provides both. For the first time, **function follows form**. The RS can be custom-fitted to virtually any contoured wall, limited only by the designer's imagination.

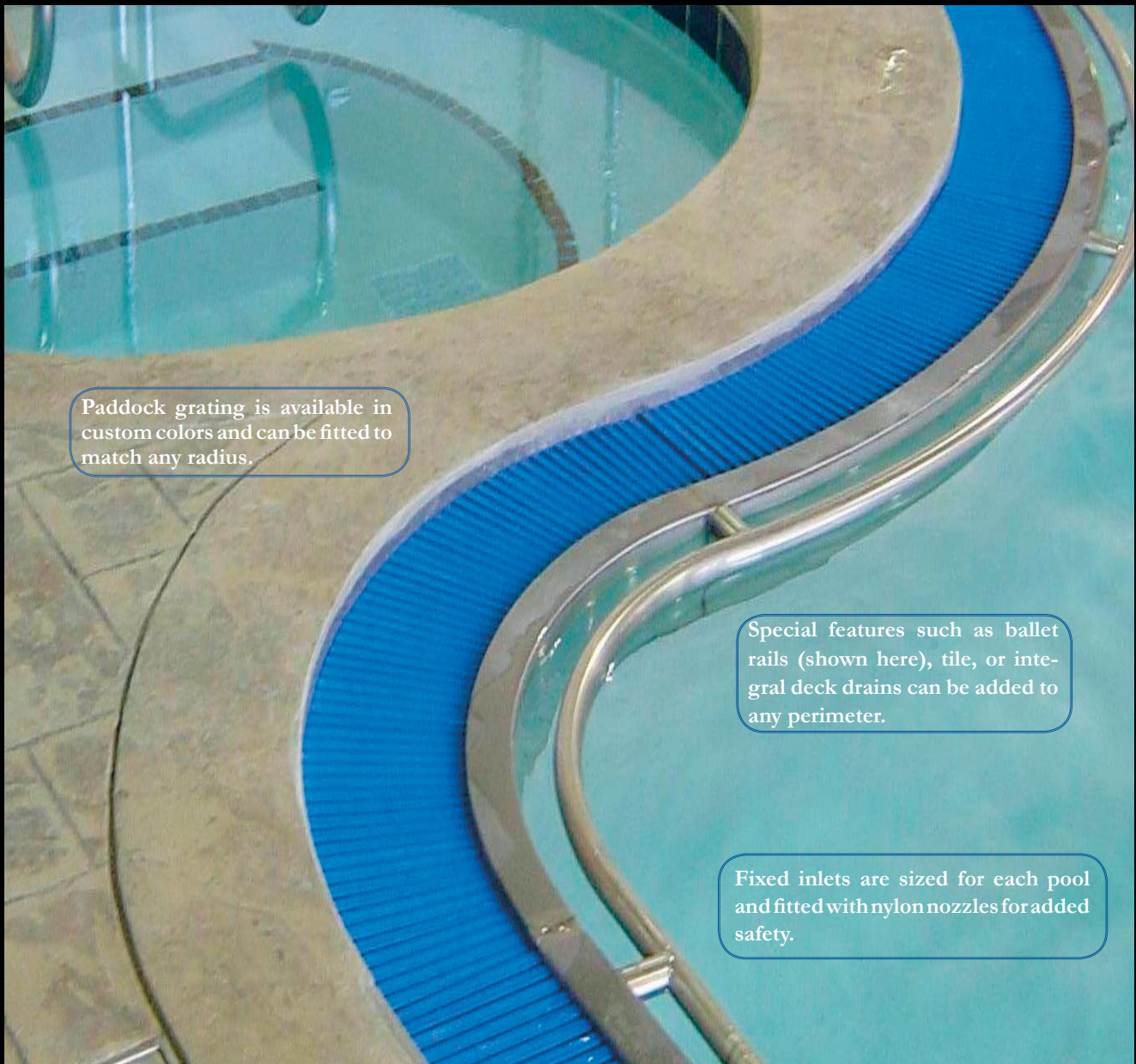

Paddock grating is available in custom colors and can be fitted to match any radius.

Special features such as ballet rails (shown here), tile, or integral deck drains can be added to any perimeter.

Fixed inlets are sized for each pool and fitted with nylon nozzles for added safety.

Paddock Recirculating Perimeters

Performance separates Paddock from the rest. Only Paddock has successfully developed factory-fabricated multi-channel perimeters that not only carry water, but control dynamic surge as well—thus creating the smoothest surface possible: the optimal condition for speed. An example is the [Paddock SCRS perimeter fitted with Auxiliary Surge Recovery \(ASR\)](#), a three-channel system designed exclusively for use at championship facilities, such as Centennial Sportsplex in Nashville, and the University of Michigan in Ann Arbor.

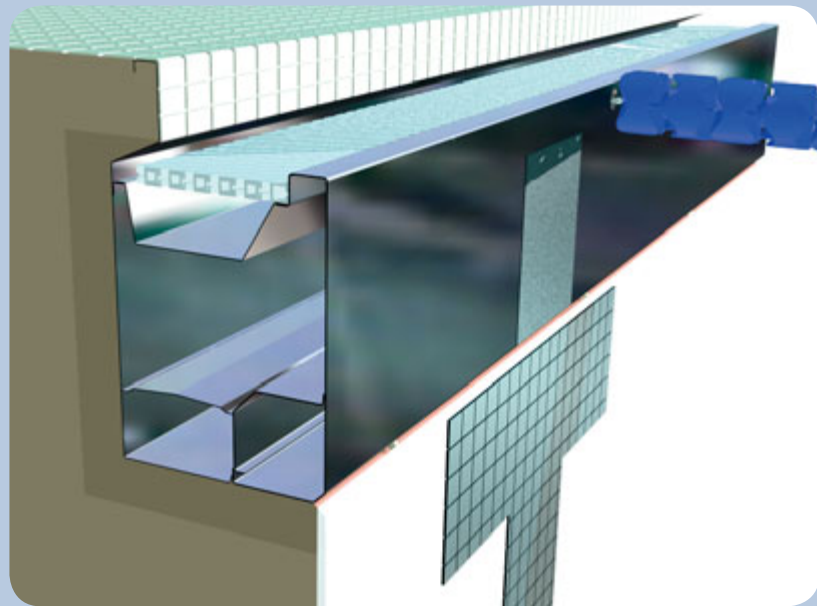

The SCRS-ASR captures waves entering the overflow channel and continuously transfers surge to a covered lower channel below, where it flows uninterrupted to the filter and back to the pool. Should the lower channel reach a pre-set level, an auxiliary pump draws the water through the ASR chamber to prevent the gutter from flooding under any conditions. The result is **an aquatic environment designed for speed** that cannot be duplicated by any other recirculation method.

Standard Features

All Paddock perimeters are [factory fabricated](#) for simplified installation and precision fit-up. Paddock's state-of-the-art computer-driven machines insure that every perimeter is sheared, formed, and welded to exact dimensions and **shipped to the site in complete sections with minimum field welding required**. Fabrication and testing under controlled conditions in the Paddock plant result in the highest quality installation performed by **Paddock certified technicians**.

Inlets are punched in the plant—not drilled in the field—and fitted with [nylon jet nozzles sized for the flow rate of each pool](#) and fixed at a 45 degree angle downward. The nozzles are recessed in a stylish V-Groove to protect the plaster finish below. Inlets are spaced 36 inches on center around the perimeter and grouped under racing line anchors at the end walls. This insures that swimmers approaching the wall are not impeded, or, if touch pads are installed, recirculation is not inhibited.

Paddock's [protective grating](#) is made from slip-resistant PVC reinforced ribs running perpendicular to the pool. It's **32% open area** permits maximum flow into the overflow channel, but minimum spacing between the ribs prevent entrapment. Paddock's grating is easily adaptable to radius curves and corners.

Paddock recommends [Type 316L stainless steel](#) material to all specifying architects for maximum corrosion resistance.

Little things can make a big difference. That's why all Paddock perimeters feature [jet wash fittings](#) to flush the overflow channel with filtered water to keep it clean and to prevent algae growth, a slip-resistant finish on all exposed surfaces, and recessed anchors.

Paddock Recirculating Perimeters

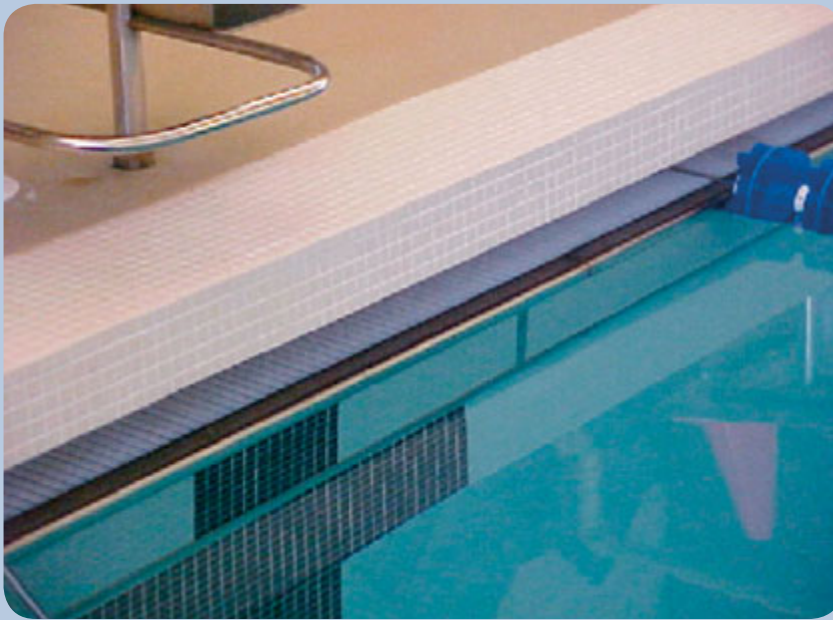

Paddock doesn't apply performance engineering only to elite competition venues. The same technology is employed in the versatile **IFRS-ASR** perimeter, a two-channel system designed for any pool used for competition as well as recreation, where "point" flooding is a constant problem. The ASR feature is engaged only when needed to ensure **maximum surge control and efficiency at all times**. No other perimeter provides as much capacity.

Options

Paddock perimeters are available in **custom configurations** and varying dimensions, from deck-level roll-out to fully-recessed designs.

A removable **tile face** provides a non-skid surface for flip turns and unmatched aesthetics.

In-Pool Surge Capacity is accomplished by Paddock's automatic **surge control weirs**, which are responsive to the changing water level in the pool.

Paddock's **grating can be matched to any desired color**.

Integral deck drains can be added to any perimeter.

Paddock's **Zero-Depth perimeter** is a complete recirculation system with both an overflow channel to receive waves lapping up at a beach area entry point, and an inverted filtered water supply tube that sprays clean, sanitized water back across the surface through fixed inlet nozzles. The result is unbroken recirculation around the entire perimeter—especially where it is needed most—with **an added play feature children of all ages can enjoy**.

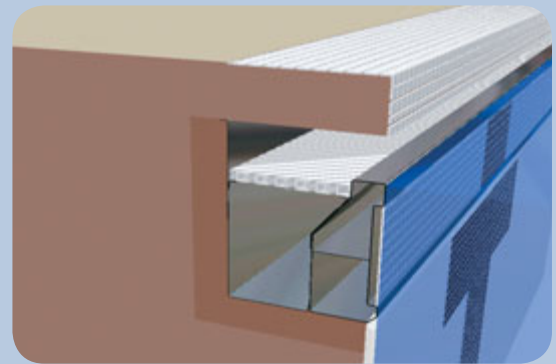

The photo (top) shows a fully-recessed IFRS-ASR perimeter system with tile. The interior of the stainless steel perimeter section is represented in the cut-away detail (above).

1. The main overflow channel receives waves from the pool and conducts water to the filter system.
2. The separate return tube delivers filtered water back to the pool.
3. The Auxiliary Surge Recovery (ASR) chamber receives water only when needed; as the overflow channel fills, a sensor reads and activates a separate pump that draws down water into this chamber and returns it to the pool. In this way the overflow channel never floods—insuring smooth, fast water.

The Compak Vacuum Sand Filter

Paddock revolutionized the commercial pool industry with the introduction of the first vacuum sand filter in 1978. Today's Compak model is the most distinctive filter available, representing the state-of-the-art in every way:

DESIGN: The open top, square filter is fed by gravity and houses the pump(s), media, valves and piping inside the stainless steel tank installed below grade for **maximum efficiency of space**.

PERFORMANCE: Vacuum sand filtration has been proven to produce **dramatically clearer water** than pressure systems; in fact, the Compak delivers the same polished water as Diatomaceous Earth filters—without the extra cost, high maintenance, and environmental concerns associated with DE (see Theory, at right).

COMPONENTS: Paddock uses only the **highest quality components** in the Compak, such as non-corrosive valves, stainless steel cylinders, molded ABS laterals, fiberglass equalization screens, and rigid, non-skid protective grating.

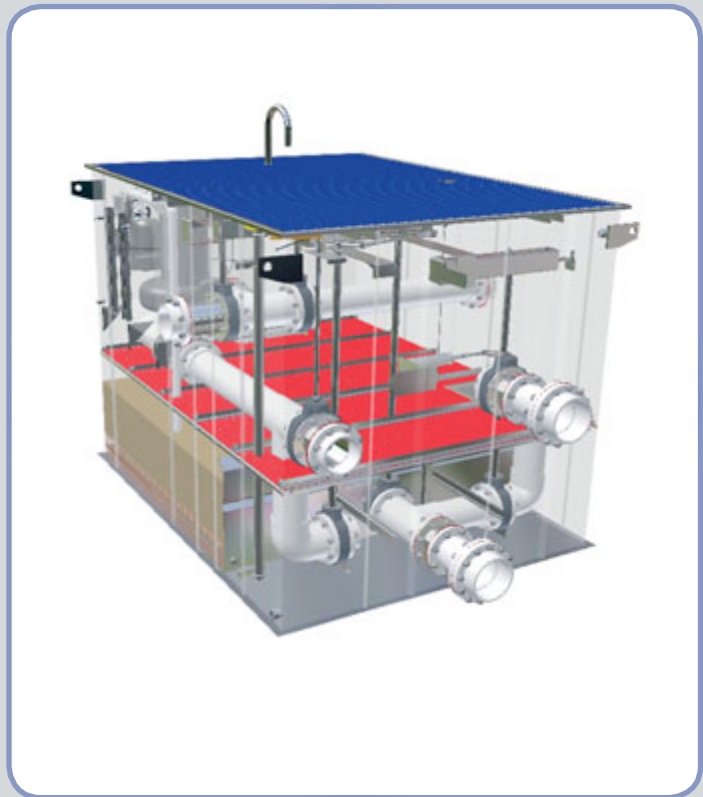

The most economical filtration system on the market

For all the Compak's inherent superiority over pressure filters, this might seem an odd question. But a closer look reveals that **no other system saves the owner as much in terms of money, time, and other valuable resources**.

The Compak's efficient use of space is its first and most obvious benefit. With the Compak, an architect doesn't need to worry about how to get large pressure tanks and piping into (and out of) the equipment room, because **the filter is entirely below grade**. In fact, the walls of the equipment room can be drawn in around the Compak to the smallest possible footprint, **saving significant construction costs**. The resulting room is smaller but seems much larger—wide open, in fact. From headroom to square footage, the Compak saves the most space. And, because both the main drain and perimeter overflow lines converge in the Compak, it also acts as a balance tank, saving even more space and money.

Paddock's Touch Master Control Panel offers **backwash options on a timed basis or on demand with the push of a button**.

The natural phenomenon of vacuum filtration results in much **longer filter runs** than with pressure filters. It is not uncommon for a Compak to require a three to four minute **backwash only once every month** under normal conditions. This amounts to a **dramatic savings in water and chemicals** over time. And the Compak can be equipped with **air scour**, which reduces the backwash rate by two-thirds, when site conditions warrant.

The Compak is built for long-term, heavy-duty use. A stainless steel tank anchored and enclosed in the concrete floor, the Compak will last the life of the pool. But if normal maintenance is ever needed—to replace the media or work on a valve, for instance—it is as easy as removing the grate.



Theory of Vacuum Sand Filtration

Most filters function by mechanically straining solid impurities from the water. Water from the pool is forced into a pressure vessel, where filtration takes place at the top of the media bed by simple entrapment of particles. This results in shorter filter runs and frequent backwashes as the upper portion of the bed becomes clogged.

By contrast, with vacuum sand filtration, **water is drawn through the media**, where electrostatic attraction between sand grains and the contaminant particles occurs. This process, called depth filtration, utilizes the entire media bed and results in the **removal of extremely small particles**, down to 1.0 microns in size.

Under the vacuum, even smaller colloidal particles group together to form larger particles which can be removed, resulting in the **clearest, cleanest water possible**.

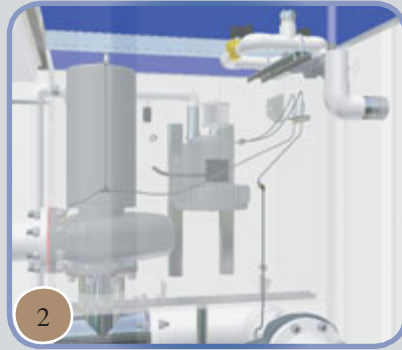
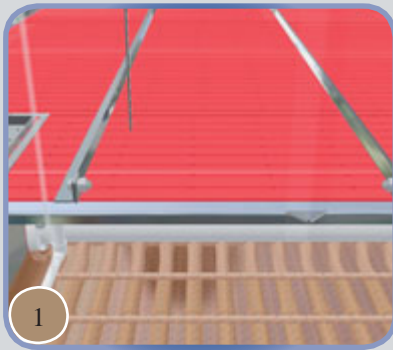

1. The **equalization screen** is perforated to allow equal distribution of influent water across the entire surface of the media bed.

2. The **main recirculating pump** is mounted inside the walls of the filter tank. Though completely beneath the grate and out of sight on newer models, it is easily accessible.

3. All internal components, such as the **valve** shown here, are **heavy-duty and non-corrosive**.

4. The main drain and perimeter overflow lines enter the Compak together, allowing the filter to serve as its own **balance tank**.

5. An **air scour distribution network** supplements conventional backwash system for dramatic water and chemical savings.

6. **Additional surge capacity** is available in every Compak.

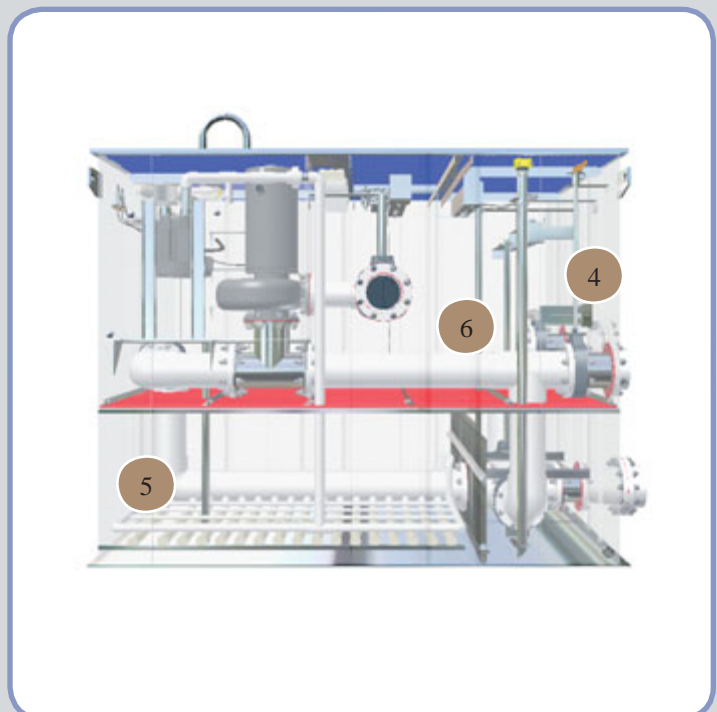

Dual Cell Vertical Pressure Sand Filtration



When a Paddock Compak vacuum sand filter is impractical (such as with a below-grade equipment room, a filter replacement in a restricted space, or for a small pool), choose one of Paddock's pressure sand filters for sparkling clear water.

Paddock's Type 316L Stainless Steel Vertical filter saves both floor space and water. Its two or three vertically oriented cells are backwashed individually and sequentially with filtered water, reducing the flow of water to waste, and allowing the reduction of piping and elimination of holding tanks. Underdrain ABS laterals are covered with stainless steel mesh and fitted to a sand bed of 18" minimum depth. Dual cell filters range from 36" diameter (212 gpm) to 120" diameter (2,356 gpm). All models are NSF listed. The Vertical is also available in carbon steel with epoxy interior and exterior linings. ASME Code and Labeled filters are available and recommended.

Standard on every Paddock Vertical is a dividing head (in lieu of a flat plate) to separate the cells, providing added strength and protection against deflection, which can damage the internal distribution system.

Dual Cell Horizontal Pressure Sand Filtration

There's no sense in wasting water, crowding limited space, or throwing money away—that's the rationale behind Paddock's line of dual cell horizontal pressure sand filters. Why fill a filter room with two tanks when one will do? Just because the site dictates a limited backwash capacity doesn't mean the filter room must be crammed full of individually backwashed filters to accommodate the restriction. The dual cell horizontal features two filtration cells in a single tank; backwash one at a time and you have solved your restriction problem without having to install new plumbing, or expand or modify the existing equipment room to handle multiple tanks. Stack them and you reduce your backwash rate even more. All filters are made from Type 316L Stainless Steel, are NSF listed, can be operated by manual or automatic control, and feature all the standard high quality Paddock components.

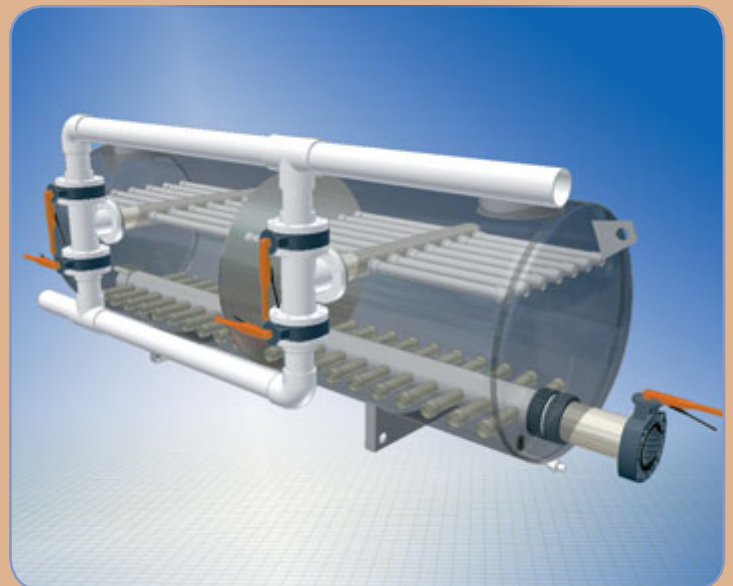

Single Cell Pressure Sand Filtration



Type 316L Stainless Steel Filters

Built for Strength

- Molded ABS Header/Lateral internal distribution system
- Marine Grade Stainless Steel for maximum protection in corrosive environments
- ASME (Optional)
- Epoxy Exterior Coating
- 50 PSI rating
- NSF Listed

Horizontal Pressure Filters are an economically sound investment for smaller commercial pools, and are perfect for renovations. Paddock offers two choices: Type 316L Stainless Steel (pictured above & below) or Fiberglass tanks. Both offer the benefits of all horizontal filters—low price, easy to install, and simple operation. Both can be stacked or installed side by side, and both can be manually or automatically operated. But each has its own distinct advantages as well. There are more sizing options with stainless steel tanks, with models ranging from 36” diameter and 4’ side shell length to 96” diameter and 12’ side shell length—a total of 99 sizes to choose from! This makes it easy to select a single filter for your pool, which means more efficient filtration and fewer backwashes. And, Type 316L Stainless Steel tanks can be built to ASME Code and Labeled. The independent third-party inspections during the fabrication process insures the owner of getting a product certified by strict ASME standards. Fiberglass pressure vessels cost less and weigh less, and are thus better for renovations of existing pools, where there are tight budgets and tight spaces. Paddock’s horizontal filters represent the highest quality and greatest flexibility available.

Fiberglass Filters:

- Gel coat interior barrier for protection against corrosion and abrasion from sand
- Additional layers of fiberglass and isothalic polyester resin, with woven fiberglass reinforcement and radial filament winding
- Injection-molded, non-clogging diffuser heads
- Type 304 Stainless Steel hardware in wetted areas
- 16” round manway
- NSF Listed



Two Pools in One

A movable dividing bulkhead is the simplest and most cost-effective way to maximize the efficient use of any aquatic facility. It allows for ultimate flexibility in programming by creating separate areas for competition, instruction, or recreation in the same pool to be conducted concurrently, if desired. So, the swim coach can hold practice while the fitness instructor is teaching water aerobics class, or while the aquatics director is conducting a lifesaving course, or while kids are playing. Because the bulkhead is movable, the competition courses can be easily changed from 25 yards to 25 meters or 50 meters. Deep and shallow areas can be segregated, minimized, or expanded depending on the scheduled activity. For large pools, two or more bulkheads can create even more options. And, by adding a bulkhead to the design, an owner essentially gets two or more pools for the price of one. Capital and operational costs can be dramatically reduced by using a bulkhead in one pool instead of building two separate pools for various uses.

The Proven Leader

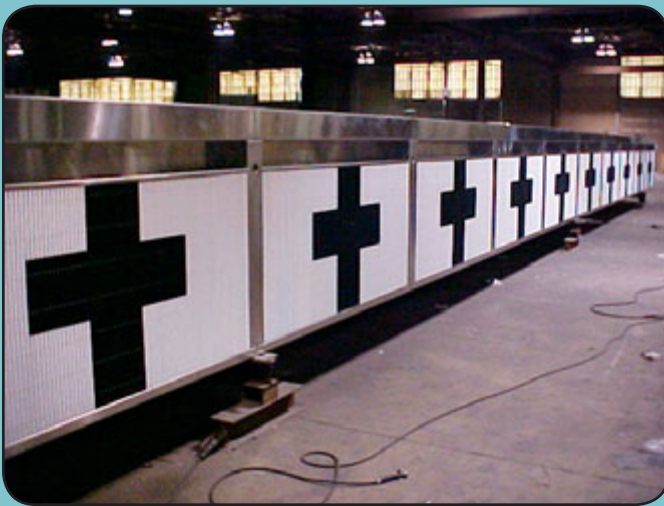

Paddock bulkheads are custom-built entirely from stainless steel and are engineered for strength and durability, ease of use, and low maintenance. Our first bulkheads were built in 1971, and with over three decades of experience with installations at such notable venues as Arizona State, LSU, Notre Dame, the University of Michigan, and the University of Houston, Paddock remains the leader in the industry.

Most of our bulkheads are four feet wide, but five and six foot wide bulkheads are becoming more popular. Paddock can fabricate a bulkhead to exacting specifications, with any width and depth desired by the customer. When used on pools with our stainless steel recirculating perimeters, Paddock bulkheads are fitted with wheels for easy movement; our skid-mounted bulkheads can be installed on any new or existing pool wall. Starting platforms, timing equipment, and stanchion posts are commonly included. Today's Paddock bulkheads are made with Type 316L stainless steel to resist staining in corrosive environments.

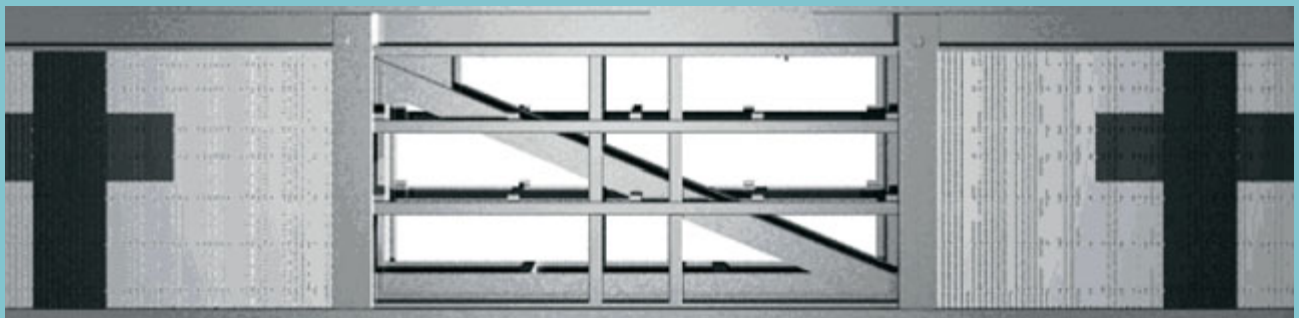

Flow-Through Design

A singular advantage of stainless steel bulkhead construction is its flow-through characteristics. While the bulkhead takes the appearance of a solid, floating bridge in the pool, there is actually an open area of 32% in the target panels installed in each lane. Sanitized water is constantly entering and flowing inside the structure on both sides. The benefits of this design include:

Ease of movement. The Paddock bulkhead displaces less water and is therefore less restrictive during movement.

Improved Sanitation. There are no closed, dark spaces within the bulkhead interior where algae can grow.

Speed. Because water is passing through the target as the swimmer approaches, the rebound of waves is minimized during flip turns, improving times.

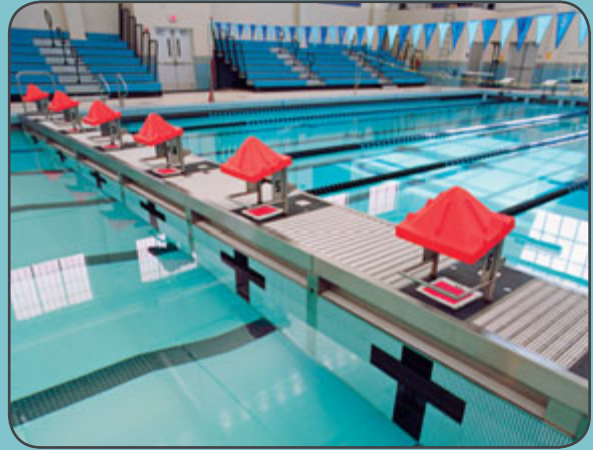

Safe Surfaces

While its steel framework gives the Paddock bulkhead strength and durability, only about 30% of the visible surface of the Paddock bulkhead is stainless steel. The remainder is comprised primarily of reinforced, slip-resistant PVC grating to maximize safety, enhance aesthetics, and create versatility. The grating is the same type used in Paddock recirculating perimeters. Design features incorporating grating include:

Targets and Tops. Contact surfaces are formed with knurled, slip-resistant PVC grating that is excellent for flip turns, and for walking or standing on the “deck” of the bulkhead.

Recessed Handholds. Positioned at the waterline in each lane, the convenient handholds also feature protective grating to prevent access to the interior of the bulkhead and possible injury to a swimmer who might get a hand or foot caught inside.

Target Spacing. The gaps between the PVC ribs in the Paddock bulkhead target grating are 9/32” —large enough to allow water to flow through, but small enough to prevent entrapment of toes or fingers.

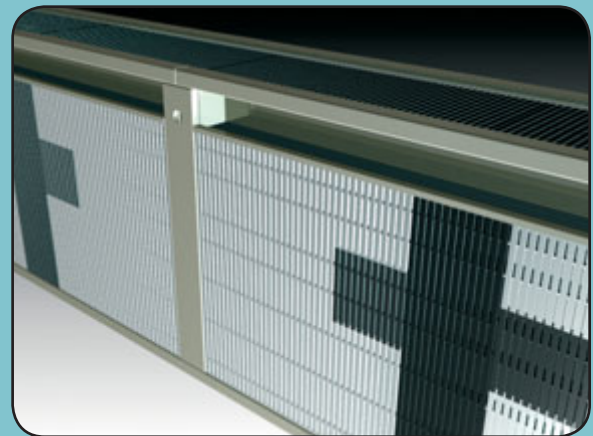

Unsinkable

Moving a bulkhead is often made easier by injecting air inside to lighten its load in water. But, improper design can result in disaster if water accidentally rushes into the interior compartment, sending the bulkhead to the bottom—and it can happen very quickly. Not only has Paddock never had a bulkhead sink, the fact is that a Paddock bulkhead simply can't sink, because it is designed with both fixed and variable buoyancy. Inside every Paddock bulkhead are balanced chambers filled with tightly wrapped foam running the length of the structure to insure permanent floatation. To assist with movement, an equally balanced interior chamber can be filled with air. Thus the Paddock bulkhead is always structurally stable—and unsinkable.



*Paddock
exists to create the nation's most distinctive commercial aquatic facilities
by providing quality equipment, specialized services, and customer support that
exceeds expectations*



*P.O. Box 11676 • 555 Paddock Parkway
Rock Hill, South Carolina 29730
Ph: 803-324-1111 • Fx: 803-324-1116
Ph: 800-849-2729
www.paddockpool.com*