

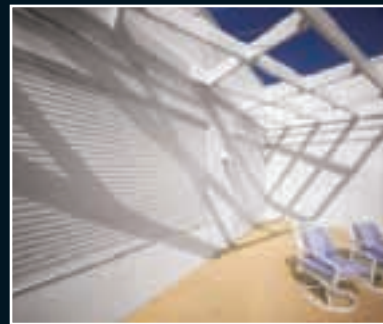



Store**Safe**®

- Commercial Buildings ■ Kiosks ■ Retail ■
- Medical Centers ■ Clinics ■ Schools ■



Storm**Safe**®

- Homes ■ Balconies ■ Businesses ■
- Governmental Properties ■
- Coastal Properties ■



Product**Safe**®

- Cigarettes ■ Cell Phones ■ DVDs ■
- Medical Records ■ Electronics ■
- Type Two Pharmaceuticals ■



Home**Safe**®

- Windows ■ Patio Doors ■
- Home Theatres ■ Porches ■



Counter**Safe**®

- Pharmacies ■ Fast Food ■
- Counters ■ Press Boxes ■
- Stadiums ■ Concession Stands ■



Store**Safe**®

Vision Slat – AL6 Punch 51

- Perfect for Storefronts and Malls
- High Visibility ■ Lightweight ■
 - High-Security ■ Strong ■
 - Easy to Operate ■ Beautiful ■
 - Unnoticeable when Up or Down ■
 - Can act as a Sun Screen ■

AL6 Punch 51

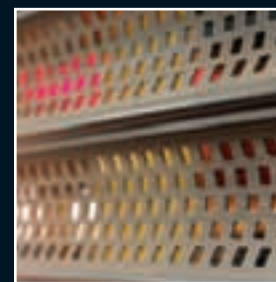

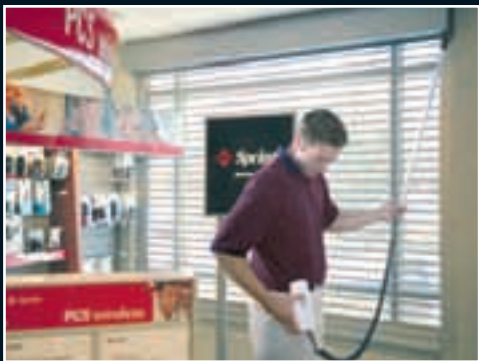

Introducing the **Power Pole**
See page 21 for details



Our new **Push-Up/Pull-Down**
See page 21 for details

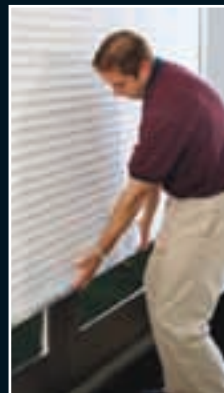



Punch 11

Security with Vision

StoreSafe Shutters and Grilles are designed to give the utmost in security and unmatched aesthetics. In short they offer Security with Vision.

Select either StoreSafe Accordion or Roll Down Shutters and Grilles to best suit your application. Our shutters are manufactured to withstand abuse and daily use. Many different styles and colors are available to best compliment your installation.

StoreSafe Rolling Shutters and Grilles

Self Supporting—Reduce Construction Costs

Reduce Construction Costs...no structural tubes or expensive construction required to support the shutter coil. QMIs self support the coil, so they can be mounted directly on the storefront or framed wall.

Coil Housings

Neat, clean, StoreSafe Rolling Shutters and Grilles are the answer to the ugly overhead steel doors of yesterday. Our rolling shutters roll up into a small coil housing. Our coil housings are available in square, round and 45 degree shapes to best accent your installation and available in a large selection of standard colors. Custom colors are available. See page 20 for available shapes.

Solid Profiles

StoreSafe solid profiles secure your business and property from intruders and prying eyes. Many customers require no visibility when the store and their property is unattended, taking away the temptation from would-be burglars. See page 19.

Vision Profiles

StoreSafe vision profiles provide security with the ability to see through them. Many vision profiles are available, Transparoll Clear Solid Polycarbonate profiles, solid punched slats with a variety of punch patterns, or assembled link grilles with a selection of patterns. See page 19.

Operation

Select motorized or manual operations. Our shutters can be locked or operated with a key switch. See our operation options on page 21.

Visit us at: www.qmiusa.com/storesafe



Guarantee
It's a QMI

See pg 9



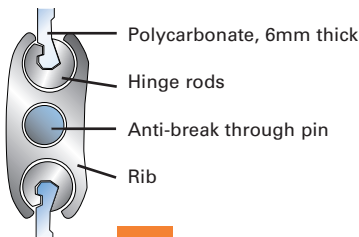
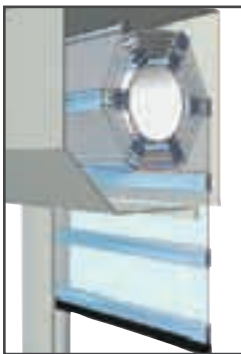

■ Transparoll has a unique structure, the ribs hold the polycarbonate in place and keep it from rubbing against itself. This keeps the polycarbonate (transparent) material looking like new.

Transparoll / Transparent Polycarbonate

QMI introduces Transparoll transparent rolling shutters. When you need security and you never stop selling—Transparoll is your choice.

The Benefits are Clear

- Visibility up to 85%
- Made of impact-resistant polycarbonate 6mm thick
- 250 times stronger than glass of the same thickness
- UV-Resistant, preventing discoloration and ensuring its clarity

Transparoll® Transparent Polycarbonate

When you need security while maintaining the ability to keep selling—Transparoll is the perfect application. Transparoll provides visibility up to 85% through the use of impact-resistant 6mm thick polycarbonate which is 250 times stronger than glass of the same thickness. Transparoll rolling shutters are—UV-resistant, preventing discoloration and ensuring its clarity.

Visit us at: www.qmiusa.com/storesafe/transparoll

StoreSafe Punched Slat



Above Style 51
Below left to right
Style 51 and 11

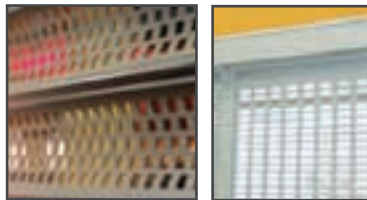

Punched Slat

- Visibility ■ Ventilation ■ Security ■

StoreSafe Punched Slat shutters are designed to give solid security with visibility. QMI offers many of its extruded profiles punched with a variety of patterns. The different profiles provide a variety of different levels of security and strength.

Selected profiles have polycarbonate inserts to provide a solid barrier with even more visibility. Many of the punched slats are powder coated for added durability of their paint finishes.

Our AL5 and AL6 punched slats are economical and perfect for installation inside the glass for storefront protection. It is also perfect for counters, malls etc. where minimal security and visibility are required. Many patterns are available.

Custom punches with your logo or specific pattern are available to make a unique impression.

Available Punched Patterns

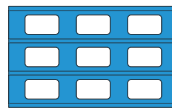

Style 11

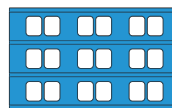

Style 21

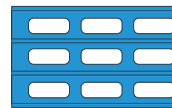

Style 31

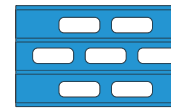

Style 41

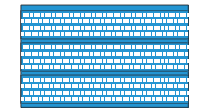

Style 51

StoreSafe Accordion



StoreSafe Accordion Shutters and Grilles

Our accordion shutters are available in solid panel, see-thru polycarbonate, and standard open grille patterns. Our accordion style shutters and grilles neatly stack in a closet and are perfect for those applications where very long spans are required, or there is limited headroom.

Many colors and anodized finishes are available, with easy to operate locking mechanisms that provide the ability for you to select your preferred lock manufacturer.

Grilles

StoreSafe Grilles are designed to give both security and visibility. StoreSafe grilles are manufactured with links when a traditional grille appearance is needed.

Two patterns are available and the links are available in two anodized colors.

Visit us at www.qmiusa.com/storesafe/grilles

StoreSafe Grilles

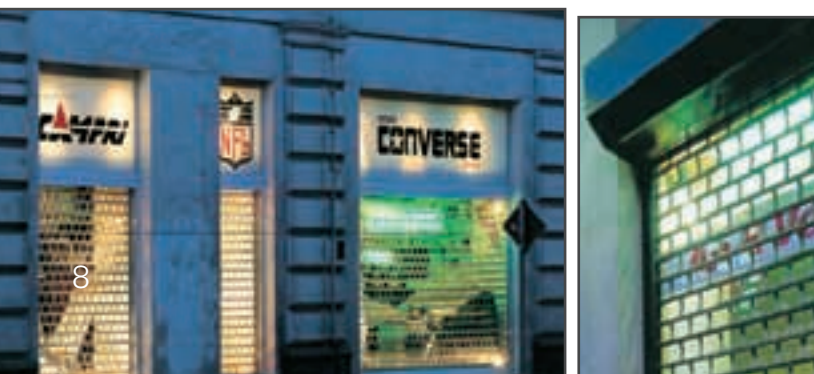

- Cigarettes ■ Jewelry ■ Sun Glasses ■ Cameras ■

ProductSafe Product Cases

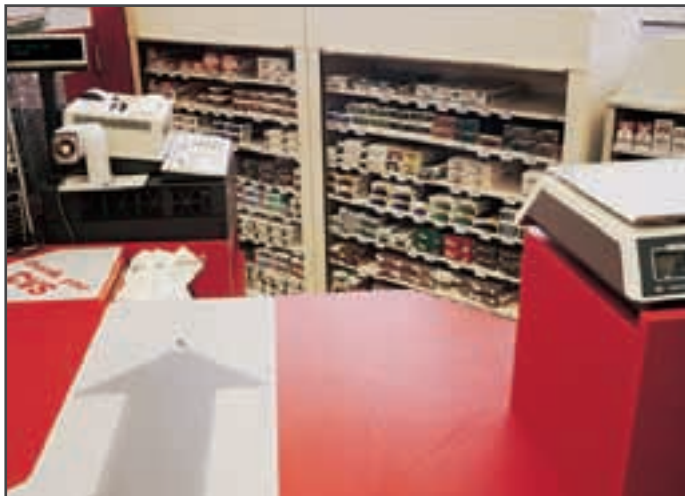

Keep valuable products safe in our patented ProductSafe® Security Roll Down Cases. ProductSafe cases are designed for protecting valuable commodities such as:

- Cigarettes ■ Video Equipment ■
- Jewelry ■ Pharmaceuticals ■ Cell Phones ■
- Expensive Electronics ■ Medical Records ■
- Notebook Computers ■ DVDs ■

ProductSafe cases are easy to use and effortlessly roll down and lock in place. And while they are not in use, the security curtain is completely out of sight.

ProductSafe cases are available in different sizes, shapes and colors, and can be custom designed to meet any specifications.

Visit us at www.qmiusa.com/productcases



Guarantee It's a QMI

Unfortunately there have been reports that customers believed they were purchasing a QMI quality shutter later to find out that a cheaper product was substituted.



Every QMI has a QMI product sticker with a serial number that identifies it as a quality QMI shutter. This serial number enables you to certify you have received what you have paid for.

Register your shutters for information regarding:

- Product ■ Service ■ Installation ■
- Maintenance ■ Warranty ■
- Technical Support ■
- Special Notices and Promotions ■

We keep full records and replacements for all products we manufacture to insure you can get approved replacement parts long after the sale.

Registering is easy –
Log on to www.qmiusa.com/myqmi

Enter your serial numbers

Ripped Off?

If you believed you have received another product instead of a certified original QMI, please let us know so we can help.

Log on to: www.qmiusa.com/rippedoff

Demand QMI!



■ Kiosks ■ Pharmacies ■ Fast Food ■ Counters ■





Counter Shutters

CounterSafe Rolling Shutters are perfect for counter applications where a quick and easily operated security barrier is required. They can be designed to be installed on the interior of the application to give a sleek look when closed. The base slat can be securely locked with a slide bolt or a keylock for maximum protection.

CounterSafe Rolling Shutters are perfect for pharmacies where state regulations are requiring more security. They are also perfect for kiosks and pass-through applications.

Visit our web site for more CounterSafe applications.

Visit us at: www.qmiusa.com/countersafe

Guarantee

It's a QMI

See pg 9



AL6 shown above Howard Holtzman and Associates Architects

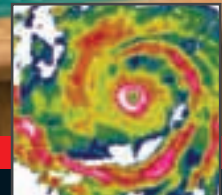

- After 4 years in Development
- 10,000 Hours of Design Engineering
- 10,000 hours in product testing
- 25 design revisions
- over 250 separate hurricane approval tests
- over 135 large missile impact tests
- testing pressures greater than 200 mph
- QMI presents—AL6 Hurricane Shutter



QMI Hurricane Shutters

Affordable-Strong-Easy to Use

Now you can give your home the protection and beauty of rolling hurricane shutters at an affordable price with QMIs. The QMI family of rolling shutters is backed by years of research and development and the best design engineering in the industry.

No other rolling hurricane shutters can match QMI's unique range of features and benefits.

Demand QMIs ...

For Protection and Security

- DADE County ■ Florida Building Code (FBC)
- International Building Code (IBC)
- International Residential Building Code (IRC)
- Texas Department of Insurance(TDI)

QMIs are tested to withstand hurricane winds of up to 200 mph or more. In addition to storm protection, they are designed to be used every day to provide privacy, protection against temperature, noise and sun fade; and security against break-ins – especially important when a disaster such as a hurricane strikes.

- QMI rolling hurricane shutters meet stringent state, federal and international building codes.
- QMIs offer a choice of strength and protection levels that are right for your area.
- A patented design locks each slat into side rails to prevent breakaways and shutter projectiles.
- Not just for hurricanes, QMIs can be used daily to provide privacy for you and your family, protect against outside temperatures and noise and guard against sun fade.
- Better than an alarm system, QMIs prevent break-ins rather than simply notifying you when your home has been invaded.

QMIs are Different than
Any Other Rolling Shutter!
See the Difference!

Visit us at: www.qmiusa.com/seethedifference

Guarantee

It's a QMI

See pg 9





“QMI has the only product that enables us to provide our customers the protection they need and the design elements we desire.”

Howard Holtzman
Howard Holtzman and Associates Architects

QMIs ... Beautifying Your Interior Design

QMIs are the perfect solution, maintaining beauty and style. They eliminate the need for clumsy, expensive and ineffective window treatments. When they are open, QMI showcase the beauty of your woodwork and the outdoors. When they are closed, they give you complete privacy, they reduce the effects of heat and cold, and most importantly, they keep you and your family safe. Nothing gives the ultimate in protection and aesthetics like QMIs.

Demand QMIs ...

For Beauty and Style

QMI rolling shutters are the best looking option available in hurricane protection. Unlike storm panels and accordion shutters that make your home look boarded up, QMIs are an attractive, decorative accent that will enhance your home every day of the year.

- QMIs come in a variety of styles.
- Choose from among many colors for the look that's right for your home.
- Shutters roll into a small space, making QMIs virtually invisible when they are not in use.
- Consider our coil housing options to add an architectural accent to your windows and doors.
- QMIs can cover window and door spans up to 20feet wide without unsightly, costly storm bars.

See page 18 for more information on our hurricane products.

Visit us at: www.qmiusa.com/seethedifference



See our new EZDrive system p21

Guarantee

It's a QMI

See pg 9



Guarantee
It's a QMI
See pg 9



HomeSafe Shutters

- Windows ■ Patio Doors ■
- Porches ■ Storm Protection ■

HomeSafe Rolling Shutters are the answer for home security, storm protection and weather protection-with good looks. HomeSafe rolling shutters have been installed over the country. From coast to coast and inner cities to the suburbs, satisfied customers rely on the high quality and dependable operation of HomeSafe rolling shutters.

HomeSafe rolling shutters give you a variety of choices in curtain styles, materials and colors. These are custom selected to meet your specific application, security protection, and aesthetic requirements.

Security with Good Looks

Visual barriers provide protection against break-ins, but often are unsightly. QMI, the makers of HomeSafe, have invested time and resources to design a rolling shutter that looks great and is a security barrier. When they are mounted on the outside they are totally invisible from the inside.

Patio and French Doors

Patio and French doors offer easy opportunities for break-ins, are notorious for drafts, and cause some of the biggest decorating dilemmas. HomeSafe rolling shutters are the perfect answer for patio and French Doors.

Window Walls

Gorgeous window walls, some rising three stories, are the focal point in many new homes. They are impressive beauty living with them can be another story. They provide little protection from heat and cold. During the day, sun damage to your belongings can be devastating. At night, people feel as if they live in a fishbowl. And attractive window treatments are nearly impossible to achieve.

HomeSafe rolling shutters are the answer. When they are down, they are neat and clean showcasing the beautiful design and woodwork of your spectacular window walls.

Screen Porches, Sun Rooms, Balconies

HomeSafe rolling shutters make these areas more livable and make you more comfortable. Rolling shutters become attractive walls when they are lowered, protecting you and your outdoor furniture from the wind and weather. In the up position, you'll enjoy the beautiful days, because your shutters won't even be noticeable.



SunSafe Shutters

- Reduces 85% of the sun's heat and damage
- Protects from golf balls
- See outside and still be protected
- Perfect security cover for window screens

SunSafe see-through roll down home shutters preserve your view while helping to ensure your security. Solid aluminum punched slat construction provides commercial grade security. SunSafe shutters are significantly better than traditional roll down sun screens or window screens which provide no security. SunSafe shutters stop up to 85% of the sun's harmful rays—slashing energy bills by as much as 50% while reducing furniture and carpet fading/discoloration. SunSafe shutters supplement burglar monitoring service by deterring break-ins and its patented "End Retention" slat technology prevents shutters from being pulled or forced out of sidetracks.

Available in seven attractive colors, SunSafe shutters are perfect protection for large window walls, porches and patio doors. They can be integrated into walls or soffits in new construction, or attractive box housing can be easily attached later.



Guarantee

It's a QMI

See pg 9



Protection from Golf Balls

Approved for 200+ Hurricane Winds. QMI is Different than any Other Rolling Shutters! See the Difference!

Visit us at: www.qmiusa.com/seethedifference

Authority Approval Chart						
Authority	AL6-T	AL6-E	AL2-R	AL2-E	AL3-R	AL3-E
IBC	●	●	*	●	*	●
IRC	●	●	*	●	*	●
TDI	●	●	*	●	*	●
FBC	●	●	*	●	*	●
FBC-HVHZ			*	●	*	●
DADE			*	●	*	●

* Product is now available.

Design Pressure Rating Chart						
psf	AL6-T	AL6-E	AL2-R	AL2-E	AL3-R	AL3-E
35	20'-0"	19'-6"	*	5'-1"	*	6'-0"
40	18'-5"	17'-11"	*	5'-1"	*	6'-0"
45	16'-11"	16'-5"	*	4'-11"	*	5'-10"
50	15'-9"	15'-3"	*	4'-9"	*	5'-8"
55	14'-8"	14'-2"	*	4'-7"	*	5'-6"
60	13'-10"	13'-4"	*	4'-5"	*	5'-5"
65	13'-1"	12'-8"	*	4'-4"	*	5'-3"
70	12'-5"	12'-0"	*	4'-3"	*	5'-2"
75	11'-11"	11'-6"	*	4'-1"	*	5'-1"
80	11'-5"	11'-0"	*	4'-0"	*	5'-0"
85	10'-6"	10'-6"	*	3'-11"	*	4'-11"
90	10'-2"	10'-1"	*	3'-10"	*	4'-10"
95	9'-10"	9'-9"	*	3'-9"	*	4'-9"
100	9'-6"	9'-5"	*	3'-8"	*	4'-8"
110	9'-3"	9'-1"	*	3'-7"	*	4'-6"
115	8'-11"	8'-6"	*	3'-7"	*	4'-5"
120	8'-9"	8'-4"	*	3'-6"	*	4'-5"
125	8'-6"	8'-1"	*	3'-6"	*	4'-4"

* Product is now available.

Above are maximum widths achievable for the best mounting conditions. Please refer to www.qmiusa.com/technical for specific technical information and mounting details.

QMIs are tested and approved in accordance with all current certification authorities to provide hurricane protection. QMIs pass all current state codes for hurricane protection.

We are approved by:

- IBC – International Building Code
- IRC – International Residential Code
- TDI – Texas Department of Insurance
- FBC – Florida Building Code
- FBC – HVHZ Florida Bld Code High Velocity Hurricane Zone
- Dade – Dade County

Engineering and testing approvals are available on request or on our website. Visit www.qmiusa.com/technical for technical information.

Selecting the Right Shutter For Your Application

Currently there are numerous wind load specifications established and accepted by different counties through out the U.S. There is no single adopted windload specification accepted, so each installation needs to check with the local county, state, or governing body to establish the correct wind load table. Check with your local building inspector for the applicable code.

QMI does not provide, or specify for construction, design criteria for windload design pressure specifications for any structure. A trained specialist or a qualified licensed structural engineer only should do these specifications.

Features Chart						
Feature	AL6-T	AL6-E	AL2-R	AL2-E	AL3-R	AL3-E
Single Wall	●	●				
Double Wall			●	●	●	●
Standard Wall		●	●	●	●	●
Thick Wall	●					
End Retention	●	●	●		●	
Low Clr. Hinge	●	●	●		●	
Std Euro Hinge				●		●
Balance Spring		●	●	●		●
Strm Bars Req				●		●
Profile Height	2.575"	2.575"	1.69"	1.57"	2.25"	2.3"
Weight ft ²	1.25 lbs	1.35 lbs	1.5 lbs	1.5 lbs	2.1 lbs	2.1 lbs

Maximum Width Chart						
Authority	AL6-T	AL6-E	AL2-R	AL2-E	AL3-R	AL3-E
International Building Code/ International Residential Code						
Grout Filled Concrete Block	240"/35psf	234"/35psf	*	74"/25psf	*	89"/25psf
Wood Frame	171"/35psf	171"/35psf	*	74"/25psf	*	89"/25psf
Florida Building Code						
Grout Filled Concrete Block	240"/35psf	234"/35psf	*	74"/25psf	*	89"/25psf
Wood Frame	171"/35psf	171"/35psf	*	74"/25psf	*	89"/25psf
Texas Department of Insurance						
Grout Filled Concrete Block	240"/35psf	234"/35psf	*	74"/25psf	*	89"/25psf
Wood Frame	171"/35psf	171"/35psf	*	74"/25psf	*	89"/25psf
Dade County – Florida Building Code High Velocity Hurricane Zone						
Grout Filled Concrete Block			*	61"/40psf	*	72"/40psf
Wood Frame			*	61"/40psf	*	72"/40psf

* Product is now available.

Above are maximum widths achievable for the best mounting conditions. Please refer to www.qmiusa.com/technical for specific technical information and mounting details.

PVC (Poly Vinyl Chloride)



QMI has a selection of over 100 different curtain profiles to fit any requirement you might have. They are in stock for immediate delivery. The following is a brief survey of curtain profiles for your application.

PVC (Poly Vinyl Chloride)

PVC profiles provide excellent protection against cold, heat and noise. They create a good visual barrier for security. Excellent scratch resistance.

Construction: Extruded double walled PVC.
Options: Galvanized steel re-bar for added strength.
Colors: White, Ivory, Beige and Grey.

Aluminum Roll Formed

Roll Formed Aluminum profiles provide good insulation against cold, heat and noise. They are excellent as a security barrier and provide good storm protection.

Construction: Aluminum roll formed with CFC-free foam insulation.
Options: Both standard and high density foam insulations are available.
Colors: White, Brown, Ivory, Beige and Grey.

Aluminum Roll Formed

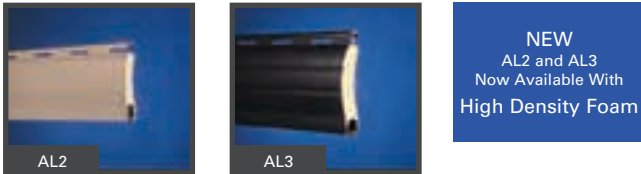

Steel Roll Formed

Roll Formed Steel provides the added strength of steel with the clean look of our other profiles. Our profiles are sprayed with special paints which resist rust, making them perfect for most environments.

Construction: Steel roll formed with CFC-free foam insulation.
Colors: White and Brown.

Steel Roll Formed



Extruded Aluminum/Single Wall

Our AL5-E profile is one of our most versatile profiles. The AL5-E can be punched with one of 5 styles for both security and vision. The AL5-E has a patented retention system so that the slats are restricted from being pushed out of sidetracks. It also rolls up in a more concentric roll, reducing the head room needed for the coil housing.

Our new patent pending AL6-E profile provides added strength for hurricane applications and maintains the features of the AL5-E. It comes in two wall thickness.

Construction: Extruded single walled aluminum.
Colors: White, Brown, Ivory, Beige, Bronze, Gray and Anodized.

Extruded Aluminum/Single Wall



Extruded Aluminum/Double Walled

Our extruded aluminum profiles are designed to withstand hurricane winds and they provide the highest level of security protection. These profiles may also be retained to restrict push out from heavy winds or forces.

Construction: Extruded double walled aluminum.
Colors: White, Brown, Ivory, Beige, Bronze and Anodized.

Extruded Aluminum/Double Walled



Alulux Roller Grille Sections

CD 78 and CD 88
CD 78 and 88 series is designed for the highest level of security where visibility is still required. CD 78 is 3 1/8" tall by 3/4" deep. CD 88 is 4" tall by 1" wide. Each punched opening is 3 1/2" x 1 1/2". PVC inserts are included for noise reduction. Polycarbonate inserts and steel inserts are available for added security.

Alulux Roller Grille Sections

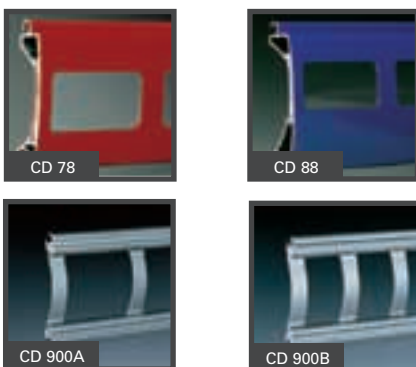

Transparoll

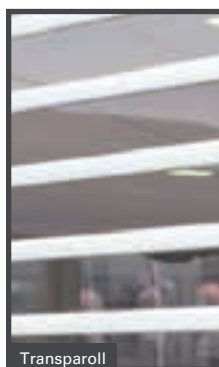

CD 900A and CD 900B

CD 900 series is designed for those applications that require a standard grille. CD 900 series is 3 7/8" tall by 1/2" deep. CD 900A has a mesh spacing of 4" and the CD 900B has a mesh spacing of 2".

Colors: Clear Anodized, Light Bronze, Medium Bronze, Dark Bronze, Black and Custom Colors.

Transparoll/Transparent Polycarbonate

Clear polycarbonate slats are perfect for maximum visibility and maximum protection. The polycarbonate slats are 6 mm thick which is 250 times stronger than glass. Each slat is linked together with an extruded aluminum rib which is integrally connected to the next slat.
Rib Colors: White, Brown, and Custom Colors.

From Your First Call...

QMI Makes Rolling Shutters Easy

Trained QMI sales representatives make it easy to select the right rolling shutter or grille for your application. We make rolling shutters easy. Our knowledgeable representatives walk you through the step-by-step selection process for designing the correct rolling shutter or grille.

QMI faxes you a written quotation which includes alternate controls and slat types so you can quickly compare the cost alternatives of the many choices available to you.

QMI also faxes you drawings of your selections which include all dimensions, side rail installation details, control details and locations. This quickly assures you that there are no surprises.

QMI's written quotation and drawings are great additions to your client presentations.

QMI gives quotes in hours not in days.

Box Housing Choices

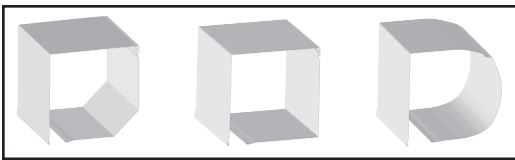

■ 45° Box Housing ■

6", 6.5", 7" 8" 10", 12" & 16"
Standard Colors

■ Square Box Housing ■

6", 6.5", 7" 8" and 10"
Standard Colors

■ Round Box Housing ■

6.5", 7" and 8"
White, Grey, Brown & Beige

Visit us at: www.qmiusa.com/technical to verify color, size and shape availability.

Standard Color

Standard color options are: from top to bottom—White, Brown, Ivory, Beige, Bronze, Grey and Clear Anodized.



Working With QMI Is Simple

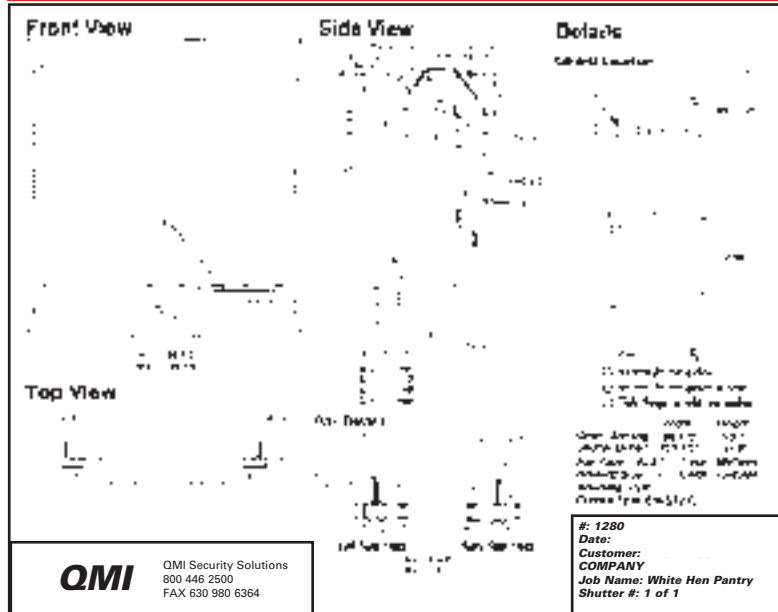

For more information on our locking and security features visit our web site or call

www.qmiusa.com 800 446 2500

Standard Controls

Manual Strap

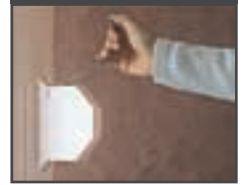

3-1 Strap Crank



Pole Crank



Motor Operated



"Security" Features

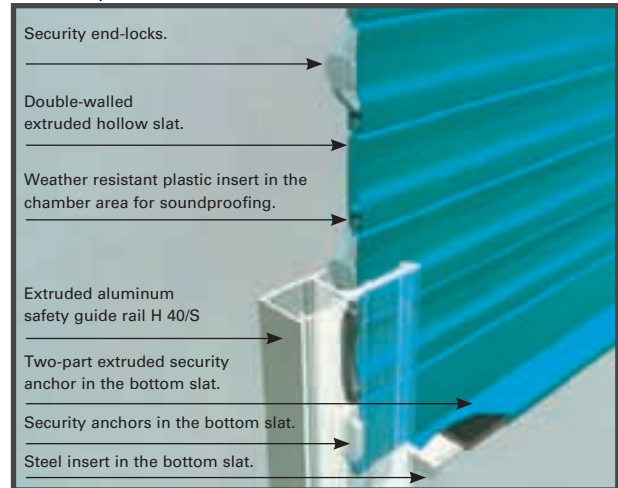

Anti-Push-Up Lock

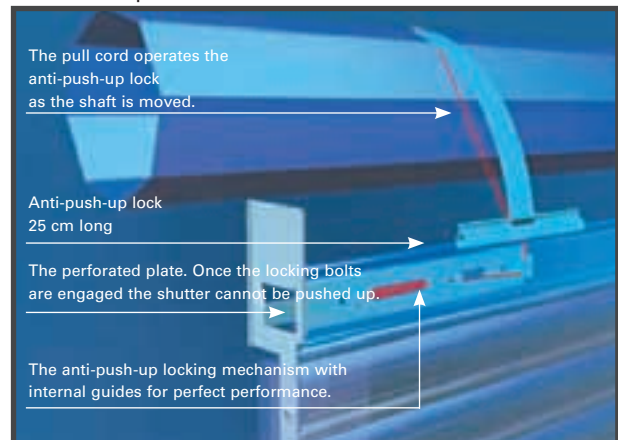

Introducing Our New Controls

The EZ Drive System

You can motorize your shutters at a fraction of the cost with our new EZ Drive System. Since it is all low voltage, there is no need for an expensive electrician and costly wiring. It is safe and easy for anyone to install.



Smart Drive

The SmartDrive Motor is a low voltage motor that easily installs on the inside of the shutter. Best of all it gives you peace of mind because your shutters can operate on a rechargeable battery, in case of an emergency.

The low voltage wiring can be easily installed on the interior of the building. No need for pipes or an electrician. The wiring connects to the SmartDrive's wall plate. The SmartDrive's Controller contains the batteries and slips easily into the wall plate enabling one SmartDrive Controller to control multiple shutters. It's Smart!

Operates in excess of 50 shutter operations in a single charge depending on the size of the shutters.

The EZ Power Pole

When installation of electrical power is difficult, or you want to retrofit your storefront with motorized shutters, QMI's EZ PowerPole is your answer. The EZ PowerPole conveniently stores anywhere and quickly plugs into any wall plug to charge the portable power pack. The EZ PowerPole quickly mates with the SmartDrive's power receptacle for a fully motorized shutter operation. No Electrician Needed!

Our new Smart Drive Low Voltage Motor

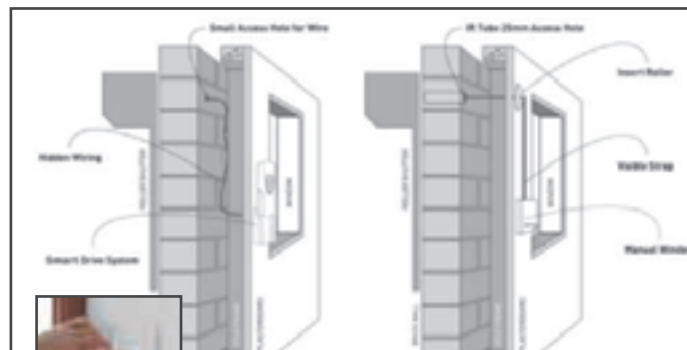

(far left) Controller slides into the wall plate.
(left) Push button controller and integrated battery.

Introducing the EZ Power Pole

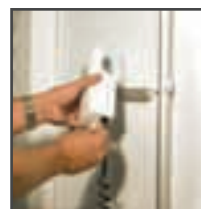

Simple Operation—
Just plug to charge.



Pole simply mates
with shutter



Stores anywhere

Our new Push-Up / Pull-Down Operation



Push-Up
Mid-Curtain Key Lock

Pull-Down Mid-Curtain Finger Slat

Push-Up / Pull-Down Operation

Our contained counter balance spring enables quick shutter installation with ease of use. Just push up or pull down and lock. Curtains have finger pull slats for ease of use. In-curtain locks or bottom locks with removable cores are available for most national lock manufacturers. Our patented Spring Stops cushion the shutter from banging at the top.

Standard Mounting Specifications

Visit www.qmiusa.com/technical for expanded architectural details and sections.
800 446 2500

Various Track Mounting Techniques

Side Tracks

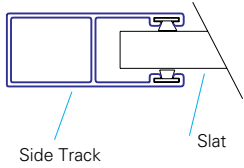

Not Drilled: Select "Not Drilled" when drilling needs to be done in the field due to unique applications.

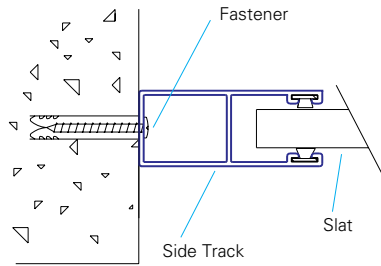

Recess Mount: Typical track attachment when attaching to any interior wall. Care needs to be taken to provide exact dimensions. (We recommend the angle mount below when possible.)

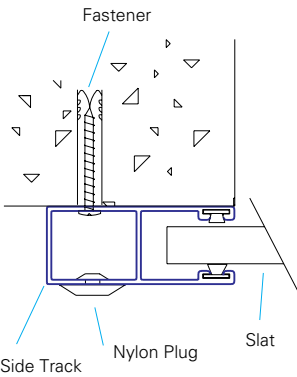

Surface Mount: Most common mounting application. Side track fits outside the rough opening.

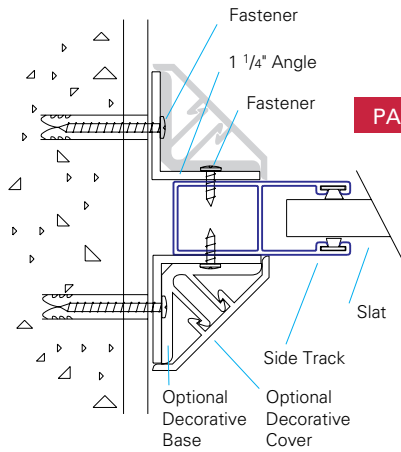

Angle Mount: Most desirable mounting technique when installing between walls or between jambs. The angles act as trim spacers so measurements are not so critical. Shutters should be made 1/2" less than the dimensions between walls or jambs.

PATENTED

Note: More Side Track Details Are Available

Sample Combination of Side Tracks Showing Storm Bars

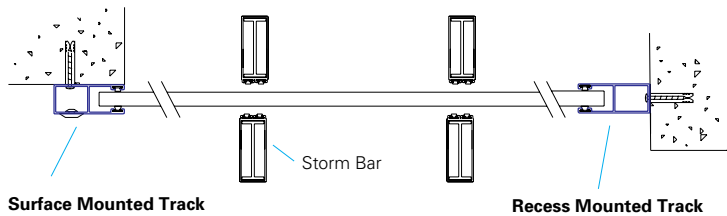

Storm Bars

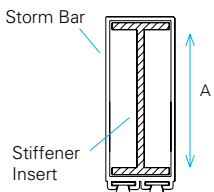

Sill Detail

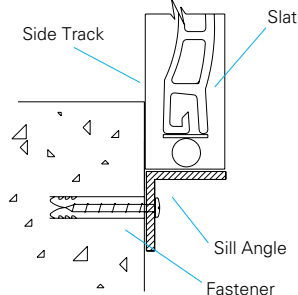

Storm Bar Width	A
Mini Storm Bar	2"
Maxi Storm Bar	2.5"

Standard Control Details

Strap Controls

Counter Style

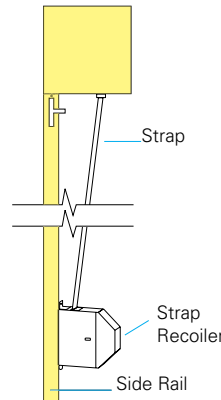

Through Wall Style

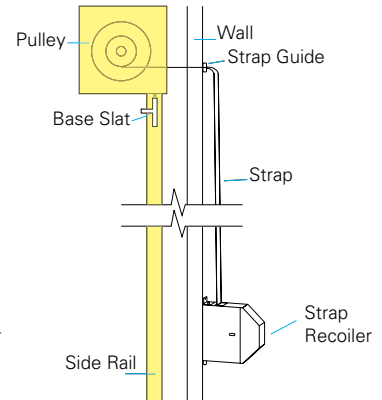

Crank Controls

Counter Style

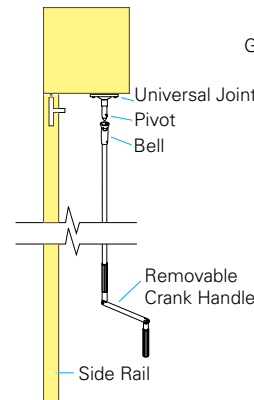

Through Wall Style

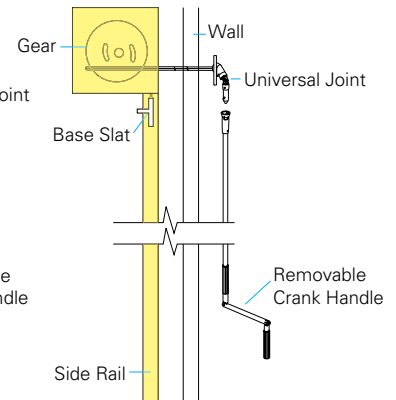

Electric Motors

Standard Motor

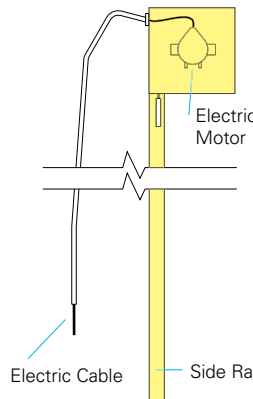

Motor With Manual Override

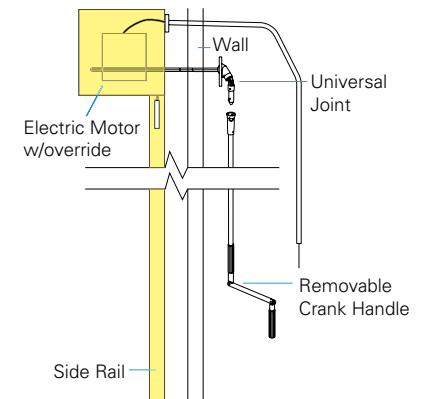

Note: More Control Details Are Available

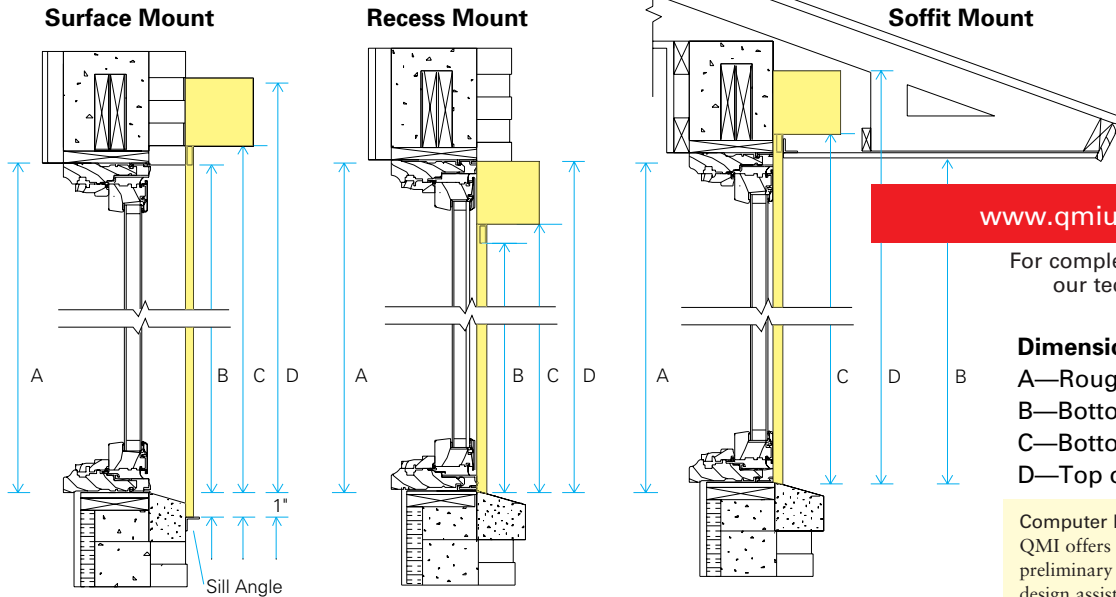

Note: If a sill angle is needed it is recommended to add 1" to dimensions

Curtain Type	Profile (Slats) Height	Lbs. per ft²	Lbs. per ft² w/re-bar	Track System For dimensions see charts below	Maximum Track Height for These Box Sizes							Max. Width	Max. Square Feet
					5.5"	6"	7"	8"	10"	12"	16"		
PVC													
PV2	1.57"	.65	.85	1, 2	35"	42"	77"	116"	187"	NA	NA	120"	40²
PV3	2.06"	.75	1.10	3, 4	NA	38"	55"	87"	157"	NA	NA	144"	65²
PV4	1.91"	.95	1.20	3, 4	NA	NA	38"	56"	95"	144"	NA	168"	85²
Aluminum Roll Formed—Standard Density Foam													
AL2	1.57"	.88	NA	1, 2, 9	34"	42"	74"	100"	174"	NA	NA	180"	81²
AL3	2"	1.1	NA	3, 4, 10,11	NA	NA	39"	62"	103"	160"	NA	180"	105²
Aluminum Roll Formed—High Density Foam													
AL2 H	1.57"	1.1	NA	1, 2, 9	34"	42"	74"	100"	174"	NA	NA	180"	81²
AL3 H	2"	1.6	NA	3, 4, 10,11	NA	NA	39"	62"	103"	160"	NA	180"	105²
Extruded Aluminum—Single Wall													
AL5-E	2.375"	1.25	NA	3, 4, 5, 10, 11, 12,13	NA	NA	70"	100"	144"	NA	NA	190"	129²
Punched/AL5-E	2.375"	1.0	NA	3, 4, 5, 10, 11, 12,13	NA	NA	70"	100"	144"	NA	NA	190"	129²
AL6-E	2.575"	1.25	NA	3, 4, 5, 10, 11, 12,13	NA	NA	65"	90"	160"	200"	NA	232"	160²
AL6-T	2.575"	1.5	NA	3, 4, 5, 10, 11, 12,13	NA	NA	65"	90"	160"	200"	NA	232"	160²
Extruded Aluminum—Double Walled													
AL2-E	1.57"	1.5	NA	1, 2, 9	34"	43"	77"	102"	172"	NA	NA	200"	105²
AL3-E	2.18"	2.1	NA	3, 4, 5, 10,11	NA	NA	50"	69"	117"	165"	NA	200"	105²
AL2-R	1.70"	1.75	NA	1, 2, 9	34"	43"	77"	102"	172"	NA	NA	200"	105²
AL3-R	2.25"	2.0	NA	3, 4, 5, 10,11,12,13	NA	NA	50"	69"	117"	165"	NA	200"	105²
Steel Roll Formed—Standard Density Foam													
ST2	1.57"	2.1	NA	1, 2, 9	34"	42"	74"	100"	174"	NA	NA	190"	95²
ST3	2"	2	NA	3, 4, 5, 10,11	NA	NA	39"	62"	111"	160"	NA	190"	129²
Grilles													
CD 78	3.125"	1.9	NA	6	NA	NA	NA	NA	80"	128"	220"	200"	215²
CD 88	4"	2.2	NA	5	NA	NA	NA	NA	55"	120"	206"	210"	250²
CD 900A	3.875"	1.45	NA	5, 6	NA	NA	NA	NA	78"	128"	300"	180"	108²
CD 900B	3.875"	1.65	NA	5, 6	NA	NA	NA	NA	78"	128"	300"	180"	125²
Transparent Polycarbonate													
LE 4	2.7"	2.5	NA	7,8	NA	NA	NA	NA	NA	90"	170"	300"	200²

Note: Wind load testing and local zoning approvals available upon request.

Standard Track Chart

System/Style	X	Y
1 Mini/Standard	2.125"	0.9"
2 Mini/Deep	2.625"	1.0"
3 Maxi/Standard	2.5"	1.1"
4 Maxi/HW	2.5"	1.125"
5 SMaxi/STD	3.0"	1.06"
7 Trans/U shaped	3.0"	2.25"
8 Trans/STD	4.75"	2.25"

Retained Track Chart

System/Style	X	Y
9 Mini/Standard	2.75"	1.125"
10 Maxi/Standard	3.0"	1.125"
11 Maxi/HW	3.0"	1.15"

Spring Stop Track Chart

System/Style	X	Y
12 Maxi/Standard	3.0"	1.125"
13 Maxi/Retained	3.5"	1.125"

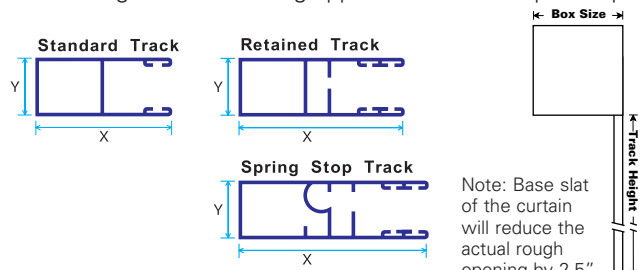

Architectural Specifications 10712 Exterior Overhead Coiling Shutters

PART 1—General

1.01 Summary

- A. Section includes exterior overhead coiling storm and security shutters.
- B. Related Sections:
1. Section 08710: Furnishing lock cylinder.
 2. Division No. 16—Electrical: Electrical power, conduits, field wiring and disconnect switches for motorized shutters.

1.02 Submittals

- A. Procedure: Comply with requirements of Section 01330: Submittal Procedures.
- B. Product Data: Submit manufacturer's complete product data for all specified components, including specifications, finish information and installation instructions.
- C. Shop Drawings: Submit shop drawings showing layout, sizes and types, product materials, components and accessories, fabrication data, operation and wiring diagrams for motor driven operators, finishes, rough-in dimensions, anchorage and installation requirements and details.
- D. Samples: Manufacturer's standard array of colors for selection by Architect.
- E. Quality Assurance Submittals:
1. Test Reports: Certified test reports showing compliance with specified requirements.
 2. Certificates: Manufacturer's certification that design criteria meets specified requirements.
 3. Operating and Maintenance Instructions: Submit detailed maintenance requirements and operating instructions.
 4. Warranty: Submit specified warranty documents.

1.03 Quality Assurance

- A. Installer Qualifications: Use only manufacturer's factory trained installers or qualified licensed installers approved by shutter manufacturer.
- B. Regulatory Requirements:
1. Comply with all local and governing code requirements.

2. Unless required otherwise, fabricate to withstand wind loads that have the same rating as component and cladding of walls.
- C. Pre-Installation Conference: Conduct a pre-installation meeting to verify project installation and coordination requirements, field conditions and manufacturer instructions.

1.04 Delivery, Storage and Handling

- A. Procedure: Comply with requirements of Section 01650: Product Delivery Requirements.
- B. Deliver components in manufacturer's original, unopened, undamaged containers with identification labels intact. Store components protected from harmful weather conditions and damage from other construction activity.

1.05 Project Conditions

- A. Field Measurements: Verify actual measurements of openings by field measurements before fabrication. Show recorded measurements on shop drawings.

1.06 Warranty

- A. Manufacturer's Warranty: Submit, for owner's acceptance, manufacturer's standard warrant document executed by an authorized company official.
1. Warranty Period: _____ years.

(Specifier Note: Refer to manufacturer's product data or consult with manufacturer's representative for warranty information.)

PART 2—Products

(Specifier Note: Where items occur in brackets () select item desired for project.)

Manufacturer

QMI
1661 Glenlake Ave
Itasca, Illinois 60143
(800) 446-2500 FAX (630) 980-6364

2.02 Materials

- A. Shutter Components:
1. Slat Types:

(Specifier Note: Select one of the material a. selections as follow.)

- a. PVC Slats: Exterior type UV stabilized Extruded polyvinyl chloride: Style: (PV-2, PV-3, PV-4) with slat reinforcement every (0,1,2,3) slats. Color: (White, Ivory, Beige, Grey).
- a. Aluminum Foam-Filled Slats: Aluminum, 3005 H26 alloy with polyurethane foam insulation core. Style (AL2-A, AL2-H, AL3-A, AL3-H). Color: (White, Brown, Ivory, Beige, Grey, Bronze, Clear Anodized).
- a. Aluminum Double Walled Extruded Slats: Aluminum, 6063-T5 alloy. Style (AL2-E, AL3-E, AL2-R, AL3-R). Color: (White, Ivory, Beige, Bronze, Clear Anodized).
- a. Aluminum Singled Wall Extruded Slats: Aluminum, 6063-T5 alloy. Style AL5-E, AL6-E, AL6-T (Solid, Punch Style (11, 21, 31, 41, 51)). Color: (White, Brown, Ivory, Beige, Grey, Bronze, Clear Anodized).
- a. Grill Slats: Style (CD-800, CD-802, CD-78, CD-88, CD-900A, CD-900B). Color (Clear Anodized Light Bronze, Medium Bronze, Dark Bronze, Black or Custom Colors).
- a. Transparoll: Transparent polycarbonate slats with extruded aluminum linking ribs. Color: (White, Clear Anodized (Linking rib only)).
2. Bottom Bar: Extruded aluminum, 6063-T5 alloy, 0.050 inch wall thickness.
3. Operation: (Manual) (Motor Operated).
 - a. Manual operator type: (Pull strap-recoiler, 3/1 crank-strap recoiler, gear and crank handle, spring push-up/pull-down.).
 - a. Electric Motor Operator type: Single phase 110V-60Hz UL recognized. Motor Model/Size_____. Provide back-up battery power pack. Provide manual override capability allowing manual operation in case of power outage.

(Specifier Note: Select a. above or a. below to coordinate with selection of 3. Above.)

(Specifier Note: Battery pack and manual override capability above are optional features. Delete if not required.)

4. End Caps: Die-cast aluminum. Style: (4 sided, 5 sided, round). Color: To match slats.
5. Box Housing: .040 roll formed aluminum. Style (4 sided, 5 sided, round). Color: To match slats.
6. Side Tracks: Aluminum extrusion, 6063-T5, lined with insulating woven polypropylene runners. Color: To match slats.
7. Mounting: (Surface, jamb, recess, angles)
8. Stormbar Assembly: Aluminum extrusion. Style and quantity per manufacturer's design to comply with all certification and test reports in section 1.02 part E. above.

(Specifier Note: If stormbar(s) not required, delete.)

PART 3—Execution

3.01 Examination

- A. Verify conditions of substrates to determine if acceptable for shutter installation in accordance with manufacturer's instructions. Correct all unsatisfactory conditions prior to commencing shutter installation.

3.02 Installation

- A. Install track and all shutter components to comply with project shop drawings and manufacturer's written instructions.
- B. After installation test and adjust shutter to operate properly and free from distortion.

3.03 Cleaning

- A. Clean installed components in accordance with manufacturer's instruction prior to acceptance. Remove all debris remaining, due to installation, from this installation.

3.04 Protection

- A. Comply with manufacturer's recommendations and protect completed shutter installations from damage during remaining construction so as not to void warranty.



Manufacturer of Roll-a-way Brand Products



www.qmiusa.com 800 446 2500