

10 28 19/AME  
BuyLine 6154

# American

SHOWER DOOR



OUR DESIGN IS AN ART

# ◆ TABLE OF CONTENTS ◆

**A**ERICAN SHOWER DOOR CORPORATION is the premier manufacturer of shower enclosure systems. Since 1935, we have supplied products worldwide to customers who share in our commitment to maintain the highest levels of quality, design and service.

You may choose from an unlimited selection of creative products. Select solid brass (with your choice of plating), anodized aluminum finishes or stainless steel metal, to combine with hundreds of glass options, from 1/4" to 3/4". Custom water-jet pattern cuts for your metal or glass are our specialty. Whether you need a standard product or a creative new design, call on AMERICAN SHOWER DOOR to produce the exact product to fit your construction.

<i>Product Category</i>	<i>Seen on Page</i>
Crystal Collection .....	3-7
Solid Brass .....	8-11
Aluminum Doors and Enclosures .....	12-19
Stainless Steel .....	20
Specialty Items .....	21
Specification Guide .....	22-23

Credit with the production of this catalog goes to all of our fine glass dealers who have submitted photography. Several photos were submitted by the following companies: Granite State Glass in Winnisquam, New Hampshire; Chuck's Glass in Montrose, Colorado; Glassworks in Waterbury, Vermont; Seattle Shower Door in Seattle, Washington; Alpha Mirror and Glass in Eagle, Colorado; S.N. Bartlett in Chicago, Illinois; Paige Structural Glass in San Francisco, California; Colorado Glass and Shower in Montrose, Colorado; Palmetto Glass and Mirror in Charleston, South Carolina; Total Glass Works in Agoura Hills, California; Broadway Glass in Long Beach, California; Kuritzky Glass Co. in Mt. Kisco, New York.

## *Warranty*

AMERICAN SHOWER DOOR offers a lifetime warranty to the purchaser of any new aluminum shower door or any new aluminum shower door part manufactured by AMERICAN SHOWER DOOR that the product or part shall be free from defects in material and workmanship. AMERICAN SHOWER DOOR agrees to repair or replace any defective part at no charge to the purchaser within the warranty period. This warranty does not cover damage resulting from normal wear from usage, loss, alteration, accident, misuse or abuse, or lack of reasonable care in either the installation or use of the product or parts.

No responsibility is assumed by AMERICAN SHOWER DOOR for any special, incidental or consequential damages. If there is any defect in workmanship or material, AMERICAN SHOWER DOOR's liability is solely limited to replacement of material as stated. AMERICAN SHOWER DOOR reserves the right to decide if the defective part or product is to be replaced or repaired. Any and all claims for replacement and/or rework must be pre-approved by AMERICAN SHOWER DOOR. Labor rates will be credited at a rate approved by AMERICAN SHOWER DOOR.

It is expressly agreed that this warranty is the exclusive and only warranty made by AMERICAN SHOWER DOOR and is in place and in lieu of all express and implied warranties of merchantability and fitness for a particular purpose.



# ◆ CRYSTAL COLLECTION ◆

American Shower Door

presents

## *The Crystal Collection*

Designed for 3/8", 1/2" and 3/4" glass, this brings you to the cutting edge of custom engineering – highlighting our unique **Crystal Collection** designs. Designed to your specification, we offer a wide range of custom finishes on extrusions of architectural brass, stainless steel or anodized aluminum. Elegant hardware options on the following pages are available for doors and enclosures. Leakproof, steam or as a water barrier, you can feel and see the difference with your quality AMERICAN SHOWER DOOR products.



*A stylish header is a welcome ▲ accent for oil-rubbed bronze with clean pivots. Bottom channel may be buried or surface mounted.*



▲ *As seen in our previous catalog, this CRYSTAL COLLECTION pivot door with oil-rubbed bronze on architectural brass is a magnificent enclosure.*

### American Shower Door

6920 E. Slauson Avenue / City of Commerce, CA 90040 / 800-421-2333

### CRYSTAL SPECIFICATIONS

**Glass:** 3/8", 1/2" or 3/4" tempered. All glazing material shall meet or exceed ANSI Z97.1 – 2004 and CPSC Standard 16 CFR 1201 Category I and II.

**Extrusions:** Extruded shapes shall be either 385 architectural bronze, specification AS-1567-38D; or aluminum 6463-T5 or 6063-T5 alloy depending on application, or formed 304 stainless steel.

**Hardware:** Heavy-duty solid brass hinges with swing options; leakproof option includes screw cover plates for a smooth finish. Handles: solid brass, polished stainless steel or as specified. Heavy-duty ball bearing roller system on enclosures. All ASD screws are rustproof stainless steel.

**Finishes:** All solid brass (see brass page 9) or aluminum (see aluminum page 12) specifications in this catalog.

*American*  
SHOWER DOOR

# ◆ CRYSTAL COLLECTION ◆



▲ Clips hold the panels in place when the door swings from the wall.

▼ Curved doors - a luxurious focus



▲ The AMERICAN SHOWER DOOR hinge jam completes a massive steam shower.

▼ A transom in the door of this steam unit features 3-position stops.



# ◆ CRYSTAL COLLECTION ◆



*Pivots work well ▲ in wide and tall doors.*



CRYSTAL COLLECTION ▲  
*steam room with a transom and sky high panels*



▲ *Special hinges are designed exclusively for arch openings in steam showers. Antlers through the glass make a unique door pull.*



3/8" or 1/2" glass compliment the frameless **Crystal Collection** enclosures. Available in anodized aluminum or solid brass ~ finished to your specification.

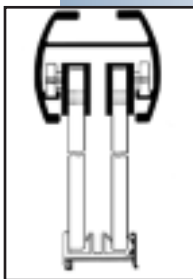

**853** Aluminum Enclosure

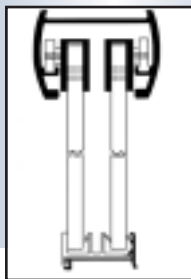

**953** Brass Enclosure

*A work of art - custom etched glass and self centering pewter on brass hinges* ▶



# CRYSTAL COLLECTION ◆ HARDWARE ◆



WALL MOUNT



135-DEGREE GTG



180-DEGREE GTG



JAMB TO GLASS



PIVOT WITH HEADER  
(HEADER OPTIONAL)



PIVOT WITH SILL  
(SILL OPTIONAL)



BACK SIDE OF PIVOT

*A*merican Shower Door sets the industry standard for quality and design.

## *Our Brass Hinges*

Adjustable for precision installation

Centered or offset backplates

Beveled edges and radius corners on most models

Standard angles always available

Custom angles made for your needs

Special hinges for arched-top steam doors

Self-centering, 0-degree stop or 5-degree offset

Leakproof option/steam tight with jamb

Hinges for 3/8", 1/2" or 3/4" glass

Pivots may be integrated into header and sill or direct ceiling/sill mounted

All finishes available

## *Our Brass Clips*

Available as 2" x 2", full 3" x 4" hinge profiles or custom sizes

Choose beveled or flat edges

Custom angles made for your needs

Custom designs and shapes available for your project

## *Our Handles*

Most through-the-glass handles and towel bars are SOLID brass or stainless steel

All combinations and finishes available

We have a variety of knobs, or will custom fit yours to work on the glass



▲ *Any shape transom you want - Transom pivots allow three stopping positions. Available as wall mount, glass-to-glass or special angles.*

Hinges

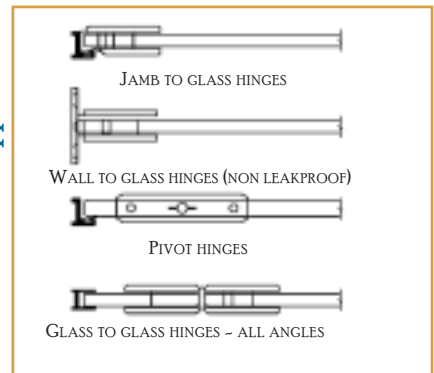

Door Strike Options

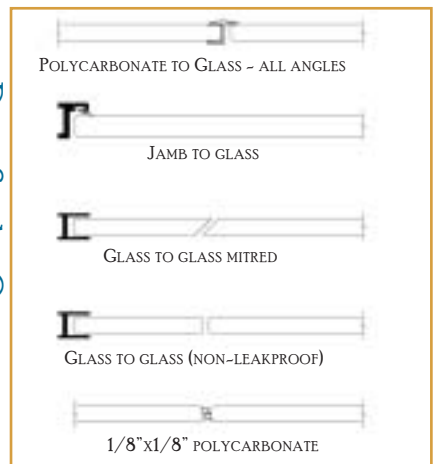

▶ *Special hinges, shown here, are designed exclusively for arch openings in steam showers.*



*American*  
SHOWER DOOR

# CRYSTAL COLLECTION ◆ HARDWARE ◆

All hardware is fine brass, plated to match your design. Select knobs, pulls, towel bars and robe hooks from our standard collection, or ask us to find something special just for you.

**Concerto**  
by portals



**Symphony**  
by portals



**Wood**



Simple wood handles work for Sauna applications.

**Counterpoint**  
by portals



## C-Pull Collection



**Solid Brass Hinges and Handles** ▲ plated to your choice of finish including brass, chrome, 24K gold, pewter, polished or brushed nickel, copper, oil rubbed bronze, antique brass or any custom finish of your choice.



▲ **Standard Knob Options**

# ◆ SOLID BRASS ◆

The *Vintage Solid Brass Collection*, a trademark of the AMERICAN SHOWER DOOR tradition, incorporates 3/16" to 3/8" glass-hinged doors and sliding enclosures using framed or frameless systems.

Doors and panel systems with traditional fully-framed designs or contemporary frameless glass panels enhance the luminescent metal finishes. Fine architectural brass is cleaned, polished, buffed and plated to an exquisite custom finish of your choice. Using clear or decorative glass patterns, with an option of heavy glass panels, this program is another opportunity to design installations exactly to your specifications.

*Framed door with Chrome on Brass  
▼ extrusions and mitred panels*



▲ *Polished Brass using  
traditional, fully framed panels*

*Hinged  
transom*



*Pivot  
transom*



*Grill  
in or above  
a door  
or panel*



*American*  
SHOWER DOOR



# ◆ SOLID BRASS ◆

10 28 19/AME  
BuyLine 6154



◀ *Framed beauty  
in Brushed Brass*



*Double corner  
construction  
ensures that  
solid brass frames  
will last into  
antiquity.*



◀ *1/4" Polished  
Copper or Brass  
frameless  
piano-hinged doors  
are nearly  
invisible.*



▲ *Framed door with framed panels -  
door, panels and grid work  
available in aluminum or brass*

## American Shower Door

6920 E. Slauson Avenue / City of Commerce, CA 90040 / 800-421-2333

### ASD BRASS SPECIFICATIONS

**Glass:** 3/16" to 3/4" tempered. All glazing material shall meet or exceed ANSI Z97.1-2004 and CPSC Standard 16 CFR 1201 Category I and II. Clear, obscure, etched, patterned or custom option.

**Extrusions:** Extruded shapes shall be 385 architectural bronze, specification AS-1567-38D.

**Hardware:** Classic Piano Hinge; handles are solid brass, polished stainless steel, or as specified. Heavy-duty ball bearing enclosure roller system. All ASD screws are rustproof stainless steel.

**Finish:** Chrome plated brass – brass shall be polished, buffed, degreased, and then plated; nickel plate QQ-N-290, Class 1, Type VI copper flash plus .0003 bright nickel. Chrome plating per QQ-C-320, Class 1, Type 1 decorative plating, bright chrome 0.00001. Baked enameled brass shall be polished, buffed, degreased, hand wiped and baked enameled at minimum 300F.

**Standard brass finishes include:** Polished or brushed chrome, enameled brass, pewter, antique brass, polished or brushed nickel, oil rubbed bronze, 24K gold or a custom finish of your choice.

*American*  
SHOWER DOOR

# ◆ SOLID BRASS ◆

**V**intage Brass doors may be accented with framed or frameless panels.



*The Polished Brass door and in-line panel display the finest traditional look of fully framed solid brass.*

*A mitred buttress corner gives a contemporary look to a classic design in Polished Brass.*



*Framed Slider with framed panels*

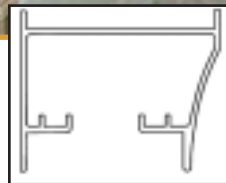

453 Header



*Brass enclosure with 1/4", 3/8" or 1/2" glass*

**V** using 1/4" glass, choose a framed or frameless enclosure with the elegance of real brass. A fully framed panel or frameless panels may be added. Solid brass towel bars and knobs are optional in the rail or through the glass.

# ◆ SOLID BRASS ◆

10 28 19/AME  
BuyLine 6154

UNIQUE CREATIONS

*"Any New Ideas?"*

Special credit on this page to:  
Alpha Mirror & Glass in Eagle, Colorado; S.N. Bartlett in Chicago, Illinois; and  
Paige Structural Glass in San Francisco, California



*Crossbows of hand pounded brass are featured in this 3/8" glass with framed solid brass. Custom plating completes the rugged design.*



◀ *Pure elegance with custom extrusions framing and dividing the glass.*



*Custom rails, grills and sand-blasted glass for the ultimate elegant home.*

▶ *No, it's not a wooden interior door, it's a custom shower door with a custom finish.*



*American*  
SHOWER DOOR

# ◆ ALUMINUM ◆



In 1935, AMERICAN SHOWER DOOR began making shower doors for water retention. Over the years, we have maintained the integrity of a waterproof system integrated with the beauty of the finest shower doors in America. Our extensive product line invites you to choose exactly the right application – for you!

## American Shower Door

6920 E. Slauson Ave. / City of Commerce, CA 90040 / 800-421-2333

### ALUMINUM SPECIFICATIONS

**Glass:** 3/16" or 1/4" tempered. All glazing material shall meet or exceed ANSI Z97.1 – 2004 and CPSC Standard 16CFR 1201 Category I and II.

**EXTRUSIONS:** Extruded shapes shall be aluminum 6463-T5 or 6063-T5 alloy depending on application.

**Hardware:** Aluminum, solid brass, polished stainless steel or as specified. Aluminum piano-hinged and stainless steel pivot bolts. All ASD screws are rustproof stainless steel.

**Finish:** Brite dip anodized aluminum – 6463-T5 alloy to be selectively A1 buffed to AA-C31-A21 brite dip silver specification; and AA-C31-A23 brite dip brass, tawny brass specification, or AA-M30-C31A24 satin nickel anodized specification. Satin anodized aluminum – 6063-T5 alloy to be anodized to a commercial AA-C22-A21 satin silver. Powdercoat – modified polymer to be thermo set and cured at a minimum 400F as per AAMA – 603 specifications.

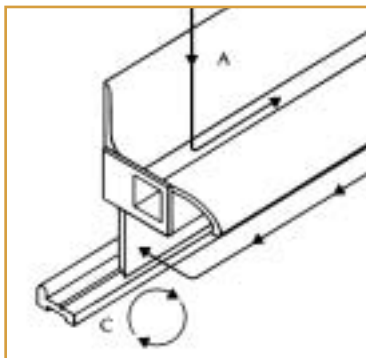

#### TRIAD FLOW CONTROL (TFC)

Crucial to our water tight design is our three point system.

- A. The drip shield directs water flow and redirects water off the panel through its deep and narrow gutter.
- B. Squeegee deflects water bounce.
- C. Dam strip seals off water buildup.

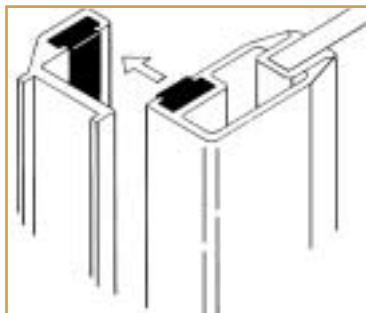

#### CONTINUOUS MAGNETIC SEAL (CMS)

Since its introduction in the late 1970s, our continuous magnetic seal system has set the standard for maintenance and performance.

*Standard handle for frameless door with magnet*



*Ultra handle for framed door*



#### Two Rail sizes for framed aluminum doors

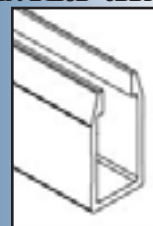

**200**  
(1-3/16" x 5/8")

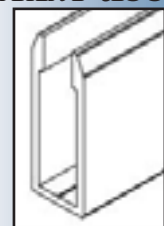

**355**  
(1-5/8" x 5/8")



# ◆ DOORS ◆

10 28 19/AME  
BuyLine 6154

## Classic

### 220

The durability and symmetry of the continuous piano hinge with the (CMS) and (TFC) systems found on all our framed doors.



Piano Hinge



AVAILABLE WITH ADJUSTABILITY (UP TO 1") OR CUSTOM FIXED JAMBS

## Magnum

### 212 & 202

Adjustable framed pivot door allows for simple adjustments between top and bottom pivot points.

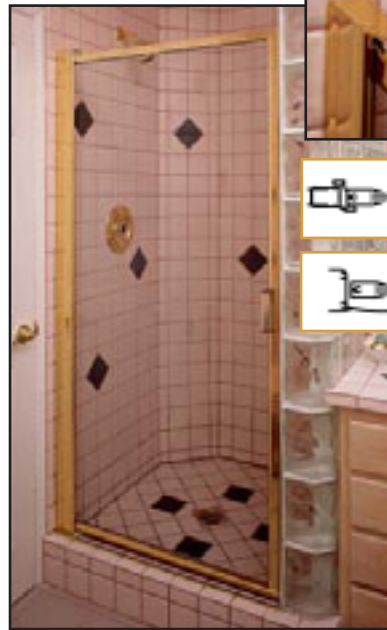

Adjustable pivot system



202



212

USING THE 200 BEVELED RAIL, THE MAGNUM HAS UP TO 2" OF ADJUSTABILITY. THE 202 FRAMED PIVOT DOOR ELIMINATES THE WIDE PIVOT JAMB, OFFERING UP TO 1" OF ADJUSTMENT.

## Elite

### 502 PIANO HINGE

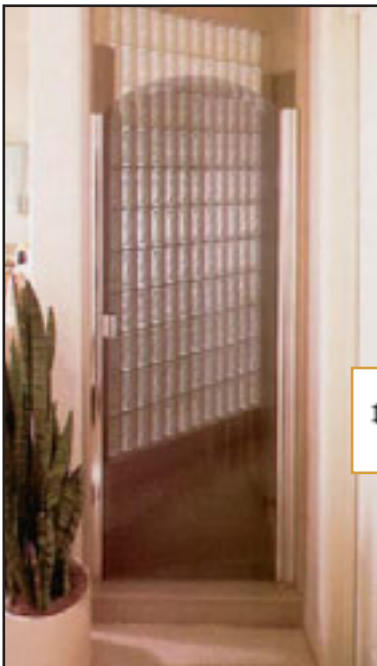

Encompassing an elegant contemporary look of invisibility, this trim frameless piano hinge door is shown with an optional beveled top.

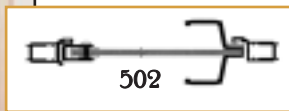

502

AVAILABLE WITH ADJUSTABILITY (UP TO 1") OR CUSTOM FIXED JAMBS.

## Max

### 353 PIVOT 355 PIANO HINGE



Maximum strength in a heavy-duty piano hinged door. Often used for steam rooms up to 36" x 96". For extra wide openings up to 43", use our Atlas pivot door with wide rails. Both adaptable as ADA handicapped with 36" opening and no barriers.

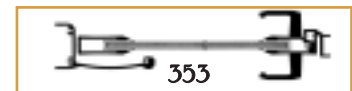

353

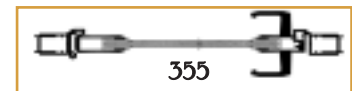

355

AVAILABLE WITH 1 3/4" ADJUSTABILITY ON PIVOT DOOR OR UP TO 1" ON HINGED DOOR.

# ◆ DAYLITES ◆

Replacing walls with panels of glass incorporates the essence of the “daylite” shower. Whether using swing or sliding doors, the addition of panels to one or more sides of the shower provides a light, pleasant environment of architectural beauty.

Panels may be “framed,” as we use in our traditional “100 Series,” for a maximum exposure of extruded metal in your choice of finish. The more contemporary frameless panel systems have the profile of less metal, offering mitred glass corners and a single wall extrusion.



*Framed door with frameless panels ▲  
- piano hinge 5100 SERIES Brite Dip Brass  
with transom*



*▲ Piano hinge 100 SERIES,  
fully framed panels and roof*

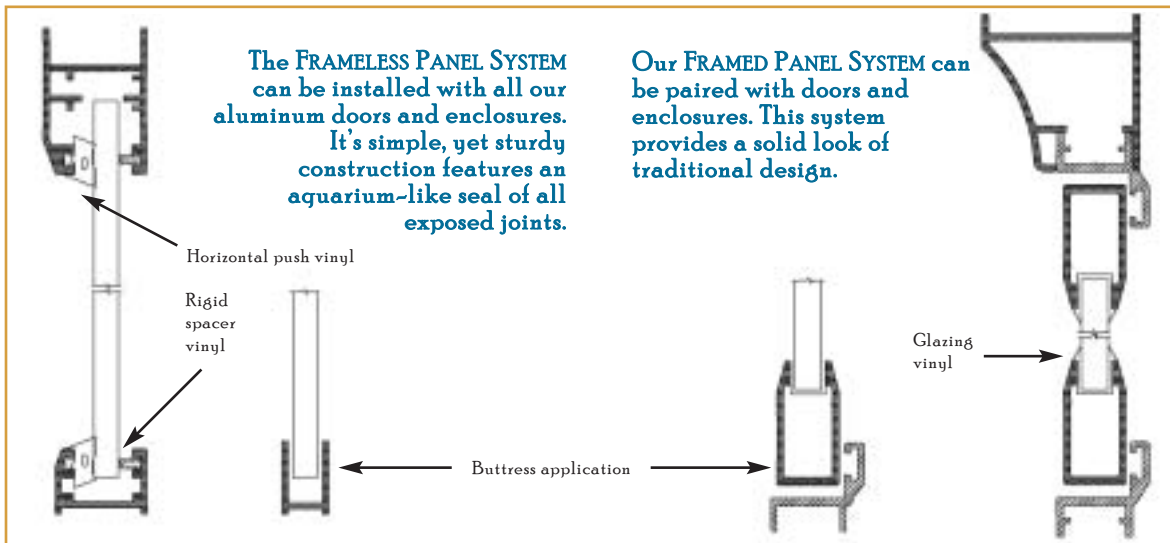

# ◆ DAYLITES ◆



semi-frameless (502) doors with 1/4" glass may be paired with many panel and hardware options.



5000 SERIES *semi-frameless door and panels.*  
*Glass panels may be mitred or with posts as shown.*



▲ *When the door opens, you have "frameless" 1/4" glass. Standard handles work well, or add a through-the-glass pull or towel bar from our CRYSTAL COLLECTION.*



*Even big showers can be semi-frameless and open. Mitred corners with 1/4" glass are cost effective and contemporary.*

# ◆ DAYLITES ◆



*A classic 5100 SERIES can fit anywhere - ▲ and be steam - when it is custom made by AMERICAN SHOWER DOOR.*



*▲ Our 5100 SERIES framed piano hinge daylites may be engineered in Brite Dip Brass with an optional post at the corner as shown here.*



*Framed pivot doors with obscure glass are an AMERICAN classic. Our 2100 SERIES neo-angle is shown with a panel towel bar.*



*▼ Framed doors are elegant installations.*





# ◆ DAYLITES ◆

10 28 19/AME  
BuyLine 6154



3100 SERIES  
with  
355 RAIL in  
the door  
provides  
strength  
for tall  
and wide  
showers or  
steam  
rooms.



Off angles - extra panels -  
2/3 neo angles - custom glass -  
showers designed to fit your space. ▼



▲ Symmetrical design creates an  
"orderly" pattern using  
100 SERIES framed panels.



►  
Standard  
or custom  
Powder  
Coat  
finishes  
are a  
striking  
addition  
in the  
shower -  
a gold  
handle  
accents  
this  
black  
unit.



*American*  
SHOWER DOOR

# ◆ ENCLOSURES ◆

**T**he most widely used shower door product in America is the sliding tub and shower enclosure. Decorative yet durable, our enclosures meet the high standards of all AMERICAN SHOWER DOOR products. Using minimal space for maximum function, they combine with side panels or overhead transoms to fill large or small spaces.

Glass thickness may vary from 3/16" to 1/2" (as seen on page 5 in our CRYSTAL COLLECTION) using artistic patterns, etched designs or beautiful clear clean glass. Selecting anodized aluminum or architectural brass, you have an unlimited rainbow of metal finishes.

## CLOSED TRACK (CT)

Useful for extra durability and strength, the closed track offers you the option of a very sturdy unit. Always used on the 272 steam enclosure to assure the tight fit necessary for functionality.

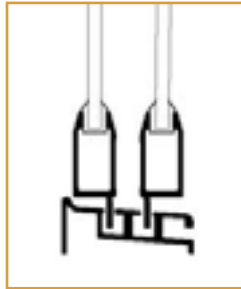

## OPEN TRACK (OT)

The easy-to-clean open track replaced the hard-to-clean "E" track in the 1970s. Today this sturdy and stable system with 4" tough nylon guide and efficient open "L" track make our enclosures safe and virtually maintenance free.



## Frameless Triple Sliding Enclosure



**T**he three-panel TRIPLE SLIDING ENCLOSURE adds an extra 15% clear opening on your shower. (This translates to 9" on a 60" tub.) Using 1/4" or 3/8" glass, through-the-glass solid brass hardware is standard.

Available in BDS, BDB, SNA and PC.

### Triple Sliding Enclosure

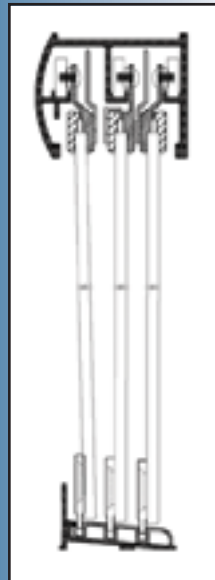

1/4" glass  
Patent Pending

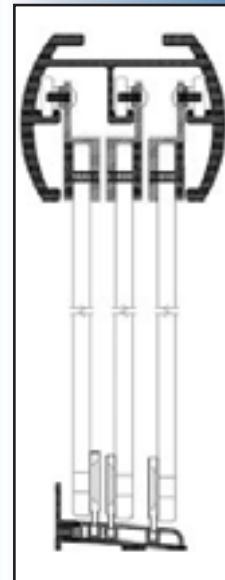

3/8" glass  
Patent Pending

# ◆ ENCLOSURES ◆

10 28 19/AME  
BuyLine 6154

## Tropic 272



*Attractive standard towel bar is optional.*

**T**he TROPIC 272 is a true steam sliding enclosure. S-vault jambs and brushed pile seals give you a tight steam application where a sliding enclosure is the best site application. A framed unit using 3/16" or 1/4" glass, this design is available in BDS, BDB or powder coat colors. Handles in the rail complete the standard accessory.

## Starlite 703

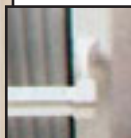

*A towel bar is standard on all aluminum enclosures.*

**A** lighter unit than the 253, the STARLITE 703 features standard 1" rails and offers a quality installation for the price sensitive application. Available in Satin, BDS, BDB or Powder Coat.

## Classic 253

*The top header is extra strong to eliminate flex and vibration.*



**O**ur CLASSIC 253 enclosure is clearly the class of the enclosure industry. Distinctive double sliding panels, framed with mitred 200 beveled rail, define elegance in enclosure design, with optional S-jambs or closed track. Available in all aluminum finishes.

## Elite 806

*The 806 header is strong yet unobtrusive for a quietly elegant enclosure.*



**E**ngineered to excellence, the ELITE 806 offers the ultimate options in a 1/4" frameless enclosure. Using the finest technology, the 806 incorporates S-jambs, improved tracks, guides and bumpers to create another fine product. *Through-the-glass hardware is a recommended upgrade.* All aluminum finishes are available.

*American*  
SHOWER DOOR

# ◆ 100% STAINLESS STEEL ◆

**S**tainless steel – the ultimate in strength and durability – now performs as a shower enclosure. Manufactured with formed 304 STAINLESS, the product reflects the futuristic sheen of brushed or polished stainless steel.

The “304” series of framed piano hinge door and panel systems is glazed with 1/4” glass and always comes with a matching through-the-glass handle or towel bar. Available for shower or steam applications, with adjustability as needed for conditions, AMERICAN SHOWER DOOR customizes to fit your needs.



## American Shower Door

6920 E. Slauson Avenue / City of Commerce, CA 90040 / 800-421-2333

### STAINLESS STEEL SPECIFICATIONS

**Glass:** 1/4” tempered. All glazing material shall meet or exceed ANSI Z97.1-2004 and CPSC Standard 16 CFR 1201 Category I and II.

**Metal Fabrication:** Formed 304 stainless steel

**Hardware:** Polished or brushed stainless steel handles, stainless steel hinge and rustproof stainless steel screws

**Finishes:** Brushed or polished stainless steel

LINE DRILLING  
ADDS STRENGTH AND BEAUTY  
TO YOUR STAINLESS STEEL JAMBS.  
SCREWS ARE NOT VISIBLE  
ON FRONT OR BACK OF DOOR.

A CONTINUOUS MAGNET  
CLOSES THE DOOR SECURELY. ▼

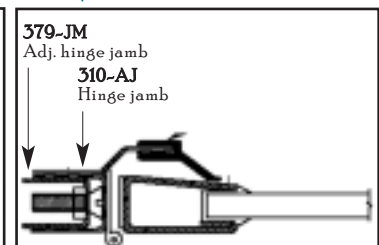
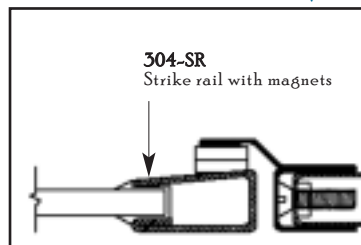

# ◆ SPECIALTY ITEMS ◆

## Curved Glass

Curved glass adds the ultimate elegant touch to a bathing area. Choosing between a framed or heavy glass frameless unit, we will work with you to create and execute the ultimate design.



*Curved panels create beautiful space.*



▲ *Yes, it is a wood overlay on a shower door. Black powder coated metal is used on the interior of the unit for durability in the shower.*

## Splash Panels

Often called a water barrier or splash panel, this popular concept is a simple fixed or operable system. The 3/8" or 1/2" glass panels extend only part-way across the opening – leaving open access for entering the tub or shower.



## ADA Shower Doors

Many of our products can be adapted to meet ADA specifications for handicapped accessibility. Specific doors, such as our 355 rail framed doors, have wider rails, allowing for a taller door with a wider than standard opening. Barrier free requirements will be addressed as requested to assure you a well designed, leakproof system, with no obstructions on the floor. Call for more information on the specific design you have in mind.

# ◆ SPECIFICATION GUIDE ◆

AMERICAN SHOWER DOOR is committed to providing you with the finest in custom shower door products. The following is intended as Product Guidelines – custom design, finish and dimensions are always available.

Doors

DOOR DESCRIPTION	PAGE NO.	MODEL	SUGGESTED MAXIMUM DIMENSIONS	STANDARD FINISHES <small>Optional Std. or Custom Finishes</small>	SUGGESTED APPLICATIONS
<b>FRAMELESS-ALUMINUM FOR 3/16" OR 1/4" GLASS</b>					
PIANO HINGE	13	ELITE 502	35 1/2 x 84	SS-BS-BB-TB-BR'D-PC-SN	Maximum stability in frameless shower-0 to 1" adj. available*
<b>FRAMED-ALUMINUM FOR 3/16" OR 1/4" GLASS</b>					
PIVOT-200 RAIL	13	LIMITED 202	37 x 74	SS-BS-BB-TB-BR'D-PC	Slim profile with framed pivot-0 to 1" adj. available*
PIVOT-200 RAIL	13	MAGNUM 212	37 x 69 5/16	SS-BS-BB-TB-BR'D-PC	Maximum 2" adj. for heavy duty
PIVOT-355 RAIL	13	ATLAS 353	43 1/4 x 69 5/16	SS-BS-BB-PC	Commercial modular design meets 36 barrier free requirement-1 3/4" adj.
PIANO HINGE-200 RAIL (REGULAR OR STEAM)	13	CLASSIC 220	36 x 84	SS-BS-BB-TB-BR'D-PC-SN	A beautiful classic-0 to 1" adj. available*
PIANO HINGE-355 RAIL (REGULAR OR STEAM)	13	MAX 355	36 x 96	SS-BS-BB-BR'D-PC-SN	Custom with wider rail, larger corners-0 to 1" adj. available
DOUBLE PIANO HINGE (REGULAR OR STEAM)	13	SMITHSONIAN 440	60 x 84	SS-BS-BB-TB-BR'D-PC-SN	Double cafe doors with 60" or custom opening
<b>CRYSTAL COLLECTION WITH 3/8", 1/2" OR 3/4" GLASS</b>					
HINGED OR PIVOT (REGULAR OR STEAM)	4-5	CRYSTAL 802	Custom Sizes 50 lbs. per hinge	Brass Hardware with Aluminum Channel	Frameless heavy glass-leakproof jambs or wall mount option
HINGED OR PIVOT (REGULAR OR STEAM)	4-5	CRYSTAL 902	Custom Sizes 50 lbs. per hinge	Polished, Plated or PC	Frameless heavy glass-leakproof jambs or wall mount option
<b>SOLID BRASS FOR 3/16" OR 1/4" GLASS</b>					
FRAMELESS PIANO HINGE	9	VINTAGE 402	Custom Sizes	Polished, Plated or PC	Elegant solid brass piano hinge using frameless 1/4" glass-0 to 1/2" adj.*
FRAMED PIANO HINGE (REGULAR OR STEAM)	9	VINTAGE 455	Custom Sizes	Polished, Plated or PC	Classic piano hinged for Elite solid brass luxury-0 to 1/2" adj.
<b>STAINLESS STEEL FOR 3/16" OR 1/4" GLASS</b>					
FRAMED PIANO HINGE (REGULAR OR STEAM)	20	STAINLESS 304	36 x 84	Polished or Brushed	100% stainless-the ultimate in strength-0 to 1" adj. available

Enclosures

ENCLOSURE DESCRIPTION	PAGE NO.	MODEL	SUGGESTED MAXIMUM DIMENSIONS	STANDARD FINISHES <small>Optional Std. or Custom Finishes</small>	SUGGESTED APPLICATIONS
<b>FRAMELESS-ALUMINUM FOR 3/16" OR 1/4" GLASS</b>					
TRI-SLIDER WITH 1/4"	18	ELITE 810	72 x 76	BS-BB-SN-PC	15% wider clear opening-through glass TB included
TRI-SLIDER WITH 1/4" WITH PANELS	18	ELITE 2810	Add panels x 76	BS-BB-SN-PC	Add inline or return panel to 810
1/4" FRAMELESS	19	ELITE 806	66 x 76	SS-BS-BB-TB-BR'D-PC-SN	New addition-an elegant frameless with "S" jambs- new header design
1/4" FRAMELESS WITH PANELS	19	ELITE 2806	Add panels x 76	SS-BS-BB-TB-BR'D-PC-SN	Adds panels to the 806
<b>FRAMED-ALUMINUM FOR 3/16" OR 1/4" GLASS</b>					
200 RAIL	19	CLASSIC 253	66 x 76	SS-BS-BB-TB-BR'D-PC-SN	Traditional master T sturdy quality extrusions
200 RAIL WITH PANELS	19	CLASSIC 2253	Add panels x 76	SS-BS-BB-TB-BR'D-PC-SN	Versatile "quick stall" panel system
STANDARD 703 RAIL	19	STARLITE 703	66 x 69 3/4	SS-BS-BB-PC	Secondary, economical tub/shower for multi-unit applications
<b>FRAMED-STEAM-ALUMINUM FOR 3/16" OR 1/4" GLASS</b>					
SLIDER	19	TROPIC 272	60 (plus panels) x 96 with transom	BS-BB-PC	Elegant and unusual-a steam slider
<b>CRYSTAL COLLECTION WITH 3/8" OR 1/2" GLASS</b>					
BI-FOLD	3	CRYSTAL	Custom Sizes	Polished, Plated or PC	3/8" or 1/2" glass option
FRAMELESS ALUMINUM	3	CRYSTAL 853	Custom Sizes	SS-BS-BB-BR'D-PC-SN	Elegant frameless aluminum "Euro" slider for 3/8" or 1/2" glass
WITH PANELS	3	CRYSTAL 2853	Custom Sizes	SS-BS-BB-BR'D-PC-SN	Additional panels for your installation
FRAMELESS BRASS	3	CRYSTAL 953	Custom Sizes	Polished, Plated or PC	Solid Brass-Custom plated-frameless enclosures for 3/8" or 1/2" glass
WITH PANELS	3	CRYSTAL 2953	Custom Sizes	Polished, Plated or PC	Add panels with brass extrusions
TRI-SLIDER WITH 3/8"	18	CRYSTAL 838	84 x 76	BS-BB-SN-PC	15% wider opening with heavy glass beauty - may add panels
<b>SOLID BRASS FOR 3/16" OR 1/4" GLASS</b>					
FRAMELESS	10	VINTAGE 405	Custom Sizes	Polished, Plated or PC	Custom plated brass with 1/4" glass
FRAMED	10	VINTAGE 453	Custom Sizes	Polished, Plated or PC	Elite solid brass framed enclosure



# SPECIFICATION GUIDE

10 28 19/AME  
BuyLine 6154

DAYLITE DESCRIPTION	PAGE NO.	MODEL	SUGGESTED MAXIMUM DIMENSIONS	STANDARD FINISHES <small>Optional Std. or Custom Finishes</small>	SUGGESTED APPLICATIONS
<b>FRAMELESS-ALUMINUM FOR 3/16" OR 1/4" GLASS</b>					
WITH PIANO HINGE DOOR	15	ELITE 5020	84 high	SS-BS-BB-TB-BR'D-PC-SN	Accommodates standard or large frameless doors and panels
<b>FRAMED-ALUMINUM FOR 3/16" OR 1/4" GLASS</b>					
PIVOT DOOR-200 RAIL	14-17	LIMITED 2100	74 high	SS-BS-BB-TB-BR'D-PC	Pivot door with narrow rails enhance our contemporary frameless panels
PIVOT HINGE DOOR-200 RAIL (REGULAR OR STEAM)	14-17	CLASSIC 5100	84 high	SS-BS-BB-TB-BR'D-PC-SN	Classic piano hinged door with frameless panels-our most popular model
PIANO HINGE DOOR-355 RAIL (REGULAR OR STEAM)	14-17	MAX 3100	96 high	SS-BS-BB-BR'D-PC-SN	Maximum strength 355 rail door and frameless panels for larger spaces
DOOR AND PANELS-200 RAIL WITH FRAMED PANELS (REGULAR OR STEAM)	16	CLASSIC 100	84 high	SS-BS-BB-BR'D-PC-SN	Classic door with fully framed panels provide a solid traditional design
<b>CRYSTAL COLLECTION WITH 3/8", 1/2" OR 3/4" GLASS</b>					
HINGED OR PIVOT DOOR (REGULAR OR STEAM)	3-5	CRYSTAL 8000	Custom Sizes 50 lbs. per hinge	Brass Hardware with Aluminum Channel	Heavy frameless glass with brass hardware and aluminum extrusions
HINGED OR PIVOT DOOR (REGULAR OR STEAM)	3-5	CRYSTAL 9000	Custom Sizes 50 lbs. per hinge	Polished, Plated or PC	Heavy frameless glass with brass hardware and aluminum extrusions
<b>SOLID BRASS FRAMELESS FOR 3/16" OR 1/4" GLASS</b>					
PIANO HINGE DOOR- WITH FRAMED PANELS	9-10	VINTAGE 4020	Custom Sizes	Polished, Plated or PC	Brass 1/4" frameless door with fully framed traditional panels
PIANO HINGE DOOR- WITH FRAMELESS PANELS	9-10	VINTAGE 4021	Custom Sizes	Polished, Plated or PC	Brass 1/4" frameless door with contemporary frameless panels
<b>SOLID BRASS FRAMED FOR 3/16" OR 1/4" GLASS</b>					
PIANO HINGE DOOR- WITH FRAMED PANELS (REGULAR OR STEAM)	8-10	VINTAGE 4550	Custom Sizes	Polished, Plated or PC	Solid brass framed door with traditional fully framed panels
PIANO HINGE DOOR- WITH FRAMELESS PANELS (REGULAR OR STEAM)	8-10	VINTAGE 4551	Custom Sizes	Polished, Plated or PC	Framed door with contemporary frameless panels
<b>STAINLESS STEEL FRAMED FOR 3/16" OR 1/4" GLASS</b>					
WITH FRAMELESS PANELS (REGULAR OR STEAM)	20	STAINLESS 3040	84 high	Polished or Brushed	Luxurious 100% stainless-hinged door and custom panels

DayLites

SPECIALTY ITEM	PAGE NO.	MODEL	SUGGESTED MAXIMUM DIMENSIONS	STANDARD FINISHES <small>Optional Std. or Custom Finishes</small>	SUGGESTED APPLICATIONS
BI-FOLD	3	CRYSTAL	Custom Sizes	Polished, Plated or PC	3/8" or 1/2"
SNAP-IN EXTRUSIONS		FB & FC 272	121	SS-BS-BB-PC	Easy to install snap-in for panels
EXTRUSIONS SOLID BRASS	9		Custom Sizes	Polished, Plated or PC	Cut to size and custom plated to spec
ALUMINUM			Stock or KDCTS	SS-BS-BB-TB-BR'D-PC-SN	For stocking or custom jobs
HARDWARE	6	PARTS	Stock	Aluminum, Brass, Crystal	Hinges-Handles-and parts for all

Specialty Items

## Finish Codes and Glass Options

### Aluminum:

SS=Satin Silver; BS=Brite Dip Silver; BB=Brite Dip Brass; TB=Tawny Brass; SN=Satin Nickel Anodized PC=Powder Coat (standard or custom colors available) BR'D=Brushed Brite Dip Silver; Special Anodized Finishes on request.

### Solid Brass:

Polished Brass with or without Clear Coat; Polished Chrome; Brushed Chrome; Polished Nickel; Brushed Nickel; Pewter; Antique Brass; Oil Rubbed Bronze; Copper; Antique Finishes; 24K or 18K Gold; Verde Green; Platinum; All Custom matches available on request.

### Suggested Tempered Glass:

Clear, Obscure, Shower Guard, Bronze, Grey, Reed, Rain, Glue Chip, Low Iron, Antique, Reflective Silk Screen, Etched, Antique, Acid Etch, Pine Vue, V-Grooved, Slump, Curved. Any Glass pattern available on request.

Many patterns available in multiple thicknesses; laminates and specialty treatments always available.

### Panel Systems:

In-Line; 90 Degree; 135 Degree; or Off Angles with or without Buttresses.

### Special Notes:

Custom Engineering and Manufacturing will address any wall, ceiling or panel design. Specialty items using our products can be custom engineered to your needs.

\*For the finest installation, you may order framed doors with your choice of 1 or 2 adjustable jambs, or we may rip jambs for an exact fit. Glass will be cut out of square on frameless units to adapt to existing conditions; metal will be ripped on framed units.



# CREATIVE SINCE 1935



*American*  
SHOWER DOOR

6920 E. Slauson Avenue • City of Commerce, CA 90040  
(323) 726-2478 • (800) 421-2333 • Fax (323) 726-7469  
[www.americanshowerdoor.com](http://www.americanshowerdoor.com) • email: [AMSHDR@aol.com](mailto:AMSHDR@aol.com)