

LOCKERS

Penco's Full Range of Lockers



About Penco

Stack It, Store It, Secure It



The need for storage products is universal and Penco has a broad selection of solutions to fill that need. In doing so, Penco has become one of America's largest and most trusted suppliers of storage and work-area products. With state-of-the-art US manufacturing facilities and QuickShip Distribution Centers strategically located throughout the United States and Canada, Penco is positioned to best serve your needs.

Market sectors served by Penco include educational, healthcare, and government facilities, as well as offices, manufacturing companies, distribution warehouses, retail outlets, sports arenas and community parks.

Shelving and pallet rack products are popular with warehousing and manufacturing applications, ranging from a few units to multi-level and high rise applications.

Lockers are widely used in educational facilities, fitness centers, healthcare, military, emergency response, commercial and industrial locations.

Other products such as storage cabinets, work benches and shop furniture are used wherever material gets shipped, received or stored.



Vanguard™, Guardian™, Medallion™, Invincible II™, Defiant™, Stadium® & Patriot® are Trademarks of Penco Products, Inc.

Penco's 145 Year History

In 1869, a man named L. Lewis Sagendorph fulfilled his ambition to begin his own company that would produce the finest metal products in America. He called his fledgling business the Penn Metal Corporation of Pennsylvania, and began by making steel culvert pipe on Oregon Avenue in South Philadelphia.



Over the years, Penn Metal's product lines broadened to include lockers,

shelving and even aircraft landing mats. A reputation for quality fabrication spread, and the company's influence became nationwide. In the 1950's, the name was shortened to Penco Products and the plant and offices were expanded to a modern facility in Oaks, Pennsylvania, near Valley Forge.

In 2001, the manufacturing facilities were moved from Oaks to a 475,000 square foot manufacturing facility in Hamilton, North Carolina, allowing significant room for expansion. In 2013, the corporate headquarters was moved from Skippack, Pennsylvania to Greenville, North Carolina.



Manufacturing facility in Hamilton, NC



Headquarters in Greenville, NC

Customer Service

Penco's Customer Service staff is a customer friendly, knowledgeable team that is dedicated to excellence in service delivery and communication. The team is based at Penco's Greenville, NC headquarters.

Our goal is to provide professional, courteous, timely and accurate service to every customer in a fair, consistent and accessible manner. Penco's distributor partners and customers are our number one priority and focus.

QuickShip Locker Program

3 Strategic Locations for Locker Shipments



QuickShip Vanguard Lockers.....Page 9
QuickShip Locker Accessories..... Pages 10-11

Penco Products leads the industry with its comprehensive QuickShip program. Penco’s QuickShip Distribution Centers have been strategically located throughout North America to best serve customer needs with prompt delivery of products from the shortest distance possible. Penco’s QuickShip program saves time, delivery cost and energy, thus reducing the impact on our environment.



Consult the QuickShip section of our website, www.pencoproducts.com/quickship, for a listing of which products (including Shelving, Cabinets and Bleachers) are available at each warehouse location.



Americans with Disabilities Act information on page 45.



Environmental information on page 45.



Chart of
24 Designer Colors
See Page 46

Lockers

- Locker Overview.....4
- Vanguard™ Lockers..... 6
- QuickShip Vanguard™ Lockers 9
- QuickShip Locker Accessories 10
- Guardian™ Lockers..... 12
- Invincible II™ Lockers..... 14
- All-Welded Lockers 16
- Angle Iron Lockers 18
- Stadium® Lockers..... 20
- Patriot® Lockers 22
- Locker Accessories..... 30
- Basket Racks/Special Purpose Lockers ... 35
- Locker Specifications (see below)..... 36
- ADA/Environmental 45
- Colors 46
- Locker Installation Photos..... 47

Specifications

- Vanguard™ Lockers..... 36
- Guardian™ Lockers..... 37
- Invincible II™ Lockers..... 38
- All-Welded Lockers 39
- Angle Iron Lockers 40
- Stadium® Lockers..... 41
- Patriot® Lockers 42
- Defiant II™ Single Point Latch 43
- Locker Accessories..... 44

Steel Lockers

Overview

Penco has been building lockers for decades that last for decades and has become a part of the fabric of American life. Look in any school and chances are you'll find Penco's lockers in the athletic department, field house, faculty break room and of course, lining the corridors.

School lockers may be Penco's foundation, but the spectrum of products doesn't end there. Penco has locker solutions for recreation centers, health clubs, hospitals, back office and industry break rooms, while at the same time delivering the widest range of solutions to serve first responders in the military, law enforcement and fire and rescue profession.



For locker specifications, see pages 36 - 44.



Terms Used in This Catalog

KD: Knocked Down, or lockers that are shipped unassembled for assembly and installation at their destination.

GA: Gauge of steel - indicates the thickness. The lower the number the thicker the steel.

LH & RH: Left Hand and Right Hand side of a locker, as seen standing in front of a locker.

Tier: A "level" of a locker defined by the number of doors in a vertical row. This can range from 1 to 9 tiers.

Opening & Frame: Opening is what is behind a door. A frame is the unit that holds the doors. There can be multiple doors per frame.

Double Row: "Back-to-back" lockers.

Double Door Locker: A locker with two full length doors that open in the center.

W, D & H: Width, Depth & Height dimensions (inches).



NOTE: All-Welded, Angle Iron, Stadium and Patriot lockers are not shown above.

Steel Lockers

Construction Variations

Ventilation Options

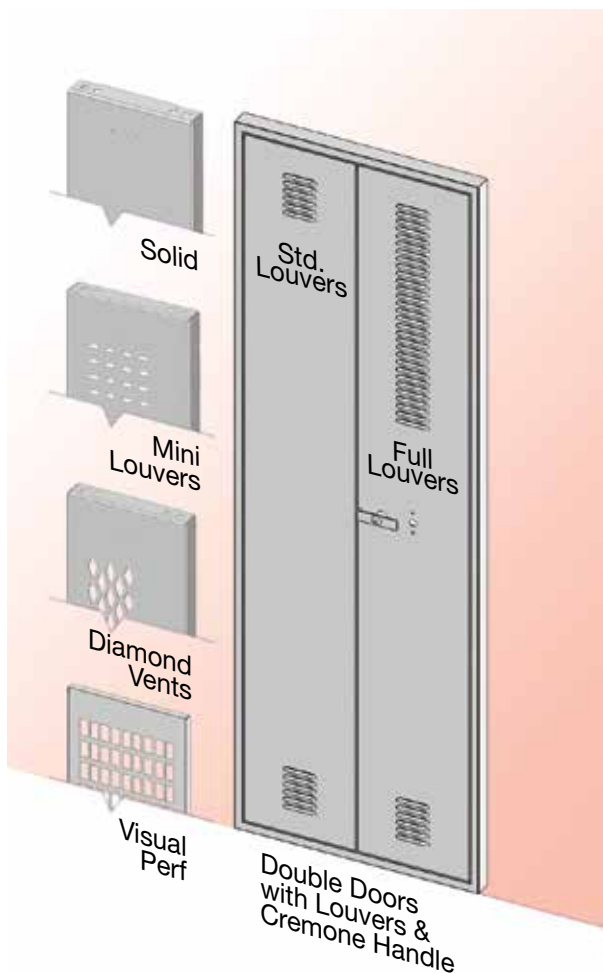

Cremone Multi-Point Handle.



An unbreakable steel handle securely bolted to a 3 point latching system.

A 3/8" diameter latching rod engages at the top and bottom of the door frame. A 1/8" thick center latch locks the center of the door to the frame. The cremone handle is available on a variety of KD and welded heavy duty locker doors; it is standard on Patriot Gear and Duty lockers.

3 views at right: top, middle and bottom of inside of door with cremone handle.

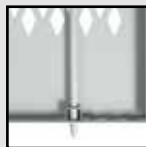

Handles & Latching



Die-Cast Handle. This patented die-cast handle opens multi-point latch lockers with one simple motion. Standard on 1, 2 & 3 tier, 2-Person and Duplex Vanguard lockers.



Automatic Multi-Point Latching. Allows the door to be closed without locking. Standard on all multi-point doors except box lockers, Single Point Latch doors and Cremone Handle lockers.



Classic III Stainless Steel Recessed Handle. Seamless deep drawn design is attractive as well as strong. Utilizes the Automatic Multi-Point Latching feature.



Standard on all 1, 2 & 3 tier 2-Person and Duplex, Vanguard Recessed, Guardian & Guardian PLUS lockers. Also standard on Invincible II and All-Welded 1, 2 and 3 tier lockers. This is the preferred handle for ADA lockers.



Defiant II Single Point Latch. Stainless steel deep drawn pocket with no moving parts (single point latch). Used with a vertical or horizontal pan welded to door. Standard on 1, 2 and 3 tier Defiant II Locker models.



Anti Pry Lug. Defeats prying attempts by capturing the door flange and preventing separation from the door channel.

See Defiant II details on page 43.



Friction Catch Door Pull.

All box lockers come standard with this friction catch door pull handle with padlock hasp.



Spring Loaded Positive Latch. This latch, also known as a "Slam Latch", is available as an option on heavy duty box lockers.

Vanguard™ Steel Lockers

At a Glance

- Knock Down Construction
- Standard louvers for ventilation
- Classic III handle standard on QuickShip multi-point latch models
- 24 ga. body painted to match door frame
- Many sizes available through QuickShip

Ventilation Options



Standard Louvers (S) Full Louvers (O) Mini Louvers (O)

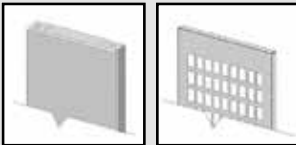

Solid Door (O) Visual Perf (O)

Door Handle Options

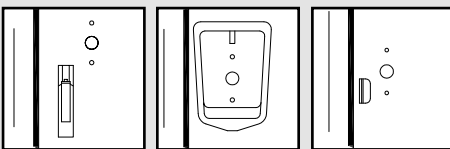

Die-Cast (S) Classic III Recessed (O) Friction Catch (SB)

S = Standard
O = Optional
SB = Standard on Box Lockers



For Vanguard specifications, see page 36.



Penco has been manufacturing lockers for decades that last for decades, and the Vanguard line is the embodiment of what it takes to withstand the daily use and abuse typically dealt to a locker.

The powder coat baked enamel finish is tough and available in all standard colors. Body parts are finished the same color as the doors, as standard. For quieter operation, each latch hook features a noise reducing rubber bumper.

The welded door frames have mortise and tenon construction and are spot welded for lifetime rigidity. Every door has a continuous door strike. All hinges are full loop, 5-knuckle design.

Note that different types of handles are available on many Vanguard lockers and that 3-tier Vanguard lockers have 3 handle choices.

Additional specialty Vanguard models are shown on page 8. Also, many popular Vanguard lockers are available in our QuickShip program with a limited color selection, as shown on pages 9 through 11.

With Classic III Recessed Pocket Handles



1 Tier 2 Tier 3 Tier 2 Person Duplex

All are Available
in 24 Colors
See Page 46



With Vanguard Cast Pull-out Handles



1 Tier 2 Tier 3 Tier 2 Person Duplex

With Box Locker Friction Catch Door Pull Handles



3 Tier 4 Tier 5 Tier 6 Tier

Vanguard™

Sizes and Dimensions

Vanguard 1, 2 & 3 Tier Lockers															
		1 Tier				2 Tier						3 Tier			
Overall Height*		60"	72"	60"	72"	60"	72"	84"	60"	72"	84"	60"	72"	60"	72"
Opening Height*		60"	72"	60"	72"	30"	36"	42"	30"	36"	42"	20"	24"	20"	24"
Width	Depth	Die-Cast Handle		Classic III Handle		Die-Cast Handle			Classic III Handle			Die-Cast Handle		Classic III Handle	
9"	12"	6101V	6151V	6101R	6151R	6201V	6221V	-	6201R	6221R	-	-	-	6401R	6413R
	15"	6103V	6153V	6103R	6153R	6203V	6223V	-	6203R	6223R	-	-	-	6403R	6415R
	18"	6105V	6155V	6105R	6155R	6205V	6225V	-	6205R	6225R	-	-	-	6405R	6417R
12"	12"	6111V	6161V	6111R	6161R	6211V	6231V	6251V	6211R	6231R	6251R	6407V	6419V	6407R	6419R
	15"	6113V	6163V	6113R	6163R	6213V	6233V	6253V	6213R	6233R	6253R	6409V	6421V	6409R	6421R
	18"	6115V	6165V	6115R	6165R	6215V	6235V	6255V	6215R	6235R	6255R	6411V	6423V	6411R	6423R
	21"	6117V	6167V	6117R	6167R	6217V	6218V	-	6217R	6218R	-	6449V	-	6449R	6499R
	24"	6118V	6168V	6118R	6168R	6200V	6220V	-	6200R	6220R	-	-	-	-	-
15"	12"	6119V	6179V	6119R	6169R	6227V	6239V	-	6227R	6239R	-	-	6472V	-	6472R
	15"	6121V	6171V	6121R	6171R	6229V	6241V	6261V	6229R	6241R	6261R	-	6494V	-	6494R
	18"	6123V	6173V	6123R	6173R	6237V	6243V	6263V	6237R	6243R	6263R	-	6496V	-	6496R
	21"	6125V	6175V	6125R	6175R	6257V	6245V	-	6257R	6245R	-	-	-	-	-
	24"	6126V	6177V	6126R	6177R	6258V	6246V	-	-	6246R	-	-	-	-	-
18"	15"	6134V	6180V	6134R	6180R	-	6259V	-	-	6259R	-	-	-	-	-
	18"	6131V	6181V	6131R	6181R	-	6247V	-	-	6247R	-	-	-	-	-
	21"	6133V	6183V	6133R	6183R	-	6249V	-	-	6249R	-	-	-	-	-
	24"	6135V	6185V	6135R	6185R	-	6250V	-	-	6250R	-	-	-	-	-
24"	18"	6149V	6196V	6149R	6196R	-	-	-	-	-	-	-	-	-	-
	21"	6158V	6198V	6158R	6198R	-	-	-	-	-	-	-	-	-	-
	24"	6160V	6199V	6160R	6199R	-	6274V	-	-	6274R	-	-	-	-	-

Vanguard 2 Person and Duplex Lockers									
		2 Person				Duplex			
Overall Height*		60"	72"	60"	72"	60"	72"	60"	72"
Unit Width	Unit Depth	Die-Cast Handle		Classic III Handle		Die-Cast Handle		Classic III Handle	
15"	12"	6510V	6500V	6510R	6500R	-	-	-	-
	15"	6506V	6501V	6506R	6501R	6519V	6531V	6519R	6531R
	18"	6437V	6503V	6437R	6503R	6521V	6533V	6521R	6533R
	21"	-	6505V	-	6505R	-	6535V	-	6535R
18"	15"	-	6509V	-	6509R	-	-	-	-
	18"	-	6515V	-	6515R	-	-	-	-
	21"	-	6525V	-	6525R	-	-	-	-

Vanguard Box Lockers - 3, 4, 5 & 6 Tier								
		3 Tier		4 Tier		5 Tier		6 Tier
Overall Ht.*		60"	72"	60"	72"	60"	72"	72"
Opening Ht.*		20"	24"	15"	18"	12"	14-2/5"	12"
Unit Width	Unit Depth	Cat. No.	Cat. No.	Cat. No.	Cat. No.	Cat. No.	Cat. No.	Cat. No.
9"	12"	6301V	6313V	-	-	-	-	-
	15"	6303V	6315V	-	-	-	-	-
	18"	6305V	6317V	-	-	-	-	-
12"	12"	6307V	6319V	6325V	6331V	6343V	6353V	6365V
	15"	6309V	6321V	6327V	6337V	6345V	6355V	6367V
	18"	6311V	6323V	6329V	6339V	6347V	6357V	6369V
	21"	6349V	6399V	6393V	6395V	-	6435V	6371V
15"	12"	-	6372V	-	-	-	-	6363V
	15"	-	6394V	6333V	6431V	6351V	6359V	6373V
	18"	-	6396V	-	6433V	6397V	6361V	6375V
	21"	-	-	-	-	-	-	6377V
18"	18"	-	6335V	-	-	-	-	6379V
	21"	-	-	-	-	-	-	6378V

* All dimensions are in inches. Overall Height is the overall height of the locker frame, NOT including legs. Opening Height is the nominal height of the individual door opening. Opening Height for 2 Person Lockers: for 60" high models, bottom doors are nominal 42" high; for 72" high models, bottom doors are nominal 54" high. Book compartment doors are nominal 9" high each.

Vanguard™ Specialty Lockers

Dual Lockers

A dual locker is a single tier locker with a vertical partition separating the area beneath the shelf into two compartments. It is ideally suited for situations where street clothes and work clothes are to be kept apart. It is generally used with lockers 15" or 18" wide and 18" or 21" deep. Guardian and Invincible II lockers can also be supplied as dual lockers.



16 Person Locker

Accommodates 16 users in only 69" of floor space. Includes a 45" wide coat rod. Ideal for employee lockers. Accepts built-in locks or padlocks. 69"W x 18" D x 72"H. Cat. No. 6579V



Box Over Lockers



Provides a compact independent lockable door above a 60" high standard Vanguard Door. If a shelf is required in the lower compartment, it must be ordered separately.

Box Over Lockers - 72" High

Unit Width	Unit Depth	Cat. No.
12"	12"	6439V
12"	15"	6441V
12"	18"	6443V
15"	15"	6436V
18"	18"	6445V
18"	21"	6447V

The Executive



The Executive is a custom-outfitted 24" wide double door locker which offers such optional personal amenities as multiple storage shelves, lockable inner storage compartment, and combination comb & brush tray with towel bar. Shown here with the available Classic

Wall Mounted Locker with Coat Rod



A practical storage unit where space is at a premium. Four private compartments

with a hanging area for 16 coats. When wall mounted, the floor below is kept clear for easy cleaning (wall anchors are not included). Can also be set on counters or cabinets (without coat rod). 45"W x 18"D x 13-5/8" H. Cat. No. 68242

7 and 8 Person Lockers



These efficient lockers are ideal for multiple user situations such as school gymnasium locker rooms. The box compartments (18"W x 12"H) are for permanent storage of athletic gear. When a user is present, the large locker (18"W x 60"H) is used for street clothes.

7 Person Locker

Unit Width	Unit Depth	Unit Height	Cat. No.
36"	18"	72"	6573V
36"	21"	72"	6575V

8 Person Locker

Unit Width	Unit Depth	Unit Height	Cat. No.
54"	18"	72"	6577V

III stainless steel recessed handle and optional front and end bases. Note that the depth of shelves and partitions are 3" less than the locker depth.

It is especially appropriate for golf clubs. Other accessories available include golf ball tray, acrylic mirror and name card holder. For ordering information contact your Penco representative.

- Optional Accessories -



Comb & Brush Tray with Towel Bar



Card Holder



Inner storage compartment and golf ball tray

One High Box Locker



This 12" wide individual one high box locker provides storage for personal items and features standard box locker construction with friction catch door pull. Actual overall height is 13-5/8".

Half Height Locker, 1 Tier





Available in 30-1/2", 36-1/2" and 48-1/2" heights; Available in 12", 15" and 18" depths; 12" wide. Only 48-1/2" high lockers include a shelf for storage of books and small articles.



For lead times and
warehouse locations, go to:
pencoproducts.com/lead-times
pencoproducts.com/quickship

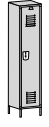
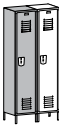

Vanguard™

QuickShip Lockers



QuickShip Vanguard 1 Tier						
Grp.	Illustration	Width	Depth	Opn.Ht.*	028 Gray	073 Champagne
1-Wide		12" 12"	60"	68001R028	68001R073	
		12" 15"	60"	68011R028	68011R073	
		12" 18"	60"	68021R028	68021R073	
		12" 12"	72"	68051R028	68051R073	
		12" 15"	72"	68061R028	68061R073	
		12" 18"	72"	68071R028	68071R073	
		15" 18"	72"	68091R028	68091R073	
		18" 18"	72"	68101R028	68101R073	
2-Wide		12" 12"	60"	68002R028	68002R073	
		12" 15"	60"	68012R028	68012R073	
		12" 18"	60"	68022R028	68022R073	
		12" 12"	72"	68052R028	68052R073	
		12" 15"	72"	68062R028	68062R073	
		12" 18"	72"	68072R028	68072R073	
		15" 18"	72"	68092R028	68092R073	
		18" 18"	72"	68102R028	68103R073	
3-Wide		12" 12"	60"	68003R028	68003R073	
		12" 15"	60"	68013R028	68013R073	
		12" 18"	60"	68023R028	68023R073	
		12" 12"	72"	68053R028	68053R073	
		12" 15"	72"	68063R028	68063R073	
		12" 18"	72"	68073R028	68073R073	
		15" 18"	72"	68093R028	68093R073	
		18" 18"	72"	68103R028	68103R073	



QuickShip Vanguard 2 Tier						
Grp.	Illustration	Width	Depth	Opn.Ht.*	028 Gray	073 Champagne
1-Wide		12" 12"	30"	68111R028	68111R073	
		12" 12"	36"	68121R028	68121R073	
		12" 15"	36"	68131R028	68131R073	
		12" 18"	36"	68141R028	68141R073	
		15" 18"	36"	68261R028	68261R073	
2-Wide		12" 12"	30"	68112R028	68112R073	
		12" 12"	36"	68122R028	68122R073	
		12" 15"	36"	68132R028	68132R073	
		12" 18"	36"	68142R028	68142R073	
		15" 18"	36"	68262R028	68262R073	
3-Wide		12" 12"	30"	68113R028	68113R073	
		12" 12"	36"	68123R028	68123R073	
		12" 15"	36"	68133R028	68133R073	
		12" 18"	36"	68143R028	68143R073	
		15" 18"	36"	68263R028	68263R073	



QuickShip Vanguard 3 Tier						
Grp.	Illustration	Width	Depth	Opn.Ht.*	028 Gray	073 Champagne
1-Wide		12" 12"	24"	68331R028	68331R073	
		12" 15"	24"	68341R028	68341R073	
		12" 18"	24"	68351R028	68351R073	
2-Wide		12" 12"	24"	68332R028	68332R073	
		12" 15"	24"	68342R028	68342R073	
		12" 18"	24"	68352R028	68352R073	
3-Wide		12" 12"	24"	68333R028	68333R073	
		12" 15"	24"	68343R028	68343R073	
		12" 18"	24"	68353R028	68353R073	

For lockers in a hurry!

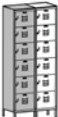
- KD lockers ship in 72 hours
- Many QuickShip accessories are available (see next pages)
- 1, 2 & 3 Tier Models have Recessed Handles
- Assembly available by request
- 6" Legs standard (available with no legs by request)
- Number plates included
- 1, 2 and 3-Wide groupings

QuickShip Vanguard 5 Tier						
Grp.	Illustration	Width	Depth	Opn.Ht.*	028 Gray	073 Champagne
1-Wide		12" 12"	12"	12"	68161X028	68161X073
		12" 15"	12"	12"	68171X028	68171X073
2-Wide		12" 12"	12"	12"	68162X028	68162X073
		12" 15"	12"	12"	68172X028	68172X073
3-Wide		12" 12"	12"	12"	68163X028	68163X073
		12" 15"	12"	12"	68173X028	68173X073

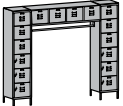
QuickShip Vanguard 6 Tier						
Grp.	Illustration	Width	Depth	Opn.Ht.*	028 Gray	073 Champagne
1-Wide		12" 12"	12"	12"	68191X028	68191X073
		12" 15"	12"	12"	68201X028	68201X073
		12" 18"	12"	12"	68211X028	68211X073
2-Wide		12" 12"	12"	12"	68192X028	68192X073
		12" 15"	12"	12"	68202X028	68202X073
		12" 18"	12"	12"	68212X028	68212X073
3-Wide		12" 12"	12"	12"	68193X028	68193X073
		12" 15"	12"	12"	68203X028	68203X073
		12" 18"	12"	12"	68213X028	68213X073

QuickShip Vanguard Specialty Lockers						
16 Person						
Illustration	Width	Depth	Frame Ht.*	028 Gray	073 Champagne	
	69"	18"	72"	68231X028	68231X073	
Wall Mount						
	45"	18"	13-5/8"	68242X028	68242X073	

* Height shown is the nominal opening height for 1 through 6 tier, and overall frame height for others, not including 6" legs which are standard on all except the Wall Mount Locker. Width is the nominal outside dimension for 1 frame.

** Shaded area in illustrations indicates the unit of sale; i.e. Cat. No. 68003R028 is for one frame of a 12" x 12" x 60" 1 tier locker, but since it is packaged in a group of 3, it must be ordered in multiples of 3.



QuickShip Slope Top Kits

1- Wide

Width	Depth	Height	028 Gray	073 Champagne
12"	12"	4"	60229H028	60229H073
12"	15"	5"	60231H028	60231H073
12"	18"	6"	60233H028	60233H073
15"	18"	6"	60239H028	60239H073
18"	18"	6"	60243H028	60243H073



3-Wide

Width	Depth	Height	028 Gray	073 Champagne
12"	12"	4"	60230H028	60230H073
12"	15"	5"	60232H028	60232H073
12"	18"	6"	60234H028	60234H073
15"	18"	6"	60240H028	60240H073
18"	18"	6"	60244H028	60244H073

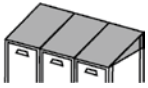

3-Wide
Slope Top Kit



QuickShip Locker Bases, 6" High (for lockers with 6" Legs)

Front Bases

Width	Depth	Height	028 Gray	073 Champagne
12"	-	6"	60217-028	60217-073
15"	-	6"	60218-028	60218-073
18"	-	6"	60219-028	60219-073

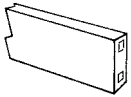

End Bases

Width	Depth	Height	028 Gray	073 Champagne
-	12"	6"	60204-028	60204-073
-	15"	6"	60205-028	60205-073
-	18"	6"	60206-028	60206-073

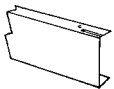

QuickShip Fillers

Vertical Angles

Width	Depth	Height	028 Gray	073 Champagne
12"	-	60"	66113-028	66113-073
12"	-	66"	661221-028	661221-073
12"	-	72"	661141-028	661141-073
12"	-	78"	66116-028	66116-073

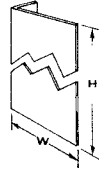

Wall Angles (Slip Joint)

Width	Depth	Height	028 Gray	073 Champagne
-	-	60"	66118-028	66118-073
-	-	66"	66120-028	66120-073
-	-	72"	66119-028	66119-073
-	-	78"	66121-028	66121-073



Flat Top Fillers (Overlaps Standard Tops)

Width	Depth	Height	028 Gray	073 Champagne
15"	12"	-	661321C028	661321C073
15"	15"	-	661322C028	661322C073
15"	18"	-	661323C028	661323C073

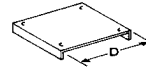

Flat Top Corner Fillers

Width	Depth	Height	028 Gray	073 Champagne
12"	12"	-	66138-028	66138-073
15"	15"	-	66139-028	66139-073
18"	18"	-	66140-028	66140-073

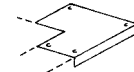

Slope Top Fillers

Width	Depth	Height	028 Gray	073 Champagne
15"	12"	-	661371-028	661371-073
15"	15"	-	661372-028	661372-073
15"	18"	-	661373-028	661373-073

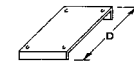

Slope Top Corner Fillers

Width	Depth	Height	028 Gray	073 Champagne
12"	12"	-	66100-028	66100-073
15"	15"	-	66101-028	66101-073
18"	18"	-	66102-028	66102-073

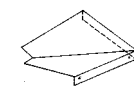

QuickShip Zee Bases (949 Black) For Lockers without Legs

Width	Depth	Height	Cat. No.
Front Zee Base (14 Ga.)			
72"	-	4"	66700H949
Splice/End Base			
-	12"	4"	66701H949
-	15"	4"	66702H949
-	18"	4"	66703H949
Zee Inside Corner Splice			
-	-	4"	66709H949
Rear Leg (for use with 4" H Zee)			
-	-	13"	60092-949

See
illustration
at right

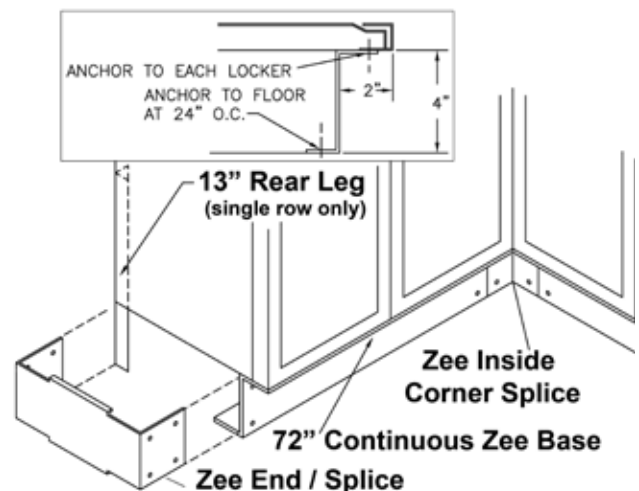

For lead times and warehouse locations, go to:
pencoproducts.com/lead-times
pencoproducts.com/quickship

Vanguard™

QuickShip Locker Accessories

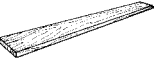
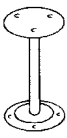
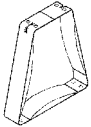
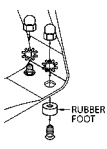
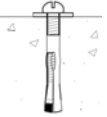

QuickShip Locker Room Benches & Accessories

	Width	Depth	Height	Cat. No.	Description
Wood Bench Tops					
	36"	9-1/2"	1-1/4"	9611	Finished with clear lacquer. Use 2 pedestals per bench through 96".
	48"	9-1/2"	1-1/4"	9600	
	72"	9-1/2"	1-1/4"	9602	
	96"	9-1/2"	1-1/4"	9604	
Steel Tube Heavy Duty Pedestals					
	028 Gray		16-1/4"	60822H028	Includes hardware to mount to bench. Pedestal must be anchored to floor for safety - see concrete floor anchor.
	073 Champagne		16-1/4"	60822H073	
Stainless Steel Pedestal					
	-		16-1/4"	60827H	Includes hardware to fasten to bench. See non-skid kit below.
Non-Skid Pedestal Kit for Stainless Pedestal					
	-	-	-	68420	Set of 4 rubber feet and hardware for Stainless Steel Pedestals. Order 1 set per pedestal.
Concrete Floor Anchor 1/4" Diameter					
	-		2"	9680	





Wood Bench with Steel Tube Pedestals



Wood Bench with Stainless Steel Pedestals

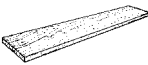

ADA Benches/Bracket/Shelves/Logo

Benches for ADA Applications					
	48"	18"	1-1/4"	9628	These benches are used with the Bench Bracket (below).
	48"	24"	1-1/4"	9623	
Bench Bracket for ADA Bench - 073 Champagne					
	-	20"	20"	6ACXHP61H073	To provide back support with 18" bench and 24" seat.
ADA Logo Label					
	-	-	-	8690	
Locker Shelves for ADA Applications					
	Width	Depth	Height	028 Gray	073 Champagne
	12"	12"	-	60400-028	60400-073
	12"	15"	-	60402-028	60402-073
	12"	18"	-	60404-028	60404-073
	15"	18"	-	60408-028	60408-073
	18"	18"	-	60412-028	60412-073

Extra shelves must be installed in the field - may require drilling.

QuickShip Locks

	Description	Cat. No.
Key Locks, Built-In		
	Dead Bolt, Flat Key Lock	9617
	Master Key for Dead Bolt Flat Key Lock	96171



Dead Bolt, Flat Key Lock

GUARDIAN™

Steel Lockers

At a Glance

- Knock Down Construction
- Standard solid 16 ga. door and Classic III handle
- 14 ga. door available
- Optional Defiant II single point latching

Ventilation Options



Solid Door (S)



Standard Louvers (O)



Full Louvers (O)



Mini Louvers (O)



Diamond Shaped (A)

Door Options



Medallion (O)



Guardian PLUS (A)



Guardian Defiant II (A)

Door Handle Options

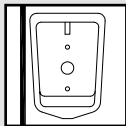

Classic III Recessed (S)

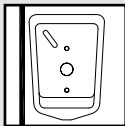

Defiant II Recessed (A)

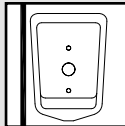

Defiant II Rotary Recessed (A)

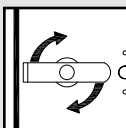

Cremone Turn Handle (A - On most Guardian "Plus" models)

S = Standard
O = Optional
A = Available with 14 gauge door only



For Guardian specifications, see page 37.
For Defiant Doors, see page 43.



Standard Guardian lockers build upon the design features of the Vanguard series with several enhancements and options that give it a distinctive look.

Our one piece deep drawn Classic III stainless steel recessed handle is part of every Guardian. It eliminates protrusions from the locker front and accepts a padlock or a built-in lock.

The 16 gauge door front has a solid exterior, aiding quiet operation. Ventilation is achieved by slots in the top and bottom flanges of the door.

Medallion Option: This upgrade has a sound damping panel welded to the door reducing noise levels when doors are slammed.

Guardian PLUS: This upgrade increases the thickness of the door to 14 gauge. The Guardian PLUS locker is ideally suited for corridors and situations where the locker is likely to encounter harsher than normal usage.

Guardian Defiant II: This combines a 14 gauge door with a single point latch stainless steel pocket and a reinforcing pan that stiffens the door. See page 43 for more information.



1 Tier



2 Tier



3 Tier



2 Person



Duplex

Sizes and Dimensions

Guardian 1 Tier Lockers									
		Standard Door 16 ga.*		Medallion Door 16 ga.*		Guardian PLUS 14 ga.		Defiant II Latch- 14 ga.	
Opening Height		60"	72"	60"	72"	60"	72"	60"	72"
Width	Depth	Cat. No.	Cat. No.	Cat. No.	Cat. No.	Cat. No.	Cat. No.	Cat. No.	Cat. No.
9"	12"	6101G	6151G	6101M	6151M	6C101	6C151	-	-
	15"	6103G	6153G	6103M	6153M	6C103	6C153	-	-
	18"	6105G	6155G	6105M	6155M	6C105	6C155	-	-
12"	12"	6111G	6161G	6111M	6161M	6C111	6C161	6E111	6E161
	15"	6113G	6163G	6113M	6163M	6C113	6C163	6E113	6E163
	18"	6115G	6165G	6115M	6165M	6C115	6C165	6E115	6E165
	21"	6117G	6167G	6117M	6167M	6C117	6C167	6E117	6E167
	24"	6144G	6168G	-	6168M	6C144	6C168	-	-
15"	12"	6119G	6169G	6119M	6169M	6C119	6C169	6E119	6E169
	15"	6121G	6171G	6121M	6171M	6C121	6C171	6E121	6E171
	18"	6123G	6173G	6123M	6173M	6C123	6C173	6E123	6E173
	21"	6125G	6175G	6125M	6175M	6C125	6C175	6E125	6E175
18"	18"	6131G	6181G	-	6181M	6C131	6C181	6E131	6E181
	21"	6133G	6183G	-	6183M	6C133	6C183	6E133	6E183
	24"	6135G	6185G	-	6185M	6C135	6C185	6E135	6E185

Guardian 2 Tier Lockers									
		Standard Door 16 ga.*		Medallion Door 16 ga.*		Guardian PLUS 14 ga.		Defiant II Latch - 14 ga.	
Overall Height		60"	72"	60"	72"	60"	72"	60"	72"
Opening Height		30"	36"	30"	36"	30"	36"	30"	36"
Width	Depth	Cat. No.	Cat. No.	Cat. No.	Cat. No.	Cat. No.	Cat. No.	Cat. No.	Cat. No.
12"	12"	6211G	6231G	6211M	6231M	6C211	6C231	6E211	6E231
	15"	6213G	6233G	6213M	6233M	6C213	6C233	6E213	6E233
	18"	6215G	6235G	6215M	6235M	6C215	6C235	6E215	6E235
	21"	6217G	6218G	6217M	6218M	6C217	6C218	6E217	6E218
	24"	-	6220G	-	6220M	-	-	-	6E220
15"	12"	6227G	6239G	-	6239M	6C227	6C239	6E227	6E239
	15"	6229G	6241G	-	6241M	6C229	6C241	6E229	6E241
	18"	6237G	6243G	-	6243M	6C237	6C243	6E237	6E243
	21"	6257G	6245G	-	6245M	6C257	6C245	6E257	6E245
	24"	-	6246G	-	6246M	-	-	-	-
18"	18"	-	6247G	-	-	-	6C247	6E281	6E247
	21"	-	6249G	-	-	-	6C249	6E283	6E249

Guardian 3 Tier Lockers								
		Standard 16 ga.		Medallion 16 ga.	Guardian PLUS 14 ga.		Defiant II Latch 14 ga.	
Overall Height		60"	72"	72"	60"	72"	60"	72"
Opening Height		20"	24"	24"	20"	24"	20"	24"
Width	Depth	Cat. No.	Cat. No.	Cat. No.	Cat. No.	Cat. No.	Cat. No.	Cat. No.
12"	12"	6407G	6419G	6419M	6C407	6C419	6E407	6E419
	15"	6409G	6421G	6421M	6C409	6C421	6E409	6E421
	18"	6411G	6423G	6423M	6C411	6C423	6E411	6E423
	21"	6449G	6499G	6499M	6C449	6C499	6E449	6E499
15"	12"	-	6425G	-	-	6C425	-	6E425
	15"	6451G	6427G	-	-	6C427	6E451	6E427
	18"	6453G	6429G	-	-	6C429	6E453	6E429
	21"	6455G	6437G	-	-	6C437	6E455	6E437

Guardian 2 Person Lockers			
		Standard 16 ga.	Medallion 16 ga.
Overall Height		72"	72"
Opening Height		52"	52"
Width	Depth	Cat. No.	Cat. No.
15"	15"	6501G	6501M
	18"	6503G	6503M

Guardian Duplex Lockers			
		Standard 16 ga.	
Opening Height		72"	
Width	Depth	Cat. No.	
15"	15"	6531G	
	18"	6533G	

* Standard Guardian & Medallion Option doors less than 12" wide are 18 gauge.

NOTE: 1, 2 & 3 Tier, 2 Person and Duplex lockers are ordered by the FRAME. Overall heights do NOT include legs.

Invincible II™

Steel Lockers

At a Glance

- Knock Down Construction
- Diamond perforations on door and sides
- 14 ga. door, 16 ga. body & 18 ga. back
- Classic III or Defiant II handle available on 1, 2 and 3 tier
- Friction or spring latch on 4 through 9 tier

Ventilation Options



Diamond Shaped (S)



Standard Louvers (O)



Full Louvers (O)



Mini Louvers (O)



Solid Door (O)

Door Handle Options

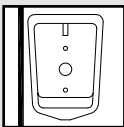

Classic III Recessed (S)

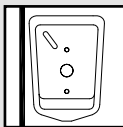

Defiant II Recessed (O)

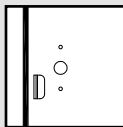

Friction Catch (SB)

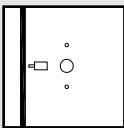

Slam Latch (OB)

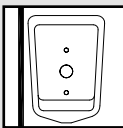

Defiant II Rotary Recessed (A)

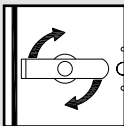

Cremone Turn Handle
(A - On most 1, 2 and 3 Tier models)

- A = Available
- S = Standard
- O = Optional
- SB = Std. on Box Lockers
- OB = Optional on Box Lockers

For Invincible II specifications, see page 38.
For Defiant Doors, see page 43.



Penco's Invincible II athletic lockers are an exceptionally attractive and durable choice for gym lockers. Ideal for applications that require a high degree of ventilation and strength, or where visual inspection of locker contents is desired.

Doors are made from heavy 14 gauge steel. Sides, tops, bottoms and shelves are 16 gauge steel. Backs are 18 gauge. Doors and sides are perforated with a diamond-shaped pattern allowing maximum air circulation while maintaining security. Solid doors are an option.

Invincible II lockers come in a variety of styles: 1 tier, 2 tier and 3 tier all have as standard the Classic III stainless steel recessed handle and multi-point latching. Standard 4, 5, 6, 8 and 9 tier box lockers doors have a padlock hasp and a friction catch, and will accept built-in locks. Available at extra cost is a spring-loaded catch.

Both 2 & 3 tier lockers have horizontal frame members welded between the doors for added strength and security. 24" wide lockers have full width doors. If slope tops are required, use hoods. All lockers accept built-in locks or padlocks and have rubber bumpers on the latch hooks to reduce noise.



1 Tier

2 Tier

3 Tier

4 Tier

5 Tier

6 Tier

8 Tier

9 Tier

Invincible II™

Sizes and Dimensions

Invincible II 1 Tier Lockers					
		Std. Cat. No.		Defiant II	
Overall Ht.		-	-	-	-
Opening Ht.		60"	72"	60"	72"
Width	Depth	Cat. No.	Cat. No.	Cat. No.	Cat. No.
9"	12"	6A101	6A107	-	-
	15"	6A103	6A109	-	-
	18"	6A105	6A111	-	-
12"	12"	6A129	6A157	6P129	6P157
	15"	6A131	6A159	6P131	6P159
	18"	6A135	6A161	6P135	6P161
	21"	6A133	6A163	-	-
15"	15"	6A143	6A169	6P143	6P169
	18"	6A145	6A171	6P145	6P171
	21"	6A147	6A173	6P147	6P173
	24"	-	6A172	-	-
18"	15"	6A149	6A175	6P149	6P175
	18"	6A151	6A177	6P151	6P177
	21"	6A153	6A179	6P153	6P179
	24"	6A155	6A181	6P155	6P181
24"	15"	-	6A182	-	-
	18"	6A117	6A123	6P117	6P123
	21"	6A119	6A125	6P119	6P125
	24"	6A121	6A127	6P121	6P127

Invincible II 2 Tier Lockers					
		Std. Cat. No.		Defiant II	
Overall Ht.		60"	72"	60"	72"
Opening Ht.		30"	36"	30"	36"
Width	Depth	Cat. No.	Cat. No.	Cat. No.	Cat. No.
9"	12"	-	-	-	-
	15"	-	-	-	-
	18"	-	-	-	-
12"	12"	6A213	6A245	6P213	6P245
	15"	6A215	6A247	6P215	6P247
	18"	6A217	6A249	6P217	6P249
	21"	-	6A251	-	-
15"	15"	6A225	6A257	6P225	6P257
	18"	6A239	6A259	6P239	6P259
	21"	6A241	6A261	6P241	6P261
	24"	-	6A253	-	-
18"	15"	6A223	6A263	6P223	6P263
	18"	6A227	6A265	6P227	6P265
	21"	6A229	6A267	6P229	6P267
	24"	6A231	6A269	6P231	6P269
24"	15"	-	-	-	-
	18"	6A233	6A271	6P233	6P271
	21"	6A235	6A273	6P235	6P273
	24"	6A237	6A275	6P237	6P275

Invincible II 3 Tier Lockers					
		Std. Cat. No.		Defiant II	
Overall Ht.		60"	72"	60"	72"
Opening Ht.		20"	24"	20"	24"
Width	Depth	Cat. No.	Cat. No.	Cat. No.	Cat. No.
9"	12"	-	-	-	-
	15"	-	-	-	-
	18"	-	-	-	-
12"	12"	6A287	6A281	6P287	6P281
	15"	6A289	6A283	6P289	6P283
	18"	6A291	6A285	6P291	6P285
	21"	-	-	-	-
15"	15"	6A293	6A301	6P293	6P301
	18"	6A295	6A303	6P295	6P303
	21"	6A297	6A305	6P297	6P305
	24"	-	-	-	-
18"	15"	-	-	-	-
	18"	6A220	6A221	-	-
	21"	-	-	-	-
	24"	-	-	-	-
24"	15"	-	-	-	-
	18"	-	-	-	-
	21"	-	-	-	-
	24"	-	-	-	-

Invincible II 4, 5, 6, 8 & 9 Tier Box Lockers								
		4 Tier		5 Tier		6 Tier	8 Tier	9 Tier
Overall Height		60"	72"	60"	72"	72"	72"	72"
Opening Height		15"	18"	12"	14-2/5"	12"	9"	8"
Width	Depth	Cat. No.	Cat. No.	Cat. No.	Cat. No.	Cat. No.	Cat. No.	Cat. No.
12"	12"	6A307	6A319	6A351	6A363	6A375	6A393	6A407
	15"	6A309	6A321	6A353	6A365	6A377	6A395	6A409
	18"	6A311	6A323	6A355	6A367	6A379	6A397	6A411
	21"	-	-	-	-	6A381	-	-
15"	15"	6A313	6A331	6A357	6A369	6A383	6A401	6A413
	18"	6A315	6A335	6A359	6A371	6A385	6A403	6A415
	21"	-	-	6A361	6A373	6A389	6A405	6A417
18"	18"	-	-	6A419	6A445	6A423	-	-
	21"	-	-	6A421	6A447	6A425	-	-

Group Ends for Invincible II Lockers					
		Perforated Single Row		Solid Single Row	
Height	Depth	1 - 6 Tier Cat. No.	8 & 9 Tier Cat. No.	1 - 6 Tier Cat. No.	8 & 9 Tier Cat. No.
36-1/2"	12"	603600V	-	603601S	-
	15"	603602V	-	603603S	-
	18"	603704V	-	603605S	-
48-1/2"	12"	603606V	-	603607S	-
	15"	603608V	-	603609S	-
	18"	603700V	-	603701S	-
60"	12"	602100V	-	602101S	-
	15"	602102V	-	602103S	-
	18"	602104V	-	602105S	-
	21"	602106V	-	602107S	-
72"	24"	602108V	-	602109S	-
	12"	602110V	602120V	602111S	602121S
	15"	602112V	602122V	602113S	602123S
	18"	602114V	602124V	602115S	602125S
	21"	602116V	602126V	602117S	602127S
24"	602118V	-	602119S	-	

Ordering Group Ends for Invincible II Lockers

You must order a Group End to finish each group of Invincible II lockers, regardless of length of each group or row. Specify Perforated or Solid.

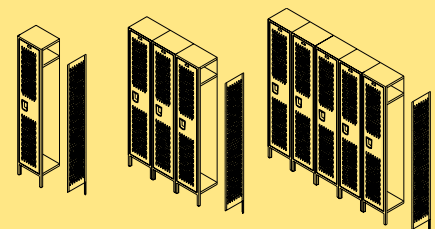

1 Basic Unit
1 Group End

3 Basic Units
1 Group End

5 Basic Units
1 Group End

All-Welded Steel Lockers

At a Glance

- 16 ga. body & 18 ga. back for durability
- 14 ga. door and Classic III handle standard
- Optional Defiant II single point latching
- Ships fully assembled

Ventilation Options



Diamond Shaped (S)



Standard Louvers (O)



Full Louvers (O)



Mini Louvers (O)



Solid Door (O)

Base Options

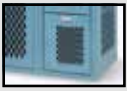

No Legs or Base (S)

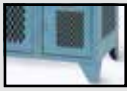

4" Legs (O)



Channel Base (O)

Door Handle Options

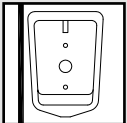

Classic III Recessed (S)

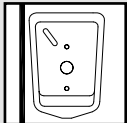

Defiant II Recessed (O)

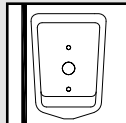

Defiant II Rotary Recessed (O)

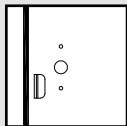

Friction Catch (SB)

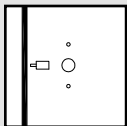

Slam Latch (OB)

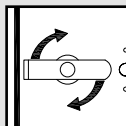

Cremone Turn Handle (A-On most 1, 2 and 3 Tier models)

A = Available

S = Standard

O = Optional

SB = Standard on Box Lockers

OB = Optional on Box Lockers

For All-Welded specifications, see page 39.

For Defiant Doors, see page 43.

The All-Welded Alternative

Penco's All-Welded Lockers give you a choice between our traditional K.D. locker lines, and our All-Welded setup lockers.

All-Welded lockers offer superior resistance to hard use and abuse. All body parts are welded into a single rigid unit to resist damage for the life of the product. The door frame and locker side are 16 gauge. The backs, tops and bottoms of each group of lockers are made from single pieces of steel that span multiple lockers. The doors are made from 14 gauge steel and include a continuous hinge. Sides, tops, bottoms and shelves are 16 gauge steel. Backs are 18 gauge.

Since All-Welded lockers are shipped pre-assembled, the time and expense of on-site installation is greatly

reduced. This is a great help where labor is either extremely expensive, or hard to find. Groupings will be determined by Penco based upon the floor plan layout drawings submitted with the order (not to exceed 54").

All-Welded lockers are available as standard in ventilated models with diamond-shaped perforations in the doors and sides for maximum visibility and ventilation, or with solid door and side construction, with or without door louvers. The perforated models are ideal for heavy duty athletic use, where ventilation is important to aid the drying of athletic gear.

Standard construction is flat top without legs. Lockers can be ordered with 4" high legs or 4" high 16 gauge integral Channel Bases, as options.



1 & 2 Tier

3 & 4 Tier

5 & 6 Tier

8 & 9 Tier

All-Welded

Sizes and Dimensions

All-Welded 1 Tier Lockers					
		Standard Cat. No.		Defiant II Latch	
Opening Height		60"	72"	60"	72"
Unit Width	Unit Depth	Cat. No.	Cat. No.	Cat. No.	Cat. No.
9"	12"	6WP100	6WP120	-	-
	15"	6WP101	6WP121	-	-
	18"	6WP102	6WP122	-	-
12"	12"	6WP103	6WP123	6WD103	6WD123
	15"	6WP104	6WP124	6WD104	6WD124
	18"	6WP105	6WP125	6WD105	6WD125
	21"	6WP106	6WP126	-	-
	24"	6WP107	6WP127	-	-
15"	12"	6WP108	6WP128	-	6WD128
	15"	6WP109	6WP129	6WD109	6WD129
	18"	6WP110	6WP130	6WD110	6WD130
	21"	6WP111	6WP131	6WD111	6WD131
	24"	6WP112	6WP132	-	-
18"	12"	6WP172	6WP182	6WD172	-
	15"	6WP173	6WP183	6WD173	-
	18"	6WP113	6WP133	6WD113	6WD133
	21"	6WP114	6WP134	6WD114	6WD134
	24"	6WP115	6WP135	6WD115	6WD135
24"	18"	6WP116	6WP136	6WD116	6WD136
	21"	6WP117	6WP137	6WD117	6WD137
	24"	6WP118	6WP138	6WD118	6WD138

All-Welded 2 Tier Lockers					
		Standard Cat. No.		Defiant II Latch	
Overall Height		60"	72"	60"	72"
Opening Height		30"	36"	30"	36"
Unit Width	Unit Depth	Cat. No.	Cat. No.	Cat. No.	Cat. No.
12"	12"	6WP203	6WP223	6WD203	6WD223
	15"	6WP204	6WP224	6WD204	6WD224
	18"	6WP205	6WP225	6WD205	6WD225
	21"	6WP206	6WP226	-	-
15"	24"	6WP207	6WP227	-	-
	12"	6WP208	6WP228	6WD208	6WD228
	15"	6WP209	6WP229	6WD209	6WD229
	18"	6WP210	6WP230	6WD210	6WD230
18"	21"	6WP211	6WP231	6WD211	6WD231
	24"	6WP212	6WP232	-	6WD232
	12"	-	6WP282	-	-
	15"	6WP273	6WP283	-	-
24"	18"	6WP213	6WP233	6WD213	6WD233
	21"	6WP214	6WP234	6WD214	6WD234
	24"	6WP215	6WP235	6WD215	6WD235
	18"	6WP216	6WP236	-	-
24"	21"	6WP217	6WP237	-	-
	24"	6WP218	6WP238	-	-

All-Welded 3 Tier Lockers					
		Std. Cat. No.		Defiant II Latch	
Overall Height		60"	72"	60"	72"
Opening Height		20"	24"	20"	24"
Unit Width	Unit Depth	Cat. No.	Cat. No.	Cat. No.	Cat. No.
12"	12"	6WP303	6WP323	6WD303	6WD323
	15"	6WP304	6WP324	6WD304	6WD324
	18"	6WP305	6WP325	6WD305	6WD325
	21"	6W9306	6WP326	-	-
	24"	6WP307	6WP327	-	-
15"	12"	6WP308	6WP328	-	-
	15"	6WP309	6WP329	6WD309	6WD329
	18"	6WP310	6WP330	6WD310	6WD330
	21"	6WP311	6WP331	6WD311	6WD331
18"	24"	6WP312	6WP332	-	-
	12"	-	-	-	-
	15"	-	-	-	-
	18"	6WP313	6WP333	-	6WD333
	21"	6WP314	6WP334	-	6WD334
24"	6WP315	6WP335	-	6WD335	

All-Welded 4, 5, 6, 8 & 9 Tier Box Lockers								
		4 Tier		5 Tier		6 Tier	8 Tier	9 Tier
Overall Ht.		60"	72"	60"	72"	72"	72"	72"
Opening Ht.		15"	18"	12"	14-2/5"	12"	9"	8"
Unit Width	Unit Depth	Cat. No.	Cat. No.	Cat. No.	Cat. No.	Cat. No.	Cat. No.	Cat. No.
12"	12"	6WP403	6WP423	6WP503	6WP523	6WP623	6WP823	6WP923
	15"	6WP404	6WP424	6WP504	6WP524	6WP624	6WP824	6WP924
	18"	6WP405	6WP425	6WP505	6WP525	6WP625	6WP825	6WP925
	21"	6WP406	6WP426	6WP506	6WP526	6WP626	-	-
	24"	6WP407	6WP427	6WP507	6WP527	6WP627	-	-
15"	12"	6WP408	6WP428	6WP508	6WP528	6WP628	6WP828	6WP928
	15"	6WP409	6WP429	6WP509	6WP529	6WP629	6WP829	6WP929
	18"	6WP410	6WP430	6WP510	6WP530	6WP630	6WP830	6WP930
	21"	6WP411	6WP431	6WP511	6WP531	6WP631	-	-
18"	24"	6WP412	6WP432	6WP512	6WP532	6WP632	-	-
	18"	-	-	6WP513	-	6WP633	-	-
	21"	-	-	6WP514	-	6WP634	-	-



Angle Iron Steel Lockers

At a Glance

- Fully welded angle frame construction
- Continuous piano-style hinges standard (or optional 3" butt hinges)
- Diamond, solid or expanded metal sides
- Bottom reinforced with a 16 gauge channel

Ventilation Options



Diamond Shaped (S)



Standard Louvers (O)



Full Louvers (O)



Mini Louvers (O)



Solid Door (O)

Base Options



No Legs or Base (S)

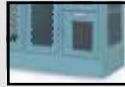

Channel Base (O)

Door Handle Options

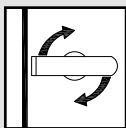

Cremone 3 Point (O)

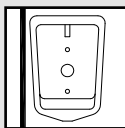

Classic III Recessed (O)

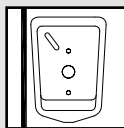

Defiant II Recessed (O)

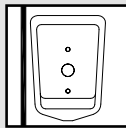

Defiant II Rotary Recessed (O)

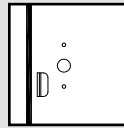

Friction Catch (SB)

S = Standard
O = Optional
SB = Standard on Box Lockers



For Angle Iron specifications, see page 40.
For Defiant Doors, see page 43.

Rugged Welded Angle Iron Framework

The Penco Angle Iron Locker is built within a 1" x 1" x 1/8" angle iron frame. This 1/8" thick angle iron exoskeleton creates extra strong locker edges and provides a solid framework. Diamond perforated doors and sides offer a high degree of air flow.

Lockers are built in groups with the top, bottom and back panels spanning multiple lockers, which reduces seams and adds rigidity.

Options and Accessories:

- Multiple handle/latch types
- Continuous Slope Hoods
- Padlocks and built-in locks
- Optional 4" high 14 gauge welded base
- Optional Expanded Metal Sides

Angle Iron Advantages:

- Excellent for Athletic Applications
- Rugged Welded Angle Iron Framework
- Durable Continuous Hinges or Optional 3" butt Hinges
- Two Multi-Point Latch Options on 1 & 2 Tier



Angle Iron

Sizes and Dimensions

Angle Iron 1 Tier					
		Defiant II Latch		Cremone Turn Handle	
Opening Height		60"	72"	60"	72"
Width	Depth				
12"	12"	6WA103	6WA123	6WAT103	6WAT123
	15"	6WA104	6WA124	6WAT104	6WAT124
	18"	6WA105	6WA125	6WAT105	6WAT125
15"	12"	-	6WA128	-	6WAT128
	15"	6WA109	6WA129	6WAT109	6WAT129
	18"	6WA110	6WA130	6WAT110	6WAT130
18"	15"	6WA173	6WA183	6WAT173	6WAT183
	18"	6WA113	6WA133	6WAT113	6WAT133
	21"	6WA114	6WA134	6WAT114	6WAT134
	24"	6WA115	6WA135	6WAT115	6WAT135
24"	18"	6WA116	6WA136	6WAT116	6WAT136
	21"	6WA117	6WA137	6WAT117	6WAT137
	24"	6WA118	6WA138	6WAT118	6WAT138

Angle Iron 2 Tier					
		Defiant II Latch		Cremone Turn Handle	
Overall Height		60"	72"	60"	72"
Opening Height		30"	36"	30"	36"
Width	Depth	Cat. No.	Cat. No.	Cat. No.	Cat. No.
12"	12"	6WA203	6WA223	6WAT203	6WAT223
	15"	6WA204	6WA224	6WAT204	6WAT224
	18"	6WA205	6WA225	6WAT205	6WAT225
15"	12"	6WA208	6WA228	6WAT208	6WAT228
	15"	6WA209	6WA229	6WAT209	6WAT229
	18"	6WA210	6WA230	6WAT210	6WAT230
18"	15"	6WA273	6WA283	6WAT273	6WAT283
	18"	6WA213	6WA233	6WAT213	6WAT233
	21"	6WA214	6WA234	6WAT214	6WAT234

Angle Iron 3 Tier					
		Defiant II Latch		Cremone Turn Handle	
Overall Height		60"	72"	60"	72"
Opening Height		20"	24"	20"	24"
Width	Depth	Cat. No.	Cat. No.	Cat. No.	Cat. No.
12"	12"	6WA303	6WA323	6WAT303	6WAT323
	15"	6WA304	6WA324	6WAT304	6WAT324
	18"	6WA305	6WA325	6WAT305	6WAT325
15"	12"	6WA308	6WA328	6WAT308	6WAT328
	15"	6WA309	6WA329	6WAT309	6WAT329
	18"	6WA310	6WA330	6WAT310	6WAT330
18"	18"	6WA313	6WA333	6WAT313	6WAT333
	21"	6WA314	6WA334	6WAT314	6WAT334
	24"	6WA315	6WA335	6WAT315	6WAT335



The Angle Iron locker frame is highlighted in blue in this photo.

Angle Iron 6 Tier Box Locker		
		Friction Catch
Overall Height		72"
Opening Height		12"
Width	Depth	Cat. No.
12"	12"	6WA623
	15"	6WA624
	18"	6WA625
	21"	6WA626
	24"	6WA627
15"	12"	6WA628
	15"	6WA629
	18"	6WA630
	21"	6WA631
	24"	6WA632

Stadium®

Steel Lockers

At a Glance

- Knocked down or welded construction
- Open fronts and smooth frame channels
- 2 lockable compartment options
- 18", 24" and 33" wide models
- Tops, bottoms, sides, shelf and frames are 16 gauge
- Back is 18 gauge

Ventilation



Mini Louvers

Diamond perforated sides. Lockers equipped with a footlocker have Mini Louvers punched in the front panel.

Door Handle Options

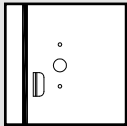

Friction Catch (O)

On models equipped with a Security Box

Accessories



Locking Security Box (O)



Footlocker (O)

O = Optional



For Stadium specifications, see page 41.

The Right Locker for Athletes and Their Equipment

Penco's Stadium lockers are ideally suited for athletic team rooms, fire fighter's equipment or any other application where easy access to uniforms and/or equipment is required.

They are available in different configurations: the minimum configuration has a full width shelf, 2 coat hooks and a coat rod. You can add a lockable security box, a lockable foot locker that doubles as a bench, or both. The open front and diamond perforated sides create full ventilation while allocating a specific storage space to each individual.

Fully accessorized, Stadium lockers are outfitted with a security box fastened to a full width shelf, and a footlocker with a hinged, reinforced seat at the base. Both compartments are lockable to secure valuable items. The front of the footlocker is recessed for an external padlock, and a stainless steel strike plate protects the finish. The footlocker design saves floor space by eliminating the clutter of open locker doors and the need for separate locker room benches.

Stadium lockers are available in All-Welded construction or K.D.

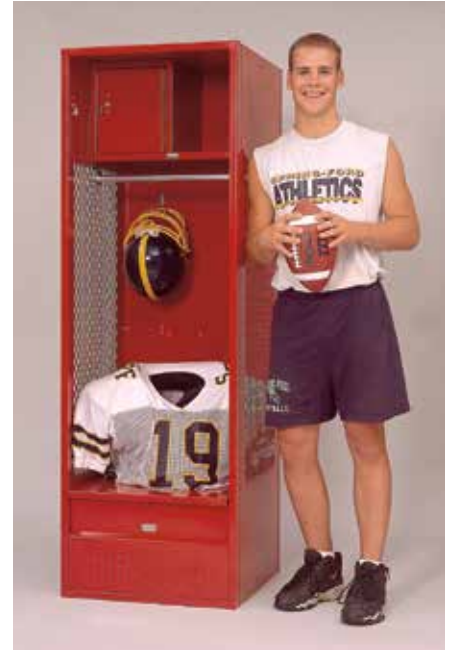

(knocked down, or unassembled). They are available in 18", 24" or 33" widths and 18", 21" or 24" depths. K.D. lockers are 72" high; All-Welded models have an integral 4" base, bringing the total height to 76".

Color selection is from any one of Penco's powder coat baked enamel decorator colors.



Sizes and Dimensions

K.D. Stadium Lockers with Perforated Sides

Width	Depth	Height	With Shelf	With Shelf & Security Box	With Shelf & Footlocker	With Shelf, Footlocker & Security Box
18"	18"	72"	6KFD01	6KFD09	6KFD02	6KFD03
24"	18"	72"	6KFD10	6KFD11	6KFD12	6KFD13
	21"	72"	6KFD20	6KFD21	6KFD22	6KFD23
	24"	72"	6KFD30	6KFD31	6KFD32	6KFD33
33"	18"	72"	6KFD40	6KFD41	6KFD42	6KFD43
	21"	72"	6KFD50	6KFD51	6KFD52	6KFD53
	24"	72"	6KFD60	6KFD61	6KFD62	6KFD63

Welded Stadium Lockers with Perforated Sides

Width	Depth	Height	With Shelf	With Shelf & Security Box	With Shelf & Footlocker	With Shelf, Footlocker & Security Box
18"	18"	76"	6WFD01	6WFD09	6WFD02	6WFD03
24"	18"	76"	6WFD10	6WFD11	6WFD12	6WFD13
	21"	76"	6WFD20	6WFD21	6WFD22	6WFD23
	24"	76"	6WFD30	6WFD31	6WFD32	6WFD33
33"	18"	76"	6WFD40	6WFD41	6WFD42	6WFD43
	21"	76"	6WFD50	6WFD51	6WFD52	6WFD53
	24"	76"	6WFD60	6WFD61	6WFD62	6WFD63



All-Welded
With 4" Base



KD
w/ Shelf



KD w/ Shelf
& Security Box

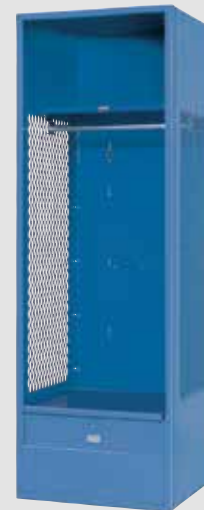

KD w/ Shelf
& Footlocker



KD w/ Shelf,
Security Box & Footlocker

Lockers for First Responders - Introduction

Penco Patriot® lockers are designed exclusively for first responders of all types: police, fire, military, EMS, etc. They are available in three basic versions: *Gear*, *Turnout* and *Duty*, all of which can be accessorized to suite your specific needs. See below and the following pages for detailed information, sizes and accessories.



 For Patriot specifications, see page 42.

Patriot Gear Lockers

See Page 21

When storing bulky protective or tactical gear, the size of the locker you select quickly becomes a factor. Gear models range from a big 24 inches wide to a massive 48 inches. All come standard with full height 14 gauge doors, beefy coat hooks and a 1" diameter coat rod.

- Construction – Welded or KD
- Height Available – 72". Welded Models Are 76" With Integral Base
- Widths Available – 24, 30, 36, 42 or 48"
- Ventilation – Louvered Doors. Diamond Perforated Sides.
- Lockable Compartments – Main doors, optional security box, drawer or footlocker
- Hanging – Heavy Duty Coat Rod and Hanging Hooks
- Latching – Cremone Handle



Patriot Turnout Lockers

See Page 22

Seconds count when it's your job to be the first to respond. The Patriot Turnout locker shares the same heavy gauge steel construction as the Gear and Duty lockers, but its open front and smooth frame mean you can retrieve your equipment in a flash.

- Construction – Welded or KD
- Heights Available – 72" Welded Models Are 76" With Integral Base.
- Widths Available – 24, 30, 36, 42 or 48"
- Ventilation – Open Front. Diamond Perforated Sides.
- Lockable Compartments – Optional security box, drawer or footlocker
- Hanging – Heavy Duty Coat Rod and Hanging Hooks
- Latching – Open Front



Patriot Duty Lockers

See Page 24

Duty lockers answer the call with law enforcement and security professionals in mind. A fully equipped interior featuring preconfigured compartments and additional private storage means what you need is where you need it when you need it.

- Construction – Welded or KD
- Heights Available – 60 or 72"
- Widths Available – 18 or 24"
- Ventilation – Perforated Top, Hat Shelf. Louvered Doors and Drawer
- Lockable Compartments – Main doors, drawer and interior side compartment
- Hanging – Heavy Duty Coat Rod and Hanging Hooks
- Latching – Cremone Handle
- Electrical Access – Single Gang Duplex Knockout In Top Panel



PATRIOT® Gear Lockers

Patriot Gear Lockers

A properly equipped double door Patriot Gear locker can be the ideal solution for a variety of specialized storage challenges. The ample storage areas at both top and bottom of the 24" wide model shown on this page still leave almost 4 feet between the shelves for hanging uniforms and other gear.

Distinguishing Features:

- All sizes are offered in welded or knocked down construction
- Integral channel base is standard on welded models
- Factory assembly available on KD models
- Double doors require less clear area in front of the locker to open
- 24 inch deep locker available in 24, 30, 36, 42 or 48 inch widths
- 18 inch deep locker available up to 36 inches wide
- Optional centered divider allows shelves and coat rods to be placed on either side during assembly
- Cremone handle standard on all Gear Lockers

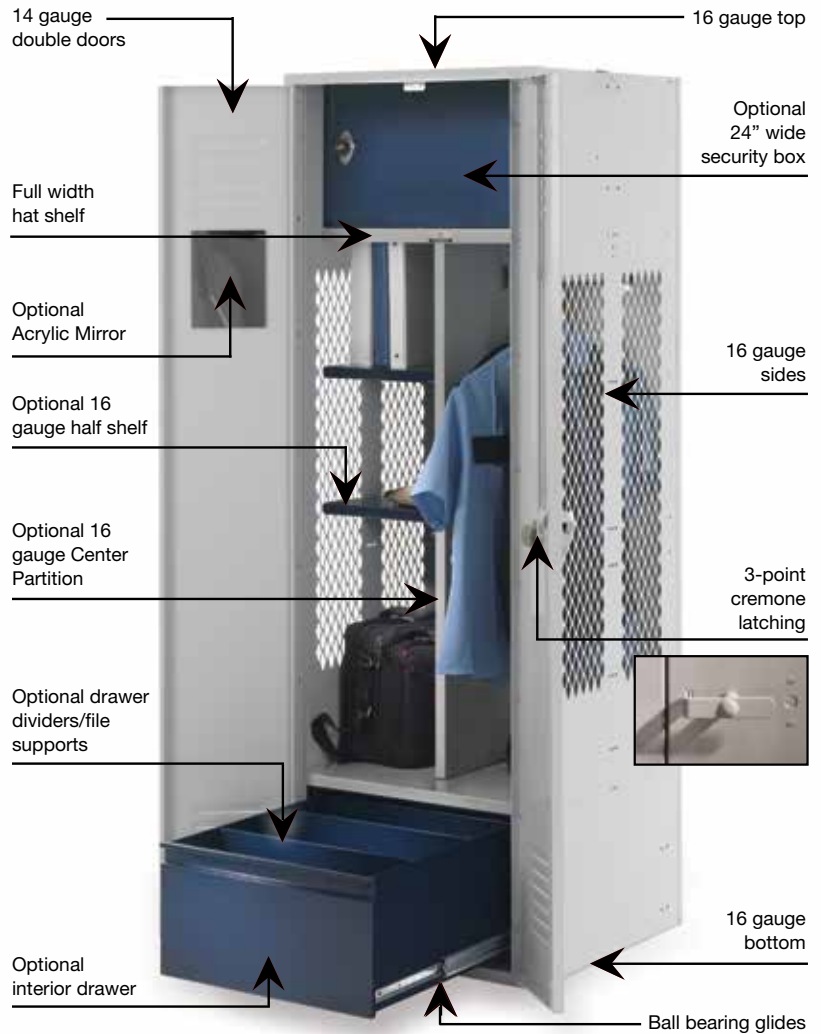

Patriot® Gear Lockers – 18" and 24" Deep

W x D		KD (Knocked Down) Construction		All-Welded Construction	
W	D	H	Cat. No.	H	Cat. No.
With 15" Deep Shelf					
18 (SD)	18	72	6KGDA84	76	6WGDA84C
24 (SD)	18	72	6KGDA94	76	6WGDA94C
24	18	72	6KGDA04	76	6WGDA04C
30	18	72	6KGDA14	76	6WGDA14C
36	18	72	6KGDA24	76	6WGDA24C
24	24	72	6KGDA00	76	6WGDA00C
30	24	72	6KGDA10	76	6WGDA10C
36	24	72	6KGDA20	76	6WGDA20C
42	24	72	6KGDA30	76	6WGDA30C
48	24	72	6KGDA40	76	6WGDA40C
With 21" Deep Shelf					
18 (SD)	24	72	6KGDA82	76	6WGDA82C
24 (SD)	24	72	6KGDA92	76	6WGDA92C
24	24	72	6KGDA02	76	6WGDA02C
30	24	72	6KGDA12	76	6WGDA12C
36	24	72	6KGDA22	76	6WGDA22C
42	24	72	6KGDA32	76	6WGDA32C
48	24	72	6KGDA42	76	6WGDA42C

NOTE: "(SD)" denotes Single Door. All others have Double Doors.



PATRIOT® Turnout Lockers

Patriot Turnout Locker

The key to any turnout locker is the ability to grab and go. The Patriot Turnout locker puts everything from flight gear to EMS equipment within reach. The open front and perforated sides aid in drying gear while available security boxes, drawers and footlocker provide a secure space for personal items.

Distinguishing Features:

- All sizes are offered in welded or knocked down construction
- Integral channel base is standard on welded models.
- Factory assembly available on KD models
- Open front and hemmed frame.
- 24 inch deep locker available in 24, 30, 36, 42 or 48 inch widths
- 18 inch deep locker available up to 36 inches wide.
- Number plates mount to the shelf face for easy visibility
- Sides are pre-punched on 12 inch vertical centers to accept additional shelves.



Patriot® Turnout Lockers – 18” and 24” Deep

W x D		KD (Knocked Down) Construction		All-Welded Construction	
With 15” Deep Shelf					
W	D	H	Cat. No.	H	Cat. No.
18	18	72	6KTDA84	76	6WTDA84C
24	18	72	6KTDA04	76	6WTDA04C
30	18	72	6KTDA14	76	6WTDA14C
36	18	72	6KTDA24	76	6WTDA24C
24	24	72	6KTDA00	76	6WTDA00C
30	24	72	6KTDA10	76	6WTDA10C
36	24	72	6KTDA20	76	6WTDA20C
42	24	72	6KTDA30	76	6WTDA30C
48	24	72	6KTDA40	76	6WTDA40C
With 21” Deep Shelf					
18	24	72	6KTDA82	76	6WTDA82C
24	24	72	6KTDA02	76	6WTDA02C
30	24	72	6KTDA12	76	6WTDA12C
36	24	72	6KTDA22	76	6WTDA22C
42	24	72	6KTDA32	76	6WTDA32C
48	24	72	6KTDA42	76	6WTDA42C



Gear and Turnout Locker Variations

One of the key strengths of the Patriot is its flexibility and modular accessories. Each Patriot accessory is designed for use in any of the four Patriot locker bodies.

Configure and Build to Suit

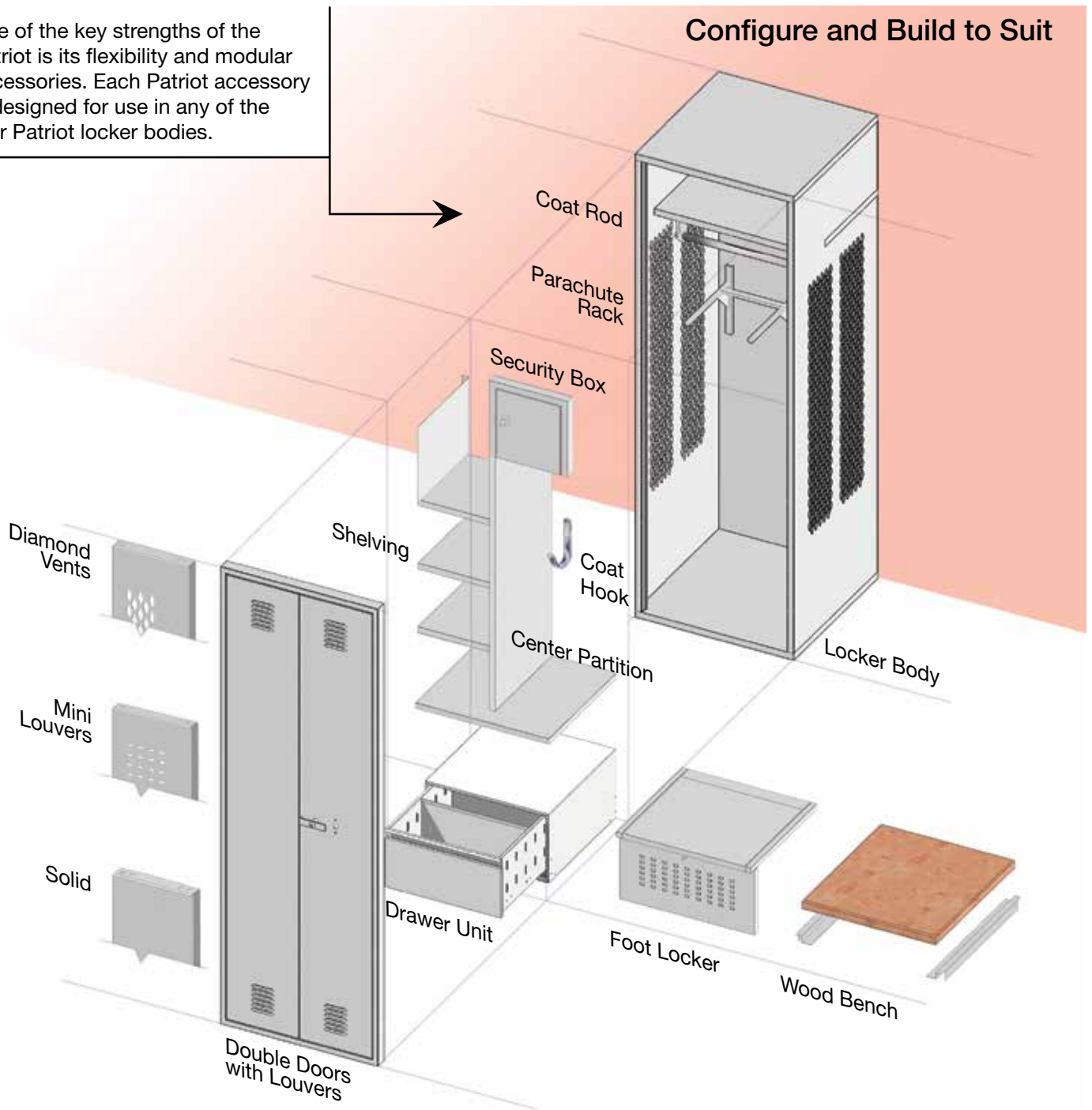

Cell Phone/Key Tray



Heavy Duty 1" Coat Rod with Brackets



Boot Tray

PATRIOT® Duty Lockers

Patriot Duty Lockers

Built for law enforcement applications, the big story behind the Duty locker is actually under it. A 14 gauge welded shell, 16 gauge drawer and ball bearing glides provide at no less than 3.4 cubic feet of usable storage in the Patriot Duty Locker's drawer base. The 33" deep base also accepts individual or continuous lengths of hardwood locker benches for seating (optional).

Distinguishing Features:

- All sizes offered in welded or KD construction
- Factory assembly available on KD models
- 16 gauge Interior Divider and Side Shelf
- Ventilation slots on Locker Top
- Hat Shelf Ventilated on Garment Side
- Heavy Duty Coat Rod and Hooks on Garment Side
- Lockable Security Compartment
- Duplex knockout on locker top
- 24 inch deep Locker with 21 inch deep accessories
- 60 inch and 72 inch heights available
- Available with or without the drawer base

Duty Locker Quick Facts

18" W Duty lockers have single doors; 24" W have double doors.
Drawer bases are welded and bolt to the lockers.
All Part numbers represent 1-wide units.
Cremone handles are standard on all models.



Patriot® Duty Lockers

Size		KD (Knocked Down) Construction	All-Welded Construction	
With 18" High Drawer Base				
W	D	H	Cat. No.	Cat. No.
18	24	60/78	64KD182478	64WD182478C
24	24	60/78	64KD242478	64WD242478C
18	24	72/90	64KD182490	64WD182490C
24	24	72/90	64KD242490	64WD242490C
With NO Base and NO Legs				
W	D	H	Cat. No.	Cat. No.
18	24	60	64KN182460	64WN182460C
24	24	60	64KN242460	64WN242460C
18	24	72	64KN182472	64WN182472C
24	24	72	64KN242472	64WN242472C
With 4" High Integral Channel Base				
W	D	H	Cat. No.	Cat. No.
18	24	64	-	64WCB182464C
24	24	64	-	64WCB242464C
18	24	76	-	64WCB182476C
24	24	76	-	64WCB242476C

Configure and Build to Suit

Duty Lockers have preconfigured interiors for storing and organizing a wide range of equipment. The available drawer base not only supports an integral seating surface but provides several additional cubic feet of storage.

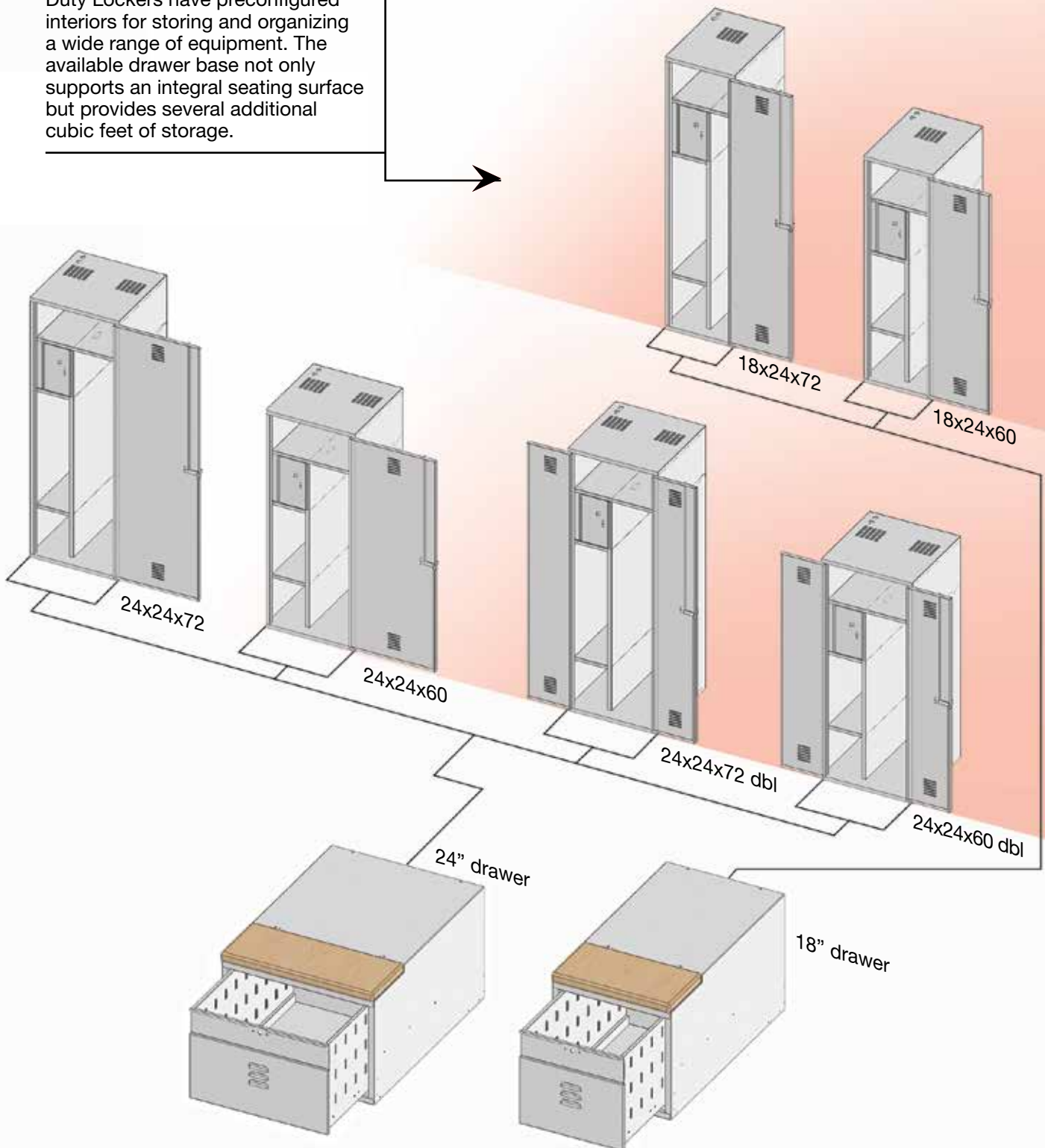

Duty Locker Details

There is more to the Duty locker than hand-picked features and a range of popular sizes.

Aside from continuous hinges, turn handles and heavy gauge bodies, they stand apart from their Gear and Turnout counterparts with features standard only on Duty models.

We've perforated the hat shelf over the garment side of the locker so you get air flow where it's needed without sacrificing storage.

The tops of all Duty lockers are punched with special 1/8 x 1 inch slots to provide ventilation without compromising security.

If you need power for charging radios, phones and laptops, your local electrician can remove the factory knockouts, mount receptacles and tie them into your building's electrical service.

The use of standard locker benches to span multiple drawer bases is recommended to provide smooth and continuous seating. Your installer can field cut as necessary, or we can provide custom lengths with field joints, mitered corners, and right or left hand ends based upon your layout drawing.



For Patriot specifications, see page 42.

Accessories for Patriot DUTY Lockers Only

Description	W	D	H	Cat. No.
Extra Side Shelves (Duty Only)	10	21	-	6SHX297C
Drawer Dividers (Duty Only)	18	-	18	64DD1818C
	24	-	18	64DD2418C
Individual Hardwood Seat (Duty Only)	18	9-1/2	1-1/4	6RQ1242
	24	9-1/2	1-1/4	6RQ0575
Bulk Length Hardwood Bench	-	9-1/2	1-1/4	Varies

For more Patriot accessories, see the next page.



Duty Locker top with single gang duplex electrical knockout and ventilation slots



1" diameter coat rod and brackets fastened beneath ventilated shelf on garment side



Duty Locker with drawer base and optional continuous hardwood bench and extra half shelves

-- Duty Locker Elevations --

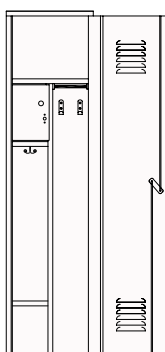

18" Wide/No Base
Welded or KD

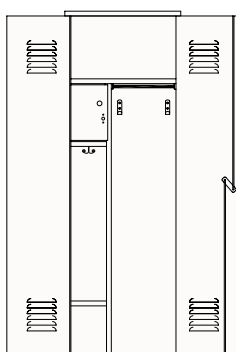

24" Wide/No Base
Welded or KD

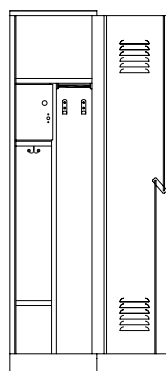

18" Wide/4" Base
Welded

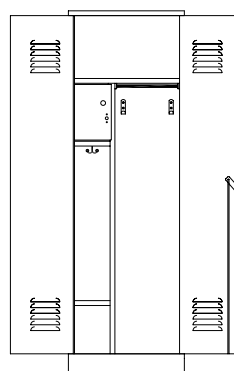

24" Wide/4" Base
Welded

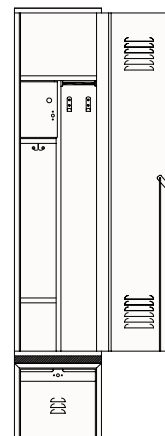

18" Wide/Drawer Base
Welded or KD

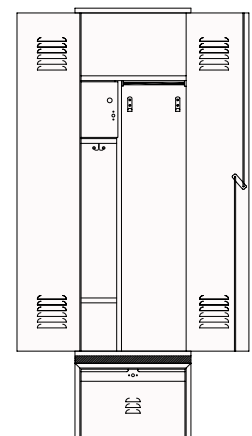

24" Wide/Drawer Base
Welded or KD

PATRIOT® Locker Accessories

Letter Codes below indicate where used: D=Duty, G=Gear, T=Turnout

Description		W	D	H	Cat. No.	
Center Partitions (G, T)	Hat Shelf to Locker Bottom	-	15	58	6CPX269C	
	Hat Shelf to Optional Bottom Shelf At 12 In.	-	15	45	6CPX270C	
	Hat Shelf to Locker Bottom	-	21	58	6CPX300C	
	Hat Shelf to Optional Bottom Shelf At 12 In.	-	21	45	6CPX301C	
Full Width Bottom Shelf (G, T) (Required with Drawers)		18	18	-	6SHX695C	
		24	18	-	6SHX575C	
		30	18	-	6SHX576C	
		36	18	-	6SHX577C	
		18	24	-	6SHX696C	
		24	24	-	6SHX530C	
		30	24	-	6SHX531C	
		36	24	-	6SHX532C	
Full Width Intermediate Shelf (G, T) (Punched for Center Partition. Face is NOT punched for number plate.)		42	24	-	6SHX533C	
		48	24	-	6SHX534C	
		18	15	-	6SHX700C	
		24	15	-	6SHX708C	
		30	15	-	6SHX709C	
		36	15	-	6SHX710C	
		42	15	-	6SHX803C	
		48	15	-	6SHX804C	
		18	21	-	6SHX699C	
		24	21	-	6SHX703C	
Half Shelves for use with Center Divider (G, T) (Match Half Shelf and Divider to Hat Shelf depth)		30	21	-	6SHX704C	
		36	21	-	6SHX705C	
		42	21	-	6SHX706C	
		48	21	-	6SHX707C	
		9	15	-	6SHX697C	
		12	15	-	6SHX521C	
		15	15	-	6SHX522C	
		18	15	-	6SHX523C	
		21	15	-	6SHX524C	
		24	15	-	6SHX525C	
		9	21	-	6SHX698C	
		12	21	-	6SHX561C	
Footlocker (G, T) (Not for use with Center Dividers)		15	21	-	6SHX562C	
		18	21	-	6SHX563C	
		21	21	-	6SHX564C	
		24	21	-	6SHX565C	
		18	18	12	6ACXHK58H	
		24	18	12	6ACXHK90H	
		30	18	12	6ACXHK91H	
		36	18	12	6ACXHK92H	
		18	24	12	6ACXHK59H	
		24	24	12	6ACXAB93H	
Security Box (G, T) (Select by Hat Shelf depth)		30	24	12	6ACXAB94H	
		36	24	12	6ACXAB95H	
		42	24	12	6ACXAB96H	
		48	24	12	6ACXAB97H	
		12	15	12	6ACXAB98H	
		24	15	12	6ACXAB99H	
Drawer Unit - Requires Bottom Shelf (G, T)		12	21	12	6ACXHM53H	
		24	21	12	6ACXHM54H	
	Drawer Unit for 18" Wide Used when ordering an 18" wide Patriot locker and one 18" drawer unit is required.		18	18	12	6ACXHN70C
			18	24	12	6ACXHN10C
			18	18	15	6ACXHN80C*
			18	24	15	6ACXHN20C*
	18" Drawers for 36" & 42" Wide Used when ordering a 36" wide Patriot locker & either one 18" drawer or two 18" drawer units are required.		18	18	12	6ACXFF82C
			18	24	12	6ACXFF60C
			18	18	15	6ACXFF87C*
			18	24	15	6ACXFF20C*
	Drawer Unit for 24", 30", 42" & 48" Wide 48" wide drawer units consist of two 24" wide drawers. A 24" wide drawer can be combined with an 18" wide drawer (above) in a 42" wide Patriot locker. If a 45" high Center Partition & Metal Bottom Shelf are used, select the 12" high drawer.		24	18	12	6ACXFF83C
			30	18	12	6ACXFF84C
		24	18	15	6ACXFF88C*	
		30	18	15	6ACXFF89C*	
		24	24	12	6ACXFF61C	
		30	24	12	6ACXFF62C	
		24	24	15	6ACXFF21C*	
		30	24	15	6ACXFF22C*	

* 15" high Drawer Units are not for use with Center Divider

Description		W	D	H	Cat. No.
Drawer Divider (G, T) (Two required for Hanging File Folders)		18	-	12	6ACXAB80C
		24	-	12	6ACXAB81C
		30	-	12	6ACXAB82C
		18	-	15	6ACXAB83C
		24	-	15	6ACXAB84C
	30	-	15	6ACXAB85C	
Document Sleeves (G, T, D)		12	3	8	6ACXFF54C
		10	3	8	6ACXAB32C
Parachute / Body Armor Rack (G, T)		-	18	-	6ACXAB33C
Adhesive Acrylic Mirror (G, T, D)		6	-	8	96370
Cell Phone/Key Tray (G, T, D)		8	2	2	60830H
Heavy Duty Coat Hook (G, T, D)		-	2	3	6ACXAB37H
Coat Rods (G, T) 1" Diameter, shelf mount only (with light gray brackets)		9	-	-	6ACXHM50H
		12	-	-	6ACXAB38H
		15	-	-	6ACXAB39H
		18	-	-	6ACXAB40H
		21	-	-	6ACXAB41H
		24	-	-	6ACXAB42H
		30	-	-	6ACXAB43H
		36	-	-	6ACXAB44H
		42	-	-	6ACXAB45H
		48	-	-	6ACXAB46H
Garment Separators (G, T)		12	-	5	6ACXFF00H
		15	-	5	6ACXFF01H
		18	-	5	6ACXFF02H
		21	-	5	6ACXFF03H
		24	-	5	6ACXFF04H
		30	-	5	6ACXFF05H
		36	-	5	6ACXFF06H
		42	-	5	6ACXFF07H
	48	-	5	6ACXFF08H	
Boot Tray ** (G, T, D)		14	12	-	6ACXFF09H
Accessory Mounting Plate (G, D) (To mount accessories to left side door)		12	-	24	6ACXFF10H
		15	-	24	6ACXFF11H
		18	-	24	6ACXFF12H
		21	-	24	6ACXFF13H
	24	-	24	6ACXFF14H	
Hardwood Bench Seat (G, T) (Not for use with Center Divider)		18	18	-	6RQ1317BH
		24	18	-	6RQ1305BH
		30	18	-	6RQ1306BH
		36	18	-	6RQ1307BH
		18	24	-	6RQ1318BH
		24	24	-	6RQ1232BH
		30	24	-	6RQ1233BH
		36	24	-	6RQ1234BH
Metal Seat (G, T) (Not for use with Center Divider)		42	24	-	6RQ1235BH
		48	24	-	6RQ1236BH
		18	18	-	6ACXHM51H
		24	18	-	6ACXHK97AH
		30	18	-	6ACXHK98AH
		36	18	-	6ACXHK99AH
		18	24	-	6ACXHM52H
		24	24	-	6ACXFF49AH
	30	24	-	6ACXFF50AH	
	36	24	-	6ACXFF51AH	
	42	24	-	6ACXFF52AH	
	48	24	-	6ACXFF53AH	
Name Card Holder (G, D)		-	-	-	9446H

** When a Boot Tray is used in a DUTY locker, it must be a 24 inch wide locker ONLY.

Steel Lockers

Accessories / Locker Growth

The illustration below shows several locker groups with frequently ordered accessories.

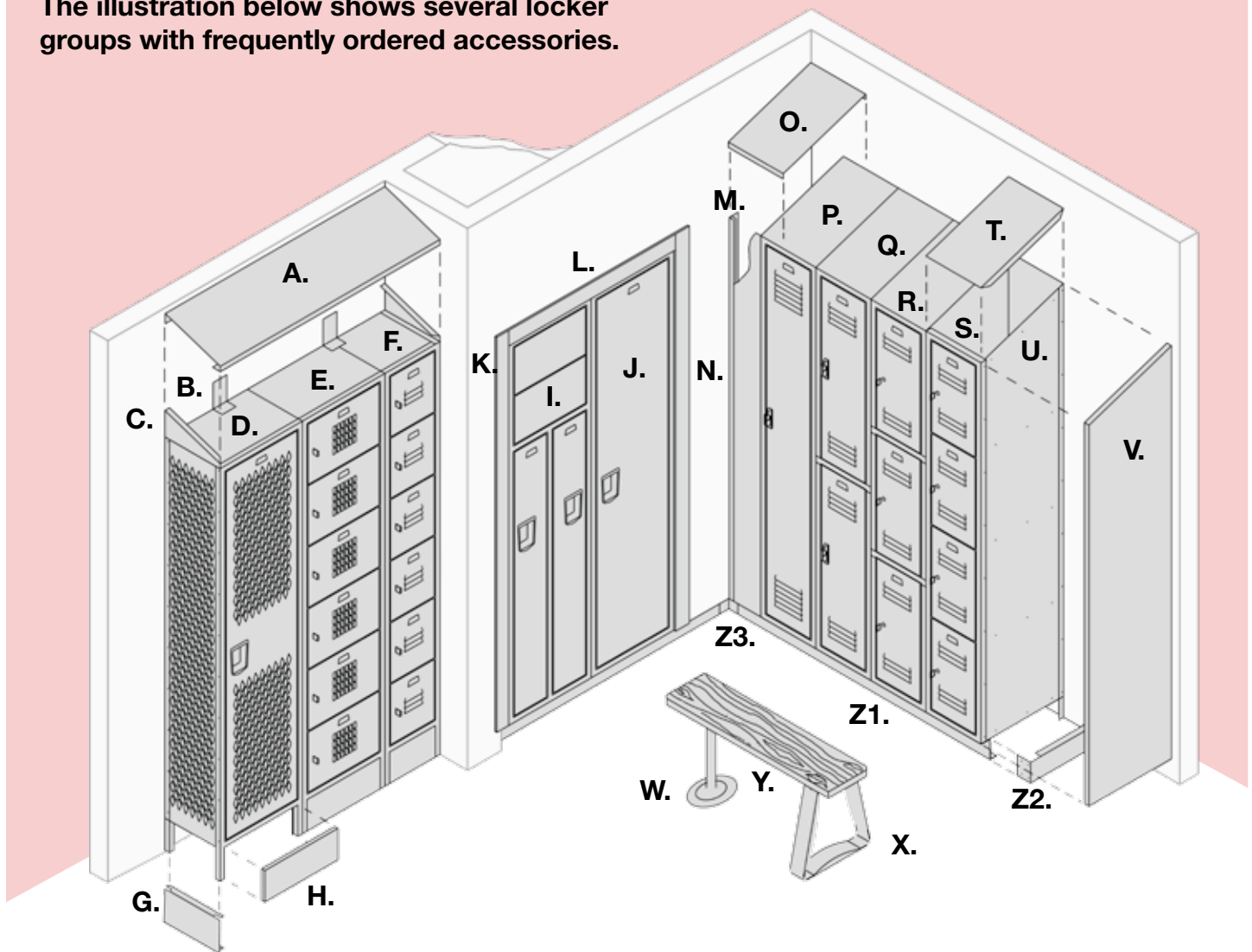

Key for Illustration

- | | | |
|---|---------------------------------|---|
| A. Slope Hood | J. Single Tier Guardian | T. Slope Top, Unit Construction |
| B. Universal Rear Hood Support | K. Side Recess Trim | U. Slope Top Division (Side) |
| C. Slope End for Hood L.H. (Left Hand) | L. Top Recess Trim | V. Finished End Panel (Right Hand) |
| D. Single Tier Invincible | M. Wall Angle Slip Joint | W. Heavy Duty Bench Pedestal |
| E. 6 Tier Box Locker w/Visual Doors | N. Vertical Filler | X. Stainless Steel Bench Pedestal |
| F. 6 Tier Box Locker w/Std. Louvers | O. Filler, Slope Top | Y. Hardwood Bench |
| G. End Base, 6" High | P. Single Tier Vanguard | Z1. Zee Base, 4" high |
| H. Front Base, 6" High | Q. Double Tier Vanguard | Z2. Zee End Base/Splice |
| I. Two Person Guardian | R. Three Tier Vanguard | Z3. Zee Inside Corner Splice |
| | S. Four Tier Vanguard | |

Locker "Growth"

When planning an installation of KD lockers, allow an additional 1/16" for each frame. When planning an installation of Welded lockers, allow an additional 1/16" per group. For Angle Iron lockers, contact your Penco representative.

Steel Lockers

Accessories

Slope Top Construction

Slope tops are often used instead of flat tops to prevent the accumulation of dust and debris, and to discourage the use of locker tops as storage areas. There are three different types of slope top construction: Unit Slope Tops, Slope Hoods, and Slope Top Kits. Each is explained below.

Unit Slope Tops



Unit Slope Tops cover the width of one locker frame only. Lockers with Unit Slope Tops have sides with mitered top ends with a rise equal to 1/3 of the locker depth, plus longer backs

that meet the rear edge of the slope top. Unit slope tops are used in place of the standard flat tops. Order the appropriate locker plus the proper slope top size. Not for use on Invincible II, Welded, Stadium or Patriot lockers.

Slope Top Kits



Designed to convert stock flat top lockers into slope top lockers in groups of 3 wide. Each kit contains 3 tops, 3 backs and 4 ends. Not for use on Invincible II, Welded, Stadium or

Patriot lockers.

Universal Rear Hood Support

Used with 12", 15", 18", 21" and 24" deep hood only.

Typical Slope Hood Installation

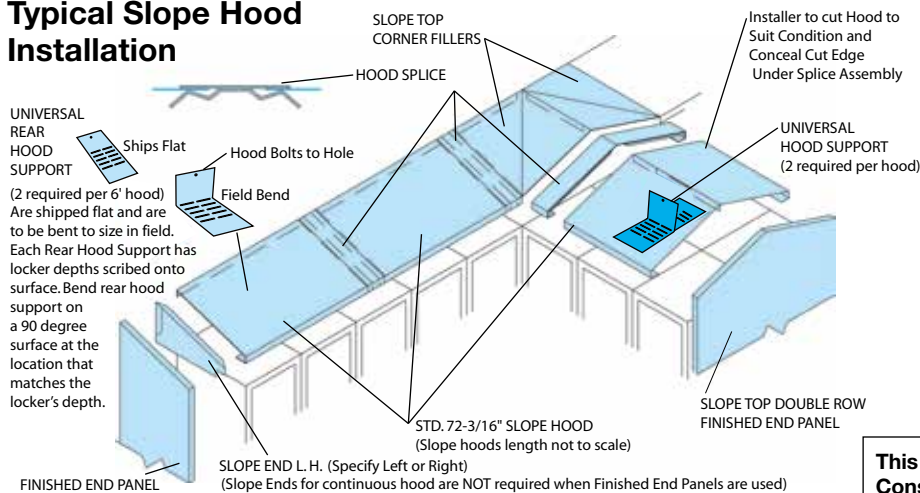

Continuous Slope Hoods

Continuous slope hoods fit on top of flat top lockers. They can be used on new lockers or on a retrofit basis. All hoods are furnished in 72" lengths and must be cut to length during installation. Intermediate splices, ends and rear supports (2 per hood) complete the installation, and must be ordered separately. Includes 1 piece of hood and 2 hood supports.

Continuous Slope Hoods

Unit Length	Unit Depth	Unit Height	Cat. No.
72"	13"	5.3"	6HDX330H
	16"	6.3"	6HDX124H
	19"	7.3"	6HDX471H

Use only when lockers need to be 1 inch away from wall. Includes 1 piece of hood and 2 hood supports. Do NOT use with STANDARD size Slope Ends, Slope Top Corner Fillers, Hip Fillers or Finished End Panels. See special Splices & Hood Supports for these hoods below.

Continuous Slope Splice

Unit Depth	Cat. No.
13"	6HDX484C
16"	6HDX127C
19"	6HDX473C

Continuous Slope Supports

Unit Height	Cat. No.
5.3"	6HDX480C
6.3"	6HDX481C
7.3"	6HDX474C

Continuous Hood Ends

Left/Right	Unit Depth	Unit Height	Cat. No.
LH	13"	5.3"	6HDX642H
RH	13"	5.3"	6HDX643H
LH	16"	6.3"	6HDX125H
RH	16"	6.3"	6HDX126H
LH	19"	7.3"	6HDX694H
RH	19"	7.3"	6HDX695H

Unit Slope Tops

Unit Width	Unit Depth	Cat. No.
9"	12"	60332C
	15"	60334C
	18"	60336C
12"	12"	60338C
	15"	60340C
	18"	60342C
15"	21"	60344C
	12"	603450C
	15"	60346C
18"	18"	60348C
	21"	60350C
	18"	60352C
24"	18"	60354C
	24"	60356C
	18"	60364C
24"	21"	60366C
	24"	60368C

Slope Top Kits - 3 Wide

Unit Width	Unit Depth	Unit Height	Cat. No.
12"	12"	4"	60230H
	15"	5"	60232H
	18"	6"	60234H
15"	15"	5"	60238H
	18"	6"	60240H
18"	18"	6"	60244H

Slope Hoods*

Unit Depth	Unit Height	Unit Width	Cat. No.
12"	5"	72"	66144H
15"	6"	72"	66147H
18"	7"	72"	66150H
21"	8"	72"	66153H
24"	9"	72"	66156H

*Includes 1 piece of hood and 2 hood supports.

Slope Ends

Unit Depth	Unit Height	Left Hand Cat. No.	Right Hand Cat. No.
12"	5"	66158H	66159H
15"	6"	66160H	66161H
18"	7"	66162H	66163H
21"	8"	66164H	66165H
24"	9"	66166H	66167H

Hood Splice

Unit Depth	Unit Height	Cat. No.
12"	5"	66168C
15"	6"	66169C
18"	7"	66170C
21"	8"	66171C
24"	9"	66172C

This is a partial overview of available accessories. Consult your Penco representative for a complete list.

Steel Lockers

Accessories

Individual Closed Bases

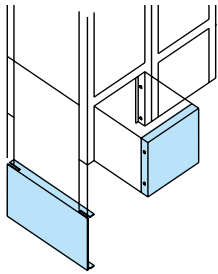

Front and end bases are designed to fit between standard Penco 6" legs. They present a clean flush appearance and prevent the accumulation of dust and dirt under the lockers. Front Base snaps in; End Base slips over legs during locker assembly. Only available for knocked down lockers with 6" legs.

Zee Bases

Zee bases raise lockers without legs 4" off the floor when there is no concrete or wood base. They provide a toe space in the front and a concealed flange for floor anchoring at the rear. A special 4" high rear leg can be ordered to support the back of the locker. (6" high zee bases are also available.)

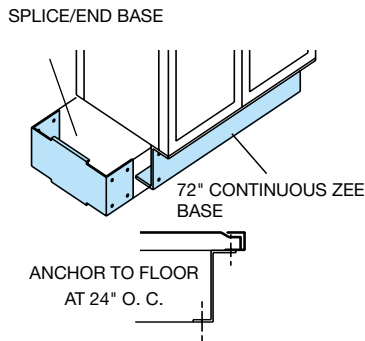

Zee bases are available only in 72" lengths, and may need to be cut to fit at the time of installation. Splices/End Bases are used at ends of rows, and where the front sections join. Not for use on Welded, Stadium or Patriot lockers.

Fillers

Penco provides standard fillers to adapt lockers to a wide range of field conditions and provide a professional, finished appearance. Fillers can be used to cover columns, pipes or other obstacles in a row of lockers, or fill the gap between the lockers and a wall.

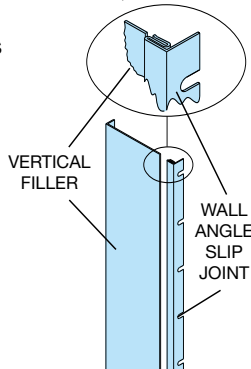

Vertical Fillers. These come in three widths and are designed to be used in conjunction with Wall Angle Slip Joints for a solid fit and smooth finish. The slip joint conceals any raw edges caused by field cutting. Additional sizes are available. (Illustration at right.)

Top Fillers. Top Fillers cover gaps between tops of lockers. They overlap the locker tops and can be field cut to allow for pipes, etc. There are separate designs for flat top and slope top, and in-line vs. corner applications (illustration below).

Slope Top Fillers are not to be used with slope hoods. Slope Top Corner fillers can be used with Slope Hoods or Unit Slope Tops

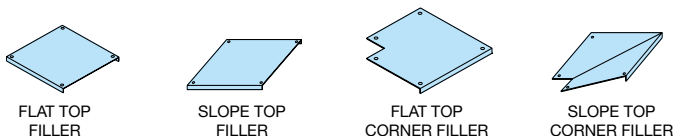

Individual Closed Bases - 6" High

Unit Width	Unit Depth	Cat. No.
Front Bases		
9"	-	60216C
12"	-	60217C
15"	-	60218C
18"	-	60219C
24"	-	60220C
End Bases Single Row		
-	12"	60204C
-	15"	60205C
-	18"	60206C
-	21"	60207C
-	24"	60208C
End Bases Double Row		
-	24"	60209C
-	30"	60210C
-	36"	60211C

Zee Bases - 72" Width

Unit Depth	Unit Height	Cat. No.
Front Zee Bases		
-	4"	66700H
Splice/End Base Single Row		
12"	4"	66701H
15"	4"	66702H
18"	4"	66703H
21"	4"	66704H
24"	4"	66705H
Splice/End Base Double Row		
30"	4"	66707H
24"	4"	66706H
36"	4"	66708H
Zee Inside Corner Splice		
-	4"	66709H
Rear Leg for Zee Base		
-	4"	60092C

Vertical Fillers

Unit Width	Unit Height	Cat. No.
Vertical Angles		
5"	60"	66112C
	72"	66115C
9"	60"	66114C
	72"	66117C
	78"	66127C
12"	60"	66113C
	72"	661141C
	78"	66116C
Wall Angle Slip Joints		
-	60"	66118C
-	72"	66119C
-	78"	66121C

Top Fillers

Unit Width	Unit Depth	Cat. No.
Flat Top Fillers		
15"	12"	661321C
	15"	661322C
	18"	661323C
Slope Top Fillers		
15"	12"	661371C
	15"	661372C
	18"	661373C
Flat Top Corner Fillers		
12"	12"	66138C
15"	15"	66139C
18"	18"	66140C
Slope Top Corner Fillers		
12"	12"	66100C
15"	15"	66101C
18"	18"	66102C

Steel Lockers

Accessories

Extra Steel Locker Shelves



Extra locker shelves can be added to K.D. lockers to meet special user requirements. Most lockers have extra holes already punched into side panels for mounting. In some cases shelf mounting holes may need to be drilled. Please consult your Penco sales representative for shelf mounting requirements.

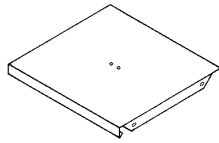

Pictured: Single Tier Vanguard Locker with 5 shelves.



Recess Trim

Recess trim is 3" wide and bridges the gap between lockers and wall and/or soffits when the lockers are recessed into a wall. Side trim for left hand (LH) and right hand sides (RH) are different. Side Trim comes in three types: 1) for use with lockers with no legs, 2) with 6" legs and 3) for use with Bottom Recess Trim.

The soffit is to be constructed by general contractor. Face of soffit must be flush with face of locker. There should be 1" between top of locker and bottom of soffit. The recessed trim extends 3/8" from face of soffit.

Recess Trim - 3" High		
Unit Width	Unit Depth	Cat. No.
Top Trim		
74"	-	60456H
Splice		
2"	-	66105C
Outside Corner Splice		
2"	2"	66108C
Bottom Trim		
72"	-	60458C

Front View of Locker with Recessed Trim
Lockers must be anchored to base (base and wood to be completed by General Contractor)

A. Vanguard w/optional full louvers
B. Vanguard w/ recessed handle
C. Fire extinguisher / waste bin door
D. Vanguard w/optional visual perf
E. Invincible II

Example of Side View of Base and Anchor

Top View of 3" Vertical Trim R.H.

Top View of a Recessed Locker Grouping
Recessed Opening = Length of Locker Group (w/growth) + 3"

Side View of Top Recessed Trim

Recess Side Trim - 3" Wide	
Unit Height	Cat. No.
Side Trim - LH (Use with lockers that have No Legs)	
63"	60465C
75"	60469C
87"	60473C
Side Trim - RH (Use with lockers that have No Legs)	
63"	60466C
75"	60470C
87"	60474C
Side Trim - LH (Use with Top Trim & 6" Legs)	
69"	60467C
81"	60471C
93"	60475C
Side Trim - RH (Use with Top Trim & 6" Legs)	
69"	60468C
81"	60472C
93"	60476C
Side Trim - LH (Use with Top & Bottom Trim)	
66"	60477C
78"	60479C
90"	60481C
Side Trim - RH (Use with Top & Bottom Trim)	
66"	60478C
78"	60480C
90"	60482C

Steel Lockers

Accessories

Locking System Options

Built-in Key Locks. Available in flat key or grooved key models. Dead bolt and spring bolt construction. Reversible for LH & RH applications.



Built-in Combination Locks. Available with five combination changes for security year to year. Master key controlled. Stainless steel escutcheon plate. Use dead bolt models for all but box lockers, which use spring bolt. Available in LH & RH.



Combination Padlocks. Available with and without master keying. 3 number dialing. Rust resistant. Fits box lockers, Die-Cast Handles, recessed handles, cremone handles and basket racks.



Note: For proper fit and security, padlock shackle must have a diameter of 9/32" or 5/16" and a distance of .75" to .81" between the top of the case and the underside of the shackle when in the locked position.

Coin Operated. Ideal for public or private applications that require security with the assurance that keys will be returned, or as a revenue producer. Fits most Penco lockers. Available in 3 types: coin return, coin collect and token operation. Not available for Defiant lockers.



ADA Compliant Locks

Key Lock Model No. 9707. Just insert key (turning not required) and lift latch pull to open door.



Key Lock Model No. 9676A. Has an oversized keyhead to facilitate turning.

Battery Powered Lock. ADA compliant lock that opens by touching a Button Key to the lock. When opened, an LED light flashes and audio indicator sounds. Lock uses programming key to set user access and a master key for administrative or management use.



Benches and Pedestals

A natural accessory for any locker room. Benches add permanent comfort and order to the floor plan arrangement.

Penco offers a choice of bench pedestal styles. Order two pedestals for standard benches 96" long or less; order three pedestals for benches over 96" long. The seat portion of ADA benches require a minimum of 4 pedestals, placed as shown in the photo of the Bench Bracket.

Wood Bench Tops

Exceptionally strong wood locker room benches finished with clear lacquer.

For ADA (Americans With Disabilities Act) compliant benches, use 16" or 18" deep bench backs and 20" or 24" deep seats plus Bench Brackets to support the backs. Order Pedestals separately.

Bench Tops			
Unit Width	Unit Depth	Unit Thickness	Cat. No.
Standard Bench Tops			
36"	9-1/2"	1-1/4"	9611
48"	9-1/2"	1-1/4"	9600
48"	12"	1-1/4"	9622
60"	9-1/2"	1-1/4"	9601
72"	9-1/2"	1-1/4"	9602
84"	9-1/2"	1-1/4"	9603
96"	9-1/2"	1-1/4"	9604
108"	9-1/2"	1-1/4"	9605
120"	9-1/2"	1-1/4"	9606
132"	9-1/2"	1-1/4"	9607
144"	9-1/2"	1-1/4"	9608
ADA Compliant Benches			
42"	16"	1-1/4"	9634
48"	16"	1-1/4"	9635
42"	18"	1-1/4"	9625
48"	18"	1-1/4"	9628
42"	20"	1-1/4"	9636
48"	20"	1-1/4"	9632
42"	24"	1-1/4"	9624
48"	24"	1-1/4"	9623

A. Heavy Duty Bench Pedestal

16-1/4" high pedestal consists of a heavy duty steel tube welded to top and bottom flanges. Hardware for fastening to the bench only is included. Pedestal must be anchored to the floor. Order two or more per standard bench; four or more for ADA compliant bench. Available for quick shipment in 028 Gray and 073 Champagne. Available on production schedules in all standard colors. Cat. No. 60822H

B. Stainless Steel Free Standing Pedestal

This pedestal has a 14" wide base which allows for moveable free standing use. Holes in the bottom are provided for optional floor anchoring or for attachment of non-skid bumpers (see below). Hardware is supplied for fastening to the bench top. Height is 16-1/4". Cat. No. 60827H each.



Non-Skid Pedestal Kit for Stainless Steel Pedestal

Rubber non-skid bumpers to prevent damage to floors. Consists of set of 4 non marking rubber feet and fastening hardware. Order 1 kit per pedestal. Cat. No. 68420

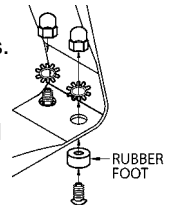

Bench Bracket for Back of ADA Benches

For attaching 16" or 18" backrest to 20" or 24" deep benches for ADA use. Sturdy steel construction. Order a minimum of 2 per back.



Size is 19" x 19" x 2". Hardware included. Cat. No. 6ACXHP61H

Mirror

Made of acrylic plastic that will not break in normal usage. Mirror has an adhesive backing for easy installation. Size is 6" wide x 8" high. Cat. No. 96370



Steel Lockers

Basket Racks/Special Purpose Lockers

Basket Racks



An economical shelving rack specially designed to accommodate wire baskets for storage of athletic apparel, swimming trunks, etc. Ideal for schools, YMCA's, clubs and other organizations with swimming pools and gym facilities.

Penco basket racks' open type construction with 13 ga. posts and 20 gauge shelves permits free circulation of air and easy visual inspection. Stability is achieved through the use of 12 ga. cross braces. 3" high 20 ga. dividers

between baskets and at ends of rows make basket contents inaccessible from adjacent openings.

Backs of shelves are turned down to form a backstop to prevent baskets from being removed from the rear. Aluminum number plates with 3/8" high black letters and 14 gauge padlock hasp are furnished for each opening and fasten to the front edge of the shelf. Number plate sequence must be specified when ordering. Units may be bolted together to form a double faced rack. Racks are 40" wide x 13-3/16" deep. Units can be equipped with casters. Order baskets separately.

Baskets



Three styles of baskets are available: **A.** Perforated plate front and rear with wire on sides and bottom; **B.** Same as above, except with "Pilfer Guard", and extra plate that covers the top front of the basket; **C.** All plated wire construction. All are nominally 13" D x 8" H. Baskets can be supplied with number plates corresponding to shelf position. Number sequence must be furnished with the order.

Food Industry Lockers



For ease of cleaning beneath lockers. Leg extensions increase the 6" height to 16". Order as piece parts or in a kit specially designed for 18" deep lockers. Kits include supports for a hardwood bench (order bench separately). Lockers must have standard 6" legs. Not for use with Welded, Stadium or Patriot lockers.

Fire Extinguisher Door and Waste Bin door



Lockers can be designated to contain a fire extinguisher door and/or a waste receptacle. The opening on the fire extinguisher door is glazed with wire-reinforced glass.

Waste bin doors have a cut-out with an internal flap and a top spring-loaded hinge to keep the opening closed when not being used. There is a small metal chute inside the door to direct the waste to a waste container (container is not included).

These items are typically ordered in 12" or 15" wide 1 and 2 tier lockers. If recessed handles are used, the width must be a minimum of 15" wide. Locks should not be used on fire extinguisher doors or waste bin doors.

Basket Racks

Levels/ Basket Capacity	Unit Width	Unit Depth	Unit Height	Cat. No.
9" Wide Baskets, 4 Baskets Wide				
7/28	40"	13"	70"	65910
8/32	40"	13"	79"	65930
12" Wide Baskets, 3 Baskets Wide				
7/21	40"	13"	70"	65800
8/24	40"	13"	79"	65830

Baskets

Unit Width	Unit Depth	Unit Height	Cat. No.
A. Perforated Front			
9"	13"	8"	9646
12"	13"	8"	9641
B. Perforated Front w/ Pilfer Guard			
9"	13"	8"	9642
12"	13"	8"	9643
C. All Wire			
9"	13"	8"	9621
12"	13"	8"	9620

Food Industry Locker Conversion

Unit Width	Unit Depth	Unit Height	Cat. No.
Kits, 18" Depth			
1 Wide	-	16"	64001
3 Wide	-	16"	64003
Rear Leg			
-	-	16"	65540H
Bench Support			
-	18"	-	65541H
End Front Leg			
-	-	16"	65542H
Intermediate Front Leg			
-	-	16"	65543H

Specifications

Vanguard™ Lockers (KD)

Materials

Sheet Steel: All parts made from prime grade mild cold rolled sheet steel from surface imperfection, and capable of taking a high grade enamel finish.

Hinges: .074" thick, 2" high, double spun, full loop, tight pin, five-knuckle butt hinges, projection welded to door frame and securely fastened to the door with 2 steel rivets. Doors over 48" high shall have three hinges, all other doors shall have two hinges.

Finishing: Chemically pretreat metal with a multiple stage cleaning and metal preparation process. Finish coat shall be electrostatically applied powder coat enamel properly cured to paint manufacturer specifications to achieve optimum performance. All lockers shall be painted inside and outside with the same color.

Equipment: Coat hooks and coat rods are zinc plated. Truss fin head bolts and hex nuts are zinc plated.

Fabrication General

Construction: Built on the unit principle - each locker shall have an individual door and frame, individual top, bottom, back and shelves with common intermediate uprights separating compartments. Lockers shall be fabricated square, rigid and without warp. Doors shall be flat and free of distortion.

Door Frame: All door frame members to be not less than 16 gauge formed to a channel shape. Vertical members to have an additional flange to provide a continuous door strike. Intermembering parts to be mortised and tenoned and electrically welded together in a rigid assembly capable of resisting strains.

Cross frame members of 16 gauge channel shapes including intermediate cross frame on double and triple tier lockers shall be securely welded to vertical framing members to ensure rigidity.

Body: Bolt spacing in locker body construction not to exceed 9" o.c. All locker body components shall be made of cold rolled steel specially formed for added strength and rigidity and to ensure tight joints at fastening points. Tops & bottoms shall be 24 gauge with three sides formed 90° and the front offset formed to be flush with the horizontal frame member. Shelves shall be 24 gauge with four sides formed to 90°, the front edge shall have a second bend. Backs & sides shall be 24 gauge.

Doors: Doors 30" or higher shall be formed from one piece 16 gauge cold rolled sheet steel. Doors less than 12" wide shall be minimum of 18 gauge. Formations shall consist of a full channel shape on the lock side of adequate depth to fully conceal the lock bar, channel formation on the hinge side, and right angle formations across the top and bottom. Doors over 15" wide x 60" & 72" high shall have a 3" wide 20 gauge full height reinforcing pan welded to the inside face of the door on 6" centers.

Doors for box lockers 3, 4, 5, and 6 tier high shall have channel formations on lock and hinge side and have right angle flanges on the top and bottom. Doors less than 15" wide shall be 18 gauge, 15" wide or wider shall be 16 gauge. Box locker door for 3, 4, 5, and 6 openings high shall

be pre-punched for padlock latch and friction catch and built-in combination and key locks.

Door Handle 1 & 2 Tier, 2 Person & Duplex: Handle to consist of zinc alloy die-cast case and handle. 40,000 PSI maximum tensile strength, chrome plated. Handle to be pulled out to move up latch bar and open door in one motion. Padlock eye for use with 9/32" diameter padlock shackle to be an integral part of handle and to be so located that extension of handle forms a padlock strike. Attachment to latch bar shall be tamper-proof and concealed inside the door. The case shall be kick proof type, shielding the movable part and provide a padlock strike to prevent scratching and marring the door. A lock hole cover plate shall be provided for use with padlocks.

Door Latching 1 & 2 Tier, 2 Person & Duplex: Doors to have latch clip engaging the door frame at three points on doors over 42" high and two points on all other doors. Locking device to be positive, automatic type, whereby locker door may be locked when open, then closed without unlocking. One rubber silencer shall be firmly secured in the frame at each heavy gauge latch hook. Latch clips shall be glass filled nylon for long life and low friction and shall hold doors shut by engaging the latch hooks.

Door Handle & Latching 3 to 6 Tier Box Lockers: Doors shall be punched for use with padlocks or built-in locks. Doors for use with padlocks shall be equipped with an 18 gauge combination door pull, staple and lock hole cover plate with integral friction catch.

Ventilation: Lockers with doors 36" to 72" high shall have two sets of louvers, one set near the top of the door and another set near the bottom of the door. Lockers with doors 30" or less in height, shall have a minimum of one set of louvers.

Number Plates: Each locker to be supplied with a polished aluminum number plate, 2-1/4" wide x 1" high, with black numerals not less than 3/8" high. Number plates shall be attached to the face of the door with two aluminum rivets.

Interior Equipment: Single-tier lockers 48-1/2" or higher shall have a hat shelf located approximately 9" below the top of locker; if less than 18" deep, locker shall have three single prong hooks and one double-prong ceiling hook on 9" and 12" wide lockers. Four single prong hooks are supplied on wider models. Single tier lockers 18" or more in depth shall have a coat rod instead of a ceiling hook. 30" & 36" high lockers shall have three single-prong wall hooks and one double-prong ceiling hook through 12" wide and four wall hooks for 15" or wider. 24" wide will have two double prong ceiling hooks. 20" & 24" high openings to have three wall hooks through 12" wide, and four wall hooks for 15" wide and wider. Hooks to be attached with two bolts per hook.

Locker Accessories

See locker Accessory Specifications.

Options

Body: Locker shall be assembled using rivets.
Recessed Handle 1, 2 & 3 Tier Latching: Delete the standard handle and provide handle recessed

in the door with finger lift control. 22 gauge drawn pocket shall be brushed stainless steel securely fastened to the door with two tabs plus a positive tamper resistant decorative fastener. The pocket shall be of sufficient depth to prevent a combination padlock, built-in combination lock or key lock from protruding beyond the face of the door. A lock hole cover plate shall be provided for use with padlocks.

The lifting piece shall be 14 gauge formed steel, attached to the latching channel with one concealed retaining lug and one rivet assuring a positive two point connection. Handle finger lift shall have a padlock eye for use with a 9/32" diameter padlock shackle. It shall have a sound deadening molded comfortable finger lift. Note: adding a recessed handle changes the lower louver pattern.

Hush Tone Sound-Dampening Panels: Panels are designed to reduce sound levels when doors are slammed. They are 22 gauge and are die formed and have a full perimeter flange spot welded flush to the inside door surface. Louvers are not used when sound-dampening panels are provided.

Side and Back Ventilation: Sides and/or backs shall be perforated with 1/2" diameter holes in patterns of 42 holes per group.

Door Ventilation: Visual perforations shall consist of 5/8" wide x 1-1/8" high rectangular perforations in the door in standard manufacturer's patterns. Doors with visual perforations shall not have louvers. Mini louvers shall be 5/8" wide x 1/4" high and be placed in doors in manufacturer's standard pattern. Doors with mini louvers shall not have standard louvers.

ADA Compliant Lockers: Handicap lockers shall have recessed handles and shall be single tier or the lower opening of a double tier locker. Locker bottom shall be a minimum of 15" off the floor, or an extra shelf placed 15" off the floor. Single tier lockers shall have a shelf 48" off the floor. Doors assigned for handicapped use shall have an appropriate symbol sign.

Execution:

Installation: Install metal lockers at location shown in accordance with manufacturers instructions for plumb, level, and flush installation.

Anchor Lockers to the floor and wall 36" on center or less as recommended by the manufacturer.

Install Sloping Hoods and Metal Fillers using concealed fasteners. Provide flush hairline joints against adjacent surfaces.

Install Benches by fastening bench tops to pedestals and securely anchoring to the floor using appropriate anchors for the floor material.

Adjust & Clean: Adjust doors and latches to operate without binding. Verify that latches are operating satisfactorily.

Touch Up marred finishes with factory supplied paint.

Penco Products, Inc. reserves the right to vary specifications consistent with a policy of continuous product improvement.

Specifications

Guardian™ Lockers (KD)

Materials

Sheet Steel: All parts made from prime grade mild cold rolled sheet steel free from surface imperfection, and capable of taking a high grade enamel finish.

Hinges: .074" thick, 2" high, double spun, full loop, tight pin, five-knuckle hinges, projection welded to door frame and securely fastened to the door with 2 steel rivets. Doors over 48" high and less than 24" wide shall have three hinges; smaller doors shall have two hinges. Doors 24" wide x 60" or 72" high shall have one door per opening and four hinges per door.

Finishing: Chemically pretreat metal with a multiple stage cleaning and metal preparation process. Finish coat shall be electrostatically applied powder coat enamel properly cured to paint manufacturer specifications to achieve optimum performance. All lockers shall be painted inside and outside with the same color.

Equipment: Coat hooks and coat rods are zinc plated. Truss fin head bolts and hex nuts are zinc plated.

Fabrication General

Construction: Built on the unit principle - each locker shall have an individual door and frame, individual top, bottom, back and shelves with common intermediate uprights separating compartments. Lockers shall be fabricated square, rigid and without warp. Doors shall be flat and free of distortion.

Door Frame: All door frame members to be not less than 16 gauge formed to a channel shape. Vertical members to have an additional flange to provide a continuous door strike. Intermembering parts to be mortised and tenoned and electrically welded together in a rigid assembly capable of resisting strains. Cross frame members of 16 gauge channel shapes including intermediate cross frame on double and triple tier lockers shall be securely welded to vertical framing members to ensure rigidity.

Body: Bolt spacing in locker body construction not to exceed 9" o.c. All locker body components shall be made of cold rolled steel specially formed for added strength and rigidity and to ensure tight joints at fastening points. Tops & bottoms shall be 24 gauge with three sides formed 90° and the front offset formed to be flush with the horizontal frame member. Shelves shall be 24 gauge with four sides formed to 90°, the front edge shall have a second bend. Backs & sides shall be 24 gauge.

Doors: Doors 20" or higher shall be formed from one piece 16 gauge cold rolled sheet steel. Formations shall consist of a full channel shape on the lock side of adequate depth to fully conceal the lock bar, channel formation on the hinge side, and right angle formations across the top and bottom. Doors over 15" wide x 60" or 72" high shall have a 3" wide 20 gauge full height reinforcing pan welded to the inside face of the door on 6" centers. Doors less than 12" wide shall be minimum of 18 gauge.

Door Handle & Latching: Handles shall be recessed in the door and be finger lift control. The 22 gauge drawn pocket shall be brushed

stainless steel securely fastened to the door with two tabs plus a positive tamper resistant decorative fastener. The pocket shall be of sufficient depth to prevent a combination padlock, built-in combination lock or key lock from protruding beyond the face of the door. A lock hole cover plate shall be provided for use with padlocks.

The lifting piece shall be 14 gauge formed steel, attached to the latching channel with one concealed retaining lug and one rivet assuring a positive two point connection. Handle finger lift shall have a padlock eye for use with a 9/32" diameter padlock shackle. It shall have a sound deadening molded comfortable finger lift.

Doors to have latch clip engaging the door frame at three points on 60" & 72" high and two points on 20" through 36" high doors. Locking device to be positive, automatic type, whereby locker door may be locked when open, then closed without unlocking. One rubber silencer shall be firmly secured in the frame at each heavy gauge latch hook. Latch clips shall be glass filled nylon for long life and low friction and shall hold doors shut by engaging the latch hooks.

Ventilation: Shall be facilitated by air flow slots located in the top & bottom flange of the door. The door front shall be flush with no exposed louvers.

Number Plates: Each locker to be supplied with a polished aluminum number plate, 2-1/4" wide x 1" high, with black numerals not less than 3/8" high. Number plates shall be attached to the face of the door with two aluminum rivets.

Interior Equipment: Single tier lockers 48-1/2" or higher shall have a hat shelf located approximately 9" below the top of locker; if less than 18" deep, locker shall have three single prong hooks and one double-prong ceiling hook on 9" and 12" wide lockers. Four single prong hooks are supplied on wider models. Single tier lockers 18" or more in depth shall have a coat rod instead of a ceiling hook. 30" & 36" high lockers shall have three single-prong wall hooks and one double-prong ceiling hook through 12" wide and four wall hooks for 15" or wider. 24" wide will have two double prong ceiling hooks. 20" & 24" high openings to have three wall hooks through 12" wide, and four wall hooks for 15" wide and wider. Hooks to be attached with two bolts per hook.

Locker Accessories

Lockers shall be furnished with the accessories selected from the Accessory Specifications.

Options:

Body: Lockers shall be assembled using rivets.
Doors: Guardian Plus doors shall be 14 gauge steel.

Hush Tone Sound-Dampening Panels:

Medallion Option has heavy duty panels that reduce sound levels when doors are slammed. They are 22 gauge and are die formed and have a full perimeter flange spot welded flush to the inside door surface.

Louvers are not used when sound-dampening panels are provided.

Door Ventilation: Mini louvers shall be 5/8" wide x 1/4" high and be placed in doors in manufacturer's standard pattern.

ADA Lockers: Handicap lockers shall have recessed handles and shall be single tier or the lower opening of a double tier locker. An extra shelf should be ordered to bring the lowest reach point within ADAAG guidelines and installed on site.

Relocation of the hat shelf on a single tier locker may also be necessary to comply with the prescribed reach range. Doors assigned for handicapped use shall have an appropriate symbol sign.

Execution

Installation: Install metal lockers at location shown in accordance with manufacturer's instructions for plumb, level, and flush installation.

Anchor Lockers to the floor and wall 36" on center or less as recommended by the manufacturer.

Install Sloping Hoods and Metal Fillers using concealed fasteners. Provide flush hairline joints against adjacent surfaces.

Install Benches by fastening bench tops to pedestals and securely anchoring to the floor using appropriate anchors for the floor material.

Adjust & Clean: Adjust doors and latches to operate without binding. Verify that latches are operating satisfactorily.

Touch Up marred finishes with factory supplied paint.

Penco Products, Inc. reserves the right to vary specifications consistent with a policy of continuous product improvement.

Specifications

Invincible II™ Lockers (KD)

Materials

Sheet Steel: All parts made from prime grade mild cold rolled sheet steel free from surface imperfection, and capable of taking a high grade enamel finish.

Hinges: .074" thick, 2" high, double spun, full loop, tight pin, five-knuckle hinges, projection welded to door frame and securely fastened to the door with 2 steel rivets. Doors over 48" high shall have three hinges, all other doors shall have two hinges except the 24" wide x 60" or 72" doors which shall have four hinges.

Finishing: Chemically pretreat metal with a multiple stage cleaning and metal preparation process. Finish coat shall be electrostatically applied powder coat enamel properly cured to paint manufacturer specifications to achieve optimum performance. All lockers shall be painted inside and outside with the same color.

Equipment: Coat hooks and coat rods are zinc plated. Truss fin head bolts and hex nuts are zinc plated.

Fabrication General

Construction: Built on the unit principle - each locker shall have an individual door and frame, individual top, bottom, back and shelves with common intermediate uprights separating compartments. Lockers shall be fabricated square, rigid and without warp. Doors shall be flat and free of distortion.

Door Frame: All door frame members to be not less than 16 gauge formed to a channel shape. Vertical members to have an additional flange to provide a continuous door strike. Intermembering parts to be mortised and tenoned and electrically welded together in a rigid assembly capable of resisting strains. Cross frame members of 16 gauge channel shapes including intermediate cross frame on double and triple tier lockers shall be securely welded to vertical framing members to ensure rigidity.

Body: Bolt spacing in locker body construction not to exceed 9" o.c. All locker body components shall be made of cold rolled steel specially formed for added strength and rigidity and to ensure tight joints at fastening points. Tops & bottoms shall have three sides formed 90° and the front offset formed to be flush with the horizontal frame member. Shelves shall have sides formed to 90°, the front edge shall have a second bend. Backs shall be 18 gauge; all other body parts shall be 16 gauge.

Doors: Doors 20" or higher shall be formed from one piece 14 gauge cold rolled sheet steel. Formations shall consist of a full channel shape on the lock side of adequate depth to fully conceal the lock bar, channel formation on the hinge side, and right angle formations across the top and bottom. Doors over 15" wide and over 30" high shall have a 3" wide full height 20 gauge reinforcing pan welded to the inside face of the door on 6" centers.

Doors for box lockers 4, 5, 6, 8 & 9 tiers high shall be 14 gauge steel and have channel formations on lock side and hinge side and have right angle flanges on the top and bottom.

Door Handle & Latching 1, 2 & 3 Tier: Handles shall be recessed in the door and be finger lift control. The 22 gauge drawn pocket shall be brushed stainless steel securely fastened to the door with two tabs plus a positive tamper resistant decorative fastener. The pocket shall be of sufficient depth to prevent a combination padlock, built-in combination lock or key lock from protruding beyond the face of the door. A lock hole cover plate shall be provided for use with padlocks.

The lifting piece shall be 14 gauge formed steel, attached to the latching channel with one concealed retaining lug and one rivet assuring a positive two point connection. Handle finger lift shall have a padlock eye for use with a 9/32" diameter padlock shackle. It shall have a sound deadening molded comfortable finger lift.

Doors to have latch clip engaging the door frame at three points on 60" & 72" high and two points on 20" through 36" high doors. Locking device to be positive, automatic type, whereby locker door may be locked when open, then closed without unlocking. One rubber silencer shall be firmly secured in the frame at each heavy gauge latch hook. Latch clips shall be glass filled nylon for long life and low friction and shall hold doors shut by engaging the latch hooks. Latch hooks on diamond-perforated lockers shall have tamper guards.

Door Handle & Latching 4 to 9 Tier Box Lockers:

Doors shall be punched for use with padlocks or built-in locks. Doors for use with padlocks shall be equipped with an 18 gauge combination door pull, staple and lock hole cover plate with integral friction catch.

Ventilation: All locker sides and doors 20" or higher shall be perforated with diamond-shaped openings 3/4" wide x 1-1/2" high in a quantity and pattern to insure maximum ventilation and maintain structural strength. All other doors shall have small diamond-shaped perforations 7/16" wide x 15/16" high.

Number Plates: Each locker to be supplied with a polished aluminum number plate, 2-1/4" wide x 1" high, with black numerals not less than 3/8" high. Number plates shall be attached to the face of the door with two aluminum rivets.

Interior Equipment: Single-tier lockers 48-1/2" or higher shall have a hat shelf located approximately 9" below the top of locker; if less than 18" deep, locker shall have three single prong hooks and one double-prong ceiling hook on 9" and 12" wide lockers. Four single prong hooks are supplied on wider models. Single tier lockers 18" or more in depth shall have a coat rod instead of a ceiling hook. 30" & 36" high lockers shall have three single-prong wall hooks and one double-prong ceiling hook through 12" wide and four wall hooks for 15" or wider. 24" wide will have two double prong ceiling hooks. 20" & 24" high openings to have three wall hooks through 12" wide, and four wall hooks for 15" wide and wider. Hooks to be attached with two bolts per hook.

Locker Accessories

Lockers shall be furnished with the accessories selected from the Accessory Specifications.

Options

Body: Lockers shall be assembled using rivets.
Doors: Box locker doors 4 to 9 tier, as an alternative option each door shall be furnished with a stainless steel padlock strike.

Door Handle & Latching 4 to 9 Tier Box

Lockers: As an alternate option, each door shall be provided with a finger operated 11 gauge slam latch with an electrogalvanized trigger, and a spring contained in a 14 gauge case welded to the door. The spring latch engages a 13 gauge hasp welded to the frame. Rubber bumpers shall be securely installed in the frame.

Door Ventilation: Standard louvers or mini louvers (5/8" wide x 1/4" high) may be substituted for diamond perforations in doors. All louvers and perforations shall be placed in doors according to manufacturer's standard pattern.

ADA Compliant Lockers: Handicap lockers shall have recessed handles and shall be single tier or the lower opening of a double tier locker. Locker bottom shall be a minimum of 9" off the floor, or an extra shelf placed 9" off the floor. Single tier lockers shall have a shelf 48" off the floor. Doors assigned for handicapped use shall have an appropriate symbol sign.

Execution

Installation: Install metal lockers at location shown in accordance with manufacturers instructions for plumb, level, and flush installation.

Anchor Lockers to the floor and wall 36" on center or less as recommended by the manufacturer.

Install Sloping Hoods and Metal Fillers using concealed fasteners. Provide flush hairline joints against adjacent surfaces.

Install Benches by fastening bench tops to pedestals and securely anchoring to the floor using appropriate anchors for the floor material.

Adjust & Clean: Adjust doors and latches to operate without binding. Verify that latches are operating satisfactorily.

Touch Up marred finishes with factory supplied paint.

Penco Products, Inc. reserves the right to vary specifications consistent with a policy of continuous product improvement.

Specifications

All-Welded Lockers (Welded)

Materials

Sheet Steel: All parts made from prime grade mild cold rolled sheet steel free from surface imperfection, and capable of taking a high grade enamel finish.

Finishing: Chemically pretreat metal with a multiple stage cleaning and metal preparation process. Finish coat shall be electrostatically applied powder coat enamel properly cured to paint manufacturer specifications to achieve optimum performance. All lockers shall be painted inside and outside with the same color.

Fabrication General

Construction: Fabricate lockers square, rigid and without warp. Metal faces shall be flat and free of distortion. Lockers shall be pre-assembled of welded construction, all welds shall be free of burrs. Grouping shall be the most practical that conforms to the job requirement. No bolts, nuts or rivets shall be allowed in the assembly of main locker groups. Each locker group shall be securely welded into a one piece structure.

Side and Door Frame: Shall be manufactured from 16 gauge steel. The front edge of the frame shall be formed to a channel shape with a continuous door strike. Two and three tier lockers shall have intermediate 16 gauge channel shaped horizontal frame members attached to the side frames with mortise and tenon construction, and securely welded. Intermediate frames shall consist of two 16 gauge frame channels securely welded together.

Tops: Shall be 16 gauge notched and formed. Each group of lockers shall have one continuous flat top.

Bottoms: Shall be 16 gauge notched and formed. Each group of lockers shall have one continuous bottom suitable for anchoring to wood or concrete bases.

Shelves: Shall be 16 gauge, flanged on four sides with an additional return flange on the front edge to increase strength.

Backs: Shall be solid 18 gauge cold rolled steel. One piece steel backs for groups to 48" wide. Groups over 48" wide shall have two piece backs.

Doors: Doors 20" or higher shall be formed from one piece 14 gauge cold rolled sheet steel. Formations shall consist of a full channel shape on the lock side of adequate depth to fully conceal the lock bar, channel formation on the hinge side, and right angle formations across the top and bottom. Doors over 15" wide and over 30" high shall have a 3" wide 20 gauge full height reinforcing pan welded to the inside face of the door on 6" centers.

Doors for box lockers 4, 5, 6, 8 & 9 tiers high shall be 14 gauge steel and have channel formations on lock side and hinge side and have right angle flanges on the top and bottom.

Door Handle & Latching 1, 2 & 3 Tier: Handles shall be recessed in the door and be finger lift control. The 22 gauge drawn pocket shall be brushed stainless steel securely fastened to the door with two tabs plus a positive tamper resistant decorative fastener. The pocket shall be of sufficient depth to prevent a combination

padlock, built-in combination lock or key lock from protruding beyond the face of the door. A lock hole cover plate shall be provided for use with padlocks.

The lifting piece shall be 14 gauge formed steel, attached to the latching channel with one concealed retaining lug and one rivet assuring a positive two point connection. Handle finger lift shall have a padlock eye for use with a 9/32" diameter padlock shackle. It shall have a sound deadening molded comfortable finger lift. Doors to have latch clip engaging the door frame at three points on 60" & 72" high and two points on 20" through 36" high doors. Locking device to be positive, automatic type, whereby locker door may be locked when open, then closed without unlocking. One rubber silencer shall be firmly secured in the frame at each heavy gauge latch hook. Latch clips shall be glass filled nylon for long life and low friction and shall hold doors shut by engaging the latch hooks. Latch hooks on diamond-perforated lockers shall have tamper guards.

Door Handle & Latching 4 to 9 Tier Box Lockers: Doors shall be punched for use with padlocks or built-in locks. Doors for use with padlocks shall be equipped with an 18 gauge combination door pull, staple and lock hole cover plate with integral friction catch.

Ventilation: All sides and doors 20" or higher shall be perforated with diamond-shaped openings 3/4" wide x 1-1/2" high in a quantity and pattern to insure maximum ventilation and maintain structural strength. All other doors shall have small diamond-shaped perforations 7/16" wide x 15/16" high.

Number Plates: Each locker to be supplied with a polished aluminum number plate, 2-1/4" wide x 1" high, with black numerals not less than 3/8" high. Number plates shall be attached to the face of the door with two aluminum rivets.

Hinges: 16 gauge continuous type hinge is welded to the door and riveted to the frame for the full height of the door.

Interior Equipment: Single tier lockers 48-1/2" or higher shall have one hat shelf located approximately 9" down from the top of the lockers. Lockers 20" or more in height and up to 15" wide to be supplied with one double prong ceiling hook and two single prong wall hooks, over 15" wide to be supplied with a double prong ceiling hook and four single prong wall hooks.

All coat hooks shall be forged steel with ball ends, zinc plated.

Locker Options

Continuous Metal Base: If required base shall be 4" high 16 gauge, integral with locker bottom.

Legs: If required, each group of lockers shall be furnished with four 14 gauge legs each 4" high and welded to the locker bottom.

Doors: Box locker doors 4 to 9 tier, as an alternative option each door shall be furnished with a stainless steel padlock strike.

Door Handle & Latching 4 to 9 Tier Box

Lockers: As an alternate option, each door shall be provided with a finger operated 11 gauge slam latch with an electrogalvanized trigger, and a spring contained in a 14 gauge case welded to the door. The spring latch engages a 13 gauge hasp welded to the frame. Rubber bumpers shall be securely installed in the frame.

Ventilation: If specified, all perforations may be deleted. If deleted, louvers may be added to the doors.

Door Ventilation: Delete diamond perforations in the doors and substitute with standard louvers, or mini louvers may be substituted and shall be 5/8" wide x 1/4" high. Louvers shall be placed in doors in manufacturer's standard pattern.

ADA Lockers: Handicap lockers shall have recessed handles and shall be single tier or the lower opening of a double tier locker. Locker bottom shall be a minimum of 9" off the floor, or an extra shelf placed 9" off the floor. Single tier lockers shall have a shelf 48" off the floor. Doors assigned for handicapped use shall have an appropriate symbol sign.

Accessories: For accessories see Accessory Specifications.

Execution

Installation: Install metal lockers at location shown in accordance with manufacturers instructions for plumb, level, and flush installation.

Anchor Lockers to the floor and wall 36" on center or less as recommended by the manufacturer.

Install Sloping Hoods and Metal Fillers using concealed fasteners. Provide flush hairline joints against adjacent surfaces.

Install Benches by fastening bench tops to pedestals and securely anchoring to the floor using appropriate anchors for the floor material.

Adjust & Clean: Adjust doors and latches to operate without binding. Verify that latches are operating satisfactorily.

Touch Up marred finishes with factory supplied paint.

Penco Products, Inc. reserves the right to vary specifications consistent with a policy of continuous product improvement.

Specifications

Angle Iron Lockers (Welded)

Overview

Available in 1, 2, and 6 tier models. Doors are 14 gauge. For 1 and 2 tier lockers, there is a choice between single point latch doors with stainless steel pockets, and 3-point latching with a cremone turn handle. Tops and bottoms are made of solid 16 gauge cold rolled steel. Perforated sides and perforated intermediate partitions are constructed of 14 gauge diamond perforated metal for ventilation.

Materials

Sheet Steel: All parts made from prime grade mild cold rolled steel free from surface imperfection and capable of taking a high grade pure polyester powder coat finish.

Finish: Chemically pretreat metal with a multiple stage cleaning and metal preparation process. Finish coat shall be electrostatically applied powder coat enamel properly cured to paint manufacturer specifications to achieve optimum performance. All lockers shall be painted inside and outside with the same color.

Fabrication General

Construction: Fabricate lockers square, rigid and without warp. Metal faces shall be free of distortion. Lockers shall be of welded construction and all welds shall be free of burrs. Grouping shall be the most practical that conforms to the job requirements. No bolts, nuts, or rivets shall be allowed in the assembly of main locker groups. Each locker group shall be securely welded into a one-piece structure.

Framing System: Frames shall be made of continuous 1" x 1" x 1/8" pretreated (to remove scale) angle iron steel.

Sides and Intermediate Partitions: 16 gauge solid, or 14 gauge diamond-perforated, as required.

Formed Door: 1, 2, 3 and 6 tier doors shall be constructed of solid 14 Ga. cold rolled steel with double bends on vertical sides and a single bend on horizontal sides.

Tops, Shelves: Shall be made of solid 16 Ga. cold rolled sheet steel free of surface imperfections.

Backs: 18 gauge steel in one piece for groups to 48" wide. Groups over 48" wide shall have two piece backs.

Bottoms: Shall be made of solid 16 Ga. cold rolled sheet steel with front to back 16 Ga. spacer channel welded to locker bottom [when closed bases are not used] for easier and more secure installation.

Latching Options 1, 2 & 3 Tier:

Defiant II Single Point Door (doors 20" or higher): Provide an unbreakable stationary 11 gauge latch welded to locker frame, extending no more than 1-1/4" into the locker opening. A stainless steel recessed pocket is mounted to a 14 gauge sheet steel door which is reinforced with a 3.5" wide 18 gauge full height reinforcing pan welded on four sides to the inside of the door on the hinge side. Doors measuring wider than 18" shall feature a 20 gauge, horizontal box pan MIG welded to the hinge and latch side formations, and will be spot welded to the door skin at top and bottom for optimum strength. Door latch and

recessed pocket assembly shall be capable of accepting either a padlock or built-in lock. The formed pocket shall be brushed stainless steel securely fastened to the door with two lugs plus a positive tamper resistant fastener. The pocket shall be of sufficient depth to prevent a standard combination padlock, built-in combination lock or key lock from protruding beyond the face of the door. An anti-pry lock alignment bracket shall be supplied for use with locks to facilitate installation and adjustment. A lock hole cover plate shall be provided for use with padlocks. All pockets shall be 22 gauge drawn stainless steel for superior strength. An integral door pull shall be formed in the pocket.

Locking shall be accomplished by an 11 gauge lug welded to the locker frame. The lug shall include a surface for the bolt of a built-in combination or key lock to engage. A padlock staple shall protrude through the 22 gauge pocket. The hasp assembly shall include an additional lug that mechanically engages a slot on the latch side door formation preventing the spreading of the door from the frame channel. An integral brace shall be welded to the locker side sheet to prevent rotation of the frame channel. Rubber door silencers shall be firmly attached to the locker frame.

3 Point / 3 Sided Cremone Latch: Provides an unbreakable steel handle welded securely to a 3-point cremone type latch mechanism. Latching rods 3/8" in diameter shall engage top and bottom edge of locker frame: a 1/8" thick center latch shall engage the locker jamb, enabling door to latch on three sides. Mechanism must be compatible for padlocks and built-in deadbolt locks.

Box Lockers: Doors shall be punched for use with padlocks or built-in locks. Doors for use with padlocks shall be equipped with an 18 Ga. combination door pull staple and lock-hole cover plate with integral friction catch. Doors shall be perforated with diamond shaped perforations 7/16" wide and 15/16" high.

Ventilation, Doors: Doors 20" or higher shall be perforated with diamond shaped openings 3/4" wide x 1-1/2" high. Other doors shall have small shaped perforations 7/16" wide and 15/16" high.

Number Plates: Each locker door shall be supplied with a polished aluminum number plate 2-1/4" wide x 1" high, with black numerals not less than 3/8" high. Number plates shall be attached to the face of the door with two aluminum rivets.

Hinges: 16 gauge continuous hinges (full length of the door) are welded to the door and riveted to the frame.

Interior Equipment: Single tier lockers 48-1/2" or higher shall have one hat shelf located approximately 9" down from the top of the locker. Lockers 20" or more in height and 12" or 15" wide shall have one double-prong ceiling hook and two single-prong wall hooks. Lockers over 15" wide shall have a double-prong ceiling hook and four single-prong wall hooks. All coat hooks shall be of forged steel with ball ends, zinc plated.

Locker Accessories

Locks: Built-in or padlocks.

Slope Hoods: Available in six-foot sections.

Options

Door Handle & Latching 1 & 2 Tier

(ADA Compliant): Handles shall be recessed in the door and be finger lift control. The 22 gauge drawn pocket shall be brushed stainless steel securely fastened to the door with two tabs plus a positive tamper resistant decorative fastener. The pocket shall be of sufficient depth to prevent a combination padlock, built-in combination lock or key lock from protruding beyond the face of the door. A lock hole cover plate shall be provided for use with padlocks.

The lifting piece shall be 14 gauge formed steel, attached to the latching channel with one concealed retaining lug and one rivet assuring a positive two point connection. Handle finger lift shall have a padlock eye for use with a 9/32" diameter padlock shackle. It shall have a sound deadening molded comfortable finger lift.

Doors to have latch clip engaging the door frame at three points on 60" & 72" high and two points on 20" through 36" high doors. Locking device to be positive, automatic type, whereby locker door may be locked when open, then closed without unlocking. One rubber silencer shall be firmly secured in the frame at each heavy gauge latch hook. Latch clips shall be glass filled nylon for long life and low friction and shall hold doors shut by engaging the latch hooks. Latch hooks on diamond-perforated lockers shall have tamper guards. The latch channel assembly shall be quieted by the use of unique nylon glides to reduce noise.

Hinges: Doors shall be hinged on the right side with 3" five knuckle 14 Ga. fast pin heavy-duty butt hinges. Provide three hinges on each single tier door and two hinges on each 2 through 6 tier doors. Hinges shall be welded to both door and locker frame.

Integral Base: Provide a 4" high 14 Ga. welded steel base enclosed on all four sides securely welded to locker bottom.

Ventilation

Sides: Sides and intermediate partitions are constructed with 13 Ga. 3/4" flattened expanded metal securely welded to frame at intervals not to exceed 6".

Doors: If specified, all perforations may be deleted. If deleted, louvers or mini louvers may be added to the doors.

Execution

Installation: Install metal lockers at location shown in accordance with manufacturer's instructions for plumb, level, and flush installation.

Anchor Lockers to the floor and wall 36" on center, or less as recommended by the manufacturer.

Install Sloping Hoods and Metal Fillers using concealed fasteners. Provide flush hairline joints against adjacent surfaces.

Install Benches by fastening bench tops to floor pedestals and securely anchoring to the floor using appropriate anchors for the floor material.

Lifetime Limited Warranty

Locker manufacturer shall warrant the locker for the lifetime use of the original purchaser from the date of shipment. Warranty shall include all defects in material and workmanship, excluding finish, vandalism, and improper installation.

Specifications

Stadium[®] Lockers (KD or Welded)



Materials

Sheet Steel: All parts made from prime grade mild cold rolled sheet steel free from surface imperfection, and capable of taking a high grade enamel finish.

Finishing: Chemically pre-treat metal with a multiple stage cleaning and metal preparation process. Finish coat shall be powder coat paint baked on at 350-400 degrees. Select color from manufacturer's standard colors. All lockers shall be painted inside and outside with the same color as standard.

Equipment: Coat hooks and coat rods are zinc plated. Truss fin head bolts and hex nuts are zinc coated.

Fabrication General

All-Welded

Construction: Fabricate lockers square, rigid and without warp. Metal faces shall be flat and free of distortion. Lockers shall be pre-assembled by welded construction, all welds shall be free of burrs.

Body: All locker body components shall be made of cold rolled steel specially formed for added strength and rigidity and to ensure tight joints at fastening points. Tops & bottoms shall be 16 gauge notched and formed. Bottoms have two reinforcement channels for added strength.

Sides shall be 16 gauge and backs 18 gauge.

K.D. (Knocked Down)

Construction: Lockers shall be fabricated square, rigid and without warp.

Body: Bolt spacing in locker body construction not to exceed 9" o.c. All locker body components shall be made of cold rolled steel specially formed for added strength and rigidity and to ensure tight joints at fastening points. Tops & bottoms shall be 16 gauge with three sides formed 90 degrees and the front offset formed to be flush with the horizontal frame member. Bottoms have two reinforcement channels for added strength. Shelves shall be 16 gauge with four sides formed to 90 degrees, the front edge shall have a second bend. Sides shall be 16 gauge and backs 18 gauge.

All-Welded & K.D.

Locker Frame: Locker frame members to be not less than 16 gauge formed to a channel shape. Intermembering parts to be mortised and tenoned and electrically welded together in a rigid assembly capable of resisting strains.

Ventilation: For maximum ventilation locker has an open front. Side panels are to be diamond perforated unless specified.

Number Plates: Each locker to be supplied with a polished aluminum number plate, 2-1/4" wide x 1" high, with black numerals not less than 3/8" high. Number plates to be attached to center of shelf with two aluminum rivets.

Interior Equipment: Each locker is provided with: a set of rod holders and one coat rod, two single prong hooks (to be bolted to the back panel).

Shelf: 16 gauge with four sides formed to 90 degrees, the front edge shall have a second bend.

Options

Security Box: 14 gauge lockable door with a 16 gauge side panel. The door is attached to a welded frame with a continuous hinge. The hinge is mounted to door with aluminum rivets. The door is locked with a single point latch by a padlock or built in lock. A lock hole cover plate shall be provided for use with padlocks. Security box door frame members to be not less than 16 gauge formed to a channel shape. Vertical members to have an additional flange to provide a continuous door strike. Intermembering parts to be mortised and tenoned and electrically welded together in a rigid assembly capable of resisting strains.

Footlocker: Front footlocker panel includes single point latch with padlock strike plate and mini louvers. Footlocker top has a continuous hinge. Opening and closing is quieted by rubber bumpers mounted to the contact points. Seat is strengthened with two reinforcement channels welded to bottom of seat. Two side seat supports are fastened to side panels and inserted in a support tab on the front locker panel for added strength.

Side Panel: Solid Side Panels

K.D. Body: Locker shall be assembled using rivets.

Execution

Installation: Install metal lockers at location shown in accordance with manufacturers instructions for plumb, level, and flush installation.

Anchor Lockers to the floor and wall 36" on center or less as recommended by the manufacturer.

Adjust & Clean: Adjust doors and latches to operate without binding. Verify that latches are operating satisfactorily.

Touch Up marred finishes with factory supplied paint.

Penco Products, Inc. reserves the right to vary specifications consistent with a policy of continuous product improvement.

Specifications

Patriot® Lockers (KD or Welded)

Patriot® Knockdown Build

TURNOUT Locker Models

Heavy Duty Lockers: All locker body components made of cold rolled steel specially formed for added strength and rigidity and to ensure tight joints at fastening points.

Locker Body: Sides, bottoms, tops and shelves: 16 gauge steel. Sides punched for shelf locations on nominal 12 inch centers.

Backs: Solid 18 gauge steel. One-piece through 42 inches wide; supplied as two 24 inch panels on 48 inch wide lockers.

Sides: 16 gauge sheet steel with 3/4 inch (19mm) wide by 1-1/2 inch (38mm) high diamond-shaped perforations. Optional: solid sides without ventilation.

Tops and bottoms: Three sides formed 90 degrees, the front offset formed to be flush with horizontal frame member.

Shelves: 16 gauge, full width, flanged on four sides formed to 90 degrees, front edge having a second bend to increase strength.

Face Frame: Vertical frame member to be not less than 16 gauge formed to a channel shape and hemmed to create a smooth interior edge. Intermembering parts to be mortised and tenoned and electrically welded together in a rigid assembly capable of resisting strains.

Assembly hardware for Knockdown

build: Zinc plated truss fin head bolts and hex nuts. Hole spacing in locker body construction not exceeding 9 inches (225 mm). Optional factory assembly of locker bodies using rivets.

Interior Equipment

Shelf: 16 gauge full width located approximately 12 inches (304.8 mm) below top of locker.

Hooks and coat rod: Two heavy duty 3 inch high, 7/8 inch wide 2-1/2 inch deep single-prong wall hooks and one chrome plated 1 inch diameter coat rod.

Fabrication

Fabricate lockers square, rigid, without warp, with metal faces flat and free of distortion.

Fabricate Knockdown lockers on the unit principle, each locker with individual face frame, individual top, bottom, back, and shelves, with two sides forming one complete unit. Verify dimensions and arrangement before fabrication.

Finish: Finish coat shall be electrostatically applied powder coat enamel properly cured to paint manufacturer specifications to achieve optimum performance. All lockers shall be painted inside and outside with the same color.

Powder Coat: Dry Thickness: 1 to 1.2 mils (0.025 to 0.03 mm).

Color: As selected from manufacturer's standard colors.

GEAR Locker Models

Same as above with the following substitutions and additions:

Doors: One piece 14 gauge sheet steel.

Standard Door Ventilation: 6 inch (152.4 mm) wide by 3/4 inch (19 mm) high horizontal louvers arranged two groups of six.

Optional Door Ventilation: 3/4 inch (19 mm) wide by 1-1/2 inch (38 mm) high diamond-shaped perforations, or 3/4 inch (19 mm) by 1/4 inch (6.4 mm) high security mini louvers, or solid doors

Door frames: 16 gauge formed in a channel shape with continuous vertical door strikes.

Hinges: Continuous type: 16 gauge piano hinge measuring full height of door. Welded to door and attached to locker frame using steel rivets.

Door Handles and Latching

Cremona Latching: Handle shall be a heavy duty turn handle that secures the door at three points. The top and bottom frames are engaged with 3/8 inch (9.5 mm) steel rods, and a 1/8 inch (3 mm) thick center latch engages at the side. Double door configurations shall consist of a left hinged door secured its full length by the right hinged door when latched.

Handle assembly shall be secured to door using a threaded lock nut to facilitate adjustment and removal for repair if necessary. Welded handle assemblies shall not be accepted.

Optional Single Point Latching: 24 inch wide single door only. Recessed handle with integral pull and 11 gauge steel hasp welded to locker frame.

Optional Multiple Point Latching: 24 inch wide single door only. Recess finger-lift control handle in door, positive automatic type latching, whereby locker may be locked when open, then closed without unlocking.

DUTY Locker Models

Same as Knockdown Gear model above except as noted below:

Sides: 16 gauge sheet steel, solid.

Tops and Bottoms: Three sides formed 90 degrees, the front offset formed to be flush with horizontal frame member. Tops accept a single gang duplex receptacle and are ventilated with a pattern of 1 inch x 1/8 inch slots.

Interior Equipment

Shelf: 16 gauge full width, located approximately 12 inches (304.8 mm) below top of locker and perforated to promote movement of air.

Interior Divider: 16 gauge, with lockable compartment and additional side shelf.

Optional Drawer Base: Fully welded 14 gauge case with 16 gauge welded drawer insert and supported by ball bearing glides. Sides lanced to accept vertical dividers. Adds 18 inches to locker height when so equipped.

Patriot® All-Welded Build

TURNOUT Locker Models

Same as Knockdown Turnout model above except as noted below:

Fabrication

Lockers shall be pre-assembled of welded construction; all welds shall be free of burrs. No bolts, nuts or rivets shall be allowed in the assembly of main locker groups. Each locker group shall be securely welded into a one-piece structure.

Face Frame: 16 gauge formed in a channel shape with hemmed edge and integral with locker side.

Top: 16 gauge, integral with top horizontal face frame.

Channel Base: Notched and formed sheet suitable for anchoring to wood or concrete bases. Integral with locker bottom; adds 4 inches to the overall height of locker.

GEAR Locker Models

Same as Knockdown Gear lockers above with the following substitutions and additions:

Fabrication

Lockers shall be pre-assembled of welded construction; all welds shall be free of burrs. No bolts, nuts or rivets shall be allowed in the assembly of main locker groups. Each locker group shall be securely welded into a one piece structure.

Door frames: 16 gauge formed in a channel shape with continuous vertical door strikes and integral with locker side.

Top: 16 gauge, integral with top horizontal door frame. Channel Base: Notched and formed sheet suitable for anchoring to wood or concrete bases. Integral with locker bottom; adds 4 inches to the overall height of locker.

DUTY Locker Models

Same as Patriot Duty Knockdown except as noted below:

Fabrication

Lockers shall be pre-assembled of welded construction; all welds shall be free of burrs. No bolts, nuts or rivets shall be allowed in the assembly of main locker groups. Each locker group shall be securely welded into a one-piece structure.

Shelf: 16 gauge full width, located approximately 12 inches (304.8 mm) below top of locker and perforated to promote movement of air.

Interior Divider: 16 gauge, with lockable compartment and additional side shelf

Door Frames: 16 gauge, formed in a channel shape with continuous vertical door strikes and integral with locker side.

Tops: 16 gauge, integral with top horizontal door frame. Tops accept a single gang duplex receptacle and are ventilated with a pattern of 1 inch x 1/8 inch slots.

Optional Bases: Channel Base: Notched and formed sheet, suitable for anchoring to wood or concrete bases that adds 4 inches to locker height when so equipped, or **Drawer Base:** Fully welded 14 gauge case with 16 gauge welded drawer insert and supported by ball bearing glides. Sides lanced to accept vertical dividers. Adds 18 inches to locker height when so equipped.

Penco Products, Inc. reserves the right to vary specifications consistent with a policy of continuous product improvement.

Specifications

Defiant™ II Single Point Latch (SPL)

When specifying Guardian, All-Welded, Invincible II, Angle Iron or Patriot® lockers with Defiant II Single Point Latch doors, substitute the following specifications for the “Door Handle & Latching ...” section referring to 1-tier to 3-tier doors.

Doors: All doors shall be formed from 14 gauge steel. Formations shall be channel shape on the hinge and latch sides, and right angle formations across the top and bottom. Top and bottom flanges shall have one 90 degree bend. The latch side formation shall include a slot to fully engage an additional anti-pry lug integral with the padlock hasp limiting motion in any direction. On doors measuring 12” through 18” wide, additional reinforcement shall be in the form of a vertical 18 gauge pan measuring 3-1/2” wide MIG-welded to the top and bottom flanges and hinge side channel, with an additional 1/2” flange spot welded a maximum of 8” on center to the door skin to maximize door rigidity. Doors measuring more than 18” wide shall be reinforced using a 20 gauge horizontal box pan MIG-welded a maximum of 8” on center to the hinge and latch side channels, and spot welded to the door skin a maximum of 8” on center along the upper and lower pan edge for optimum strength, quiet operation and stiffness. Door shall be manufactured to allow ventilation and stiffness.

Hinge: 16 gauge continuous hinges (full length of the door) are welded to the door and riveted to the frame.

Door Handle & Latching 1, 2 & 3 Tier: Handles shall be recessed in the door. The formed pocket shall be brushed stainless steel securely fastened to the door with two lugs plus a positive tamper resistant fastener. The pocket shall be of sufficient depth to prevent a combination padlock, built-in combination lock or key lock from protruding beyond the face of the door. An anti-pry lock alignment bracket shall be supplied for use with built-in combination locks to facilitate installation, adjustment and to increase resistance to prying by mechanically engaging the hasp assembly. A lock hole cover plate shall be provided for use with padlocks.

All pockets shall be 22 gauge drawn stainless steel for superior strength. Door pull shall be formed in the pocket. Pocket and pull shall be integral. Doors shall have a catch to retain unlocked doors in the closed position. Locking shall be accomplished by an 11 gauge lug welded to the locker frame. The lug shall include a surface for the bolt of a built-in combination or key lock to engage. A padlock staple shall protrude through the 22 gauge pocket. The hasp assembly shall include an additional lug that mechanically engages a slot on the latch side door formation preventing the spreading of the door from the frame channel. A separate bracket shall be field installed to brace the lock hasp assembly against the locker side to prevent twisting of the frame. Rubber door silencers shall be firmly attached to the locker frame.

Penco Products, Inc. reserves the right to vary specifications consistent with a policy of continuous product improvement.

The Single Point Alternative

- Greater tamper resistance
- Increased rigidity
- Improved Performance with built-in locks

The Defiant II Single Point Latch (SPL) option is for those desiring a heavy gauge door offering improved security with the low maintenance inherent in a door with no moving parts.



Each door has a patented deep drawn stainless steel pocket handle with an integral door pull. The doors can be locked with a conventional padlock, using the padlock staple protruding through the recessed handle (recommended) or with a built-in lock.

Doors are stiffened with either a vertical or horizontal pan, as shown at the right.

Doors that have any type of perforations including louvers will require the perforations/ louvers to be modified from the standard patterns and sizes to allow for either type of pan to be used. Contact a Penco representative for details.



For KD Lockers



For Welded Lockers



Vertical Pan



Horizontal Pan

Anti-Pry/Lock Alignment Bracket

Defeats prying attempts by capturing the door flange and preventing separation from the door channel.



Side Stiffener

This full-depth stiffener prevents frame channel and side-sheet torquing during break-in attempts. For use at left ends of 24 gauge Guardian K.D. bodies of 1 & 2 tier lockers with combination locks only.



Defiant II 1-tier lockers with built-in combination locks, finished end panels and custom flat tops.



Defiant II 2-tier All-Welded lockers with slope hoods, finished end panels and custom bases & benches.

Specifications

Steel Locker Accessories

Closed Bases: Provide 18 gauge closed metal front and end bases on knocked down lockers having legs. Front bases shall be installed between legs without overlap or exposed fasteners. Provide end bases on exposed ends. Bases shall be finished to match lockers.

Locks: (Specify lock brand if desired, location and locker type if appropriate.) All locks shall have bolt types appropriate to the mode of locker operations.

Built-In Flat Key Locks: Lockers shall be equipped with built-in flat key type locks. All locks shall be master keyed to the same series. Provide two (2) keys for each lock and two (2) master keys for the system.

Built-In Grooved Key Locks (Pin Tumbler): Lockers shall be equipped with built-in grooved key type locks. All locks shall be master keyed to the same series. Provide two (2) keys for each lock and two (2) master keys for the system.

Built-in Combination Locks: Lockers shall be equipped with built-in combination locks. Locks shall have three-number combination dialing and be capable of at least five different combination changes. Master key, combination change key, if required, and combination control charts shall be provided to the owner.

Padlocks-Combination Type: Master keyed combination type padlocks shall be provided for all locker doors. Locks shall have three-number combination dialing. Master key shall be provided to the owner.

Coin Operated Locks: (Certain locker types and sizes will not accept coin locks; verify with locker manufacturer). Coin operated locks shall be provided for lockers.

Locks shall be (select one): Coin return/deposit type; Coin collect/pay type; Card Lock. Coin fee shall be (select one): Token; One (1) Quarter; Two (2) Quarters; Card Lock.

Locks are to be installed on lockers using security-type machine screws.

Visual Perforation 16 Ga. & 18 Ga.: Locker doors shall be provided with 5/8" x 1-1/8" rectangular visual perforations.

Round Perforation: 24 gauge (Backs, Sides, Tops, Bottoms or Shelves) are to be punched with 1/2" diameter perforations grouped in 42 hole patterns. (For sides and backs, specify full perforations for maximum number of holes in the part, or standard perforations consisting of one group top and bottom in single-tier; one group each compartment in double-tier or box lockers).

Fire Extinguisher Door: Lockers designated on drawings to contain fire extinguisher shall be double tier type with upper door to have a glazed opening. Locks are to be omitted on fire extinguisher doors.

Waste Bin Doors: Lockers designated on drawings to contain waste bins shall be provided with a door cut-out with a top hinged internal flap door over the cut-out. Locks are to be omitted on waste bin doors.

Center Partitions: Lockers shall have 24 gauge, full depth, vertical partitions between bottom and shelf.

Recess Trim: Vertical and/or horizontal recessed trim shall be provided where shown. Trim shall be formed from 18 gauge sheet steel and have a 3" face dimension. Trim shall be furnished in standard lengths as long as practical and attached to lockers with concealed clips. Finish caps and splices shall be provided as required. Trim shall be finished to match lockers.

Zee Bases: Knocked down lockers shall be furnished with 4" high or 6" high 14 gauge zee base flanged outward at top for support of lockers and inward at bottom for anchoring to the floor. Not for use for Stadium and Welded Lockers.

Front Filler: Fillers for spaces between lockers or between lockers and a wall shall be fabricated from 20 gauge sheet steel and formed in an angle shape. Slip joint angles shall be 20 gauge sheet steel formed in an angle shape with a slot on one leg to form a pocket which provides adjustable mating with the angle filler. Attachment shall be by means of concealed fasteners. Fillers shall be finished to match lockers.

Exposed Locker Sides: Shall be furnished in 16 gauge without any extra holes.

Finished End Panels: Finished end panels shall be installed on all exposed ends of lockers. They shall be formed from minimum 16 gauge sheet steel to match locker depth and height, and shall have a 1" edge dimension. All panels shall be installed with concealed fasteners. Panels shall be finished to match lockers.

Continuous Slope Hood: Lockers shall be provided with continuous slope hoods formed from 18 gauge sheet steel with a slope that has a rise equal to 1/3 of the locker depth (18-1/2"), plus a 1" vertical rise at the front. Tops shall be provided in lengths as long as practical. Provide slip joints without visible fasteners at splice locations.

Necessary end closures shall be provided. Tops shall be finished to match lockers.

Unit Slope Tops Vanguard and Guardian Lockers:

Lockers shall be provided with 24 gauge individual sloping tops. Tops shall be formed to a slope which rises 1/3 of the locker depth. Tops shall be finished to match lockers.

Benches: Locker benches shall be laminated selected hardwood, 1-1/4" full finished thickness. All corners are to be rounded and sanded. Surfaces shall be finished with two coats of clear lacquer. Bench tops are to be 9-1/2" wide and furnished in lengths of 3' through 12' (even foot increments).

Heavy Duty Bench Pedestal: Pedestals shall consist of steel tubing with 10 gauge steel flanges welded to each end. The overall height of pedestal shall be 16-1/4". Pedestals are to be finished to match the lockers.

Stainless Steel Free Standing Bench

Pedestal: Shall be 2" diameter brushed 16 ga. stainless steel formed into a trapezoid. Bottom shall be 14" wide with two 5/16" diameter holes. Pedestal shall be 16-1/4" high for an overall bench height of 17-1/2". Top flange shall have four 5/16" diameter holes for fastening to the bench. Bench can be moveable or may be anchored.

Wire Basket Racks

Shelving: Shelving units shall consist of 1" x 1" x 13 gauge angle posts punched for bolting shelves. Sway braces of 12 gauge steel shall be provided for the back and sides of the unit. Shelves shall be 20 gauge formed with downturned flanges at the back to act as a backstops.

Dividers: Dividers shall be 20 gauge, 3" in height with an attaching flange formed at right angles. Dividers are bolted to shelves.

Padlock Attachment: A padlock staple attachment shall be provided at the front edge of each shelf located to match the locking loop formed in the basket rim.

Casters (option): Mobility casters shall be 3" diameter, swivel-type bolted to each corner post.

Number Plates: Numbering shall consist of Penco standard aluminum number plates pop riveted to shelf face at each basket opening, and on the front of the basket.

Baskets: Baskets shall be (select size) 12" x 13" x 8" or 9" x 13" x 8" of (select type) all wire or wire mesh or perforated steel front type.

Pilfer Guards (option): Provide a sheet steel pilfer guard designed for field attachment to the top of the basket to cover the first 3" of depth.

Finish: Finish on baskets and pilfer guards consists of electroplating with bright zinc chromate. Basket rack posts, shelves and braces to be finished in color selected from manufacturer's standard colors.

Penco Products, Inc. reserves the right to vary specifications consistent with a policy of continuous product improvement.



Americans with Disabilities Act Information (ADA)



Penco lockers commonly accepted for ADA or barrier-free assignments are single tier and double-tier (lower tier only) when equipped with the Classic III recessed handle with multi-point latching: Vanguard, Guardian, Invincible II, All-Welded and Angle Iron (with available modifications). Other handle types and certain lock selections may not be recognized as ADA compliant without modification.

Single tier 60" or 72" high lockers with the Classic III recessed multi-point latch handles must have shelves relocated and/or added to accommodate ADAAG mandated reach ranges. Two tier 36" high openings with the Classic III recessed handle may be used by designating the lower tier for ADA compliance. An extra shelf should be ordered to bring the lowest reach point within the prescribed ADAAG range based upon side or forward reach. We recommend field drilling for these shelf locations on smaller requirements. The owner or architect may also require a handicapped access sign be placed on the door.

Other handles and configurations may sometimes be specified, but those above are the most appropriate based upon a literal interpretation. Attention should also be paid to the clear area in front of the lockers to meet other separate but related guidelines. Contact your factory representative for assistance, or go to www.access-board.gov for a complete text of the ADA Accessibility guidelines.



ADA locker can optionally be marked with a decal.



ADA locker has shelf at least 9 inches from floor.

Environmental Information

- Based upon the most recent information from our source mills, the recycled content of our steel lockers can range from 25% to over 50%. Because the percentage of recycled content may vary from project to project based on a number of variables, please contact our offices for detailed information on your specific requirement.
- Powder coating drastically reduces waste through high efficiency application & recovery methods.
- Penco's powder coat paint contains no solvents and as a result releases no Volatile Organic Compounds (VOC's) normally associated with wet paint processes.
- Our packaging contain at least 20% post-consumer recycled content.
- Approximately 34% of the U.S. population lives within a 500 mile radius of our manufacturing facility, requiring less fuel to ship our products to many destinations.



Made in USA

Penco Products, Inc. continues to manufacture every locker featured in this catalog in the United States. We believe that by capitalizing on the efficiency of our North Carolina plant as well as our experienced workforce and formidable buying power, we can remain the industry leader from right here at home.

With 475,000 square feet of manufacturing space and over 150,000 square feet at multiple QuickShip distribution centers throughout the United States, Penco is also able to deliver the industry's shortest lead times while reducing shipping time and mileage. This is the result of one company's ongoing commitment to delivering America's best storage solutions to both domestic and global marketplaces.



Color Chart

24 Designer Colors



NOTE: Colors shown are as close to actual finishes as the printing process allows. Do not make your final color selection based on the color shade shown on this page. Penco Color Charts are available for a more accurate color match. Exposure to high humidity, chlorine salts, abrasive cleaners, germicidal cleaners and acids can damage the finish and will void the guarantee. For outdoor applications or other harsh environmental conditions, contact your Penco Representative.

Standard Colors

To assure rust resistance and paint adhesion, all Penco steel products receive a state of the art pre-paint conditioning that includes a thorough cleansing by a hot spray washing process, then a specially formulated coating is applied creating a surface that resists corrosion and improves paint adhesion. Virtually all steel products are available in the 24 colors shown above.

All Penco locker doors, frames and body parts are painted the same color, as standard. Two-tone color combinations are also available at no extra charge. Contact your Penco sales representative for complete information.



Standard Powder Coat Finish

Penco's standard 1 mil thick paint finish is perfect for most applications. The paint surface is tough and durable and offers a beautiful drip-free surface, excellent edge coverage and environmentally friendly application.

PowderCoatPlus™

PowderCoatPlus is an optional cost-effective way of improving the durability and rust resistance of steel lockers. After a specialized cleaning and pre-treatment of the steel, a 2 mil thick coating of powder coat enamel is applied and baked onto the steel surface.

X-Off™ Anti-Graffiti Paint

Penco's optional X-Off Anti-Graffiti Paint for lockers provides a surface coating that allows easy removal of graffiti with alcohol and water. This specially formulated paint has a tight molecular structure that completely seals the locker surface, preventing graffiti and corrosive agents from penetrating the finish.



Supplies needed:
99% isopropyl alcohol, water, cleaning cloths, eye and hand protection.



Locker Installations



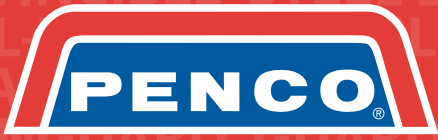

www.pencoproducts.com



Every customer's first choice to transform space into safe, secure and effective storage.

Your source for quality steel storage products and more!



Lockers



Multi-Level & High Rise Shelving



Shop Furniture & Cabinets



RivetRite® Shelving



Bleachers & Team Benches



Pallet Racks



Wide Span Shelving



Garment Lockers • Hygiene Products



Textile Rental Industry Products



Work Platforms & Safety Products



This catalog was printed on paper made in the USA.



© Copyright 2014 Penco Products, Inc. LockerCatalog7-2014.indd/pdf