



FLOOR GRIDS & MATS



BALCO INC

www.balcousa.com



FLOOR GRIDS AND MATS

- Shallow and Deep Pit Grids
- Roll Up Mats
- Solid Bronze

Balcou's versatile series of floor grid and floor mat systems gives the design flexibility you need to create impressive entrances.

The classic FG series, perfect for high profile projects, is available in both shallow grid or deep pit grid, which utilizes an attractive tread bar system bolted into rugged U channels. Dirt and moisture collect underneath the surface to keep floors clean and reduce maintenance, and rails can be replaced without dismantling the entire grid system.

If an easy-to-roll design is critical, Balcou's recessed and surface roll-up mats are a great choice for either new construction or after market applications. Our premium floor mat features vinyl hinges; the FM2 series is sturdy all-aluminum.

Both grid and mat products are also available in sophisticated solid bronze.

FG - FLOOR GRID

Balcou's "Top of the Line" Shallow Pit Floor Grid System - Standard Mill Finish Aluminum; Clear Anodized & Medium Bronze Anodized Finishes Available.

FG-1 1/2

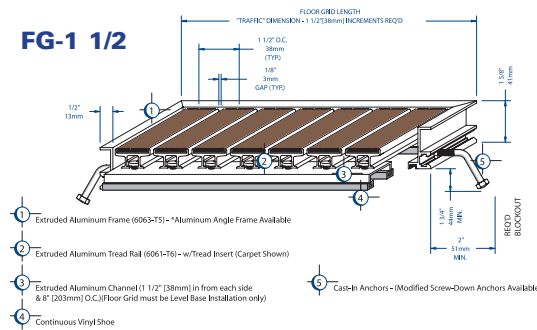

FGLP - LOW PROFILE FLOOR GRID

Low profile roll-up grid handles heavy rolling loads and is available with carpet, vinyl or abrasive inserts.

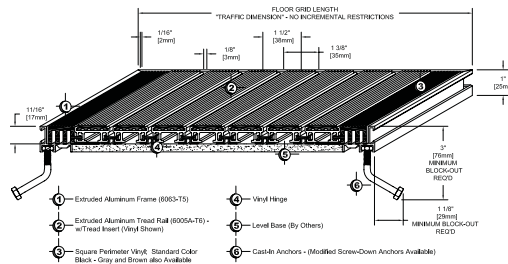

FGDP - DEEP PIT FLOOR GRID

Balcou's Deep Pit Floor Grid System is Available With or Without Collector Pan. Standard Mill Finish Aluminum; Clear Anodized, Medium Bronze Anodized Finish Available; Bronze Deep Pit also Available.

FGDP-1 1/2

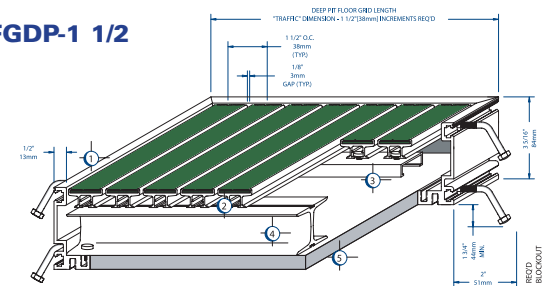

FGDP-1 1/2 with PAN ADAPTER

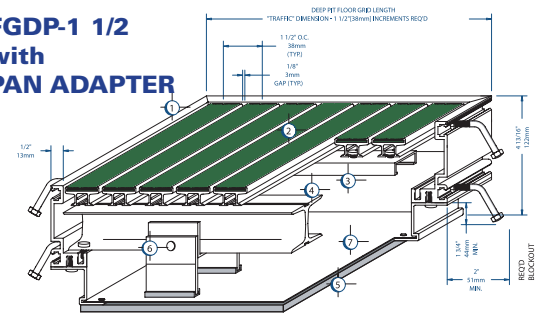

BFG - BRONZE FLOOR GRID

Prestigious Solid Architectural Bronze Shallow Pit Grid System; Standard Satin Finish with Clear Acrylic on Exposed Areas.

BFG-1 1/2S

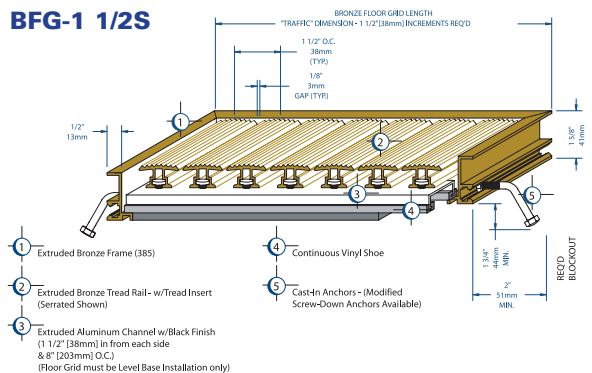

ULTRAGRID

Balcou's Level Base Entrance Grating is Available in Solid Architectural Bronze (BMR) or Aluminum (AMR); Bronze is Satin Finish in Clear Acrylic on Exposed Areas. Aluminum is Standard Mill Finish; Clear Anodized, Gold Anodized and Medium Bronze Anodized Finishes Available.

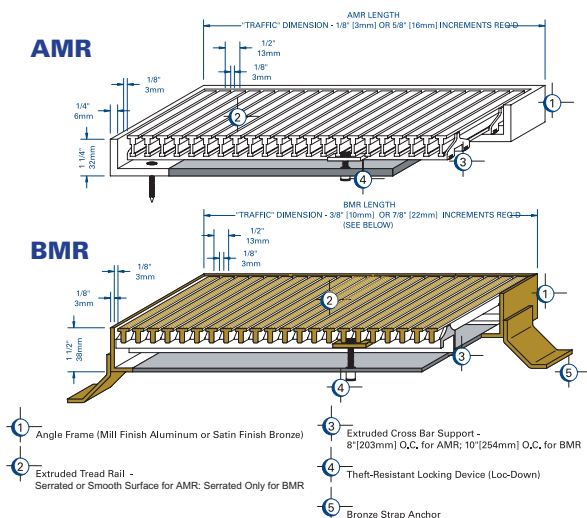

GRID TREAD OPTIONS

Options Available for FG

Carpet

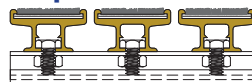

Abrasive



Vinyl

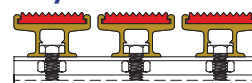

Serrated



Due to size and weight limitations, product may be shipped in multiple sections. Maximum: length 12' x 4' (10' max for abrasives), or, weight 150 pounds.

FG is a perfect solution for areas where custom shapes are required.

Download CADs and PDFs at www.balcousa.com



FM - FLOOR MAT

Balco's Premium Roll-Up Mat is a Vinyl Hinge Construction with Standard Mill Finish Aluminum; Clear Anodized & Medium Bronze Anodized Finishes Available.

FMS-V - Surface Mat

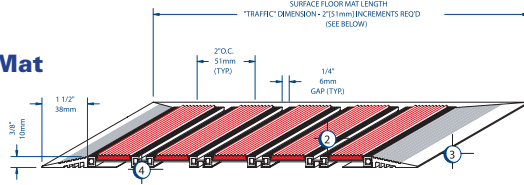

FMR-V - Recessed Mat

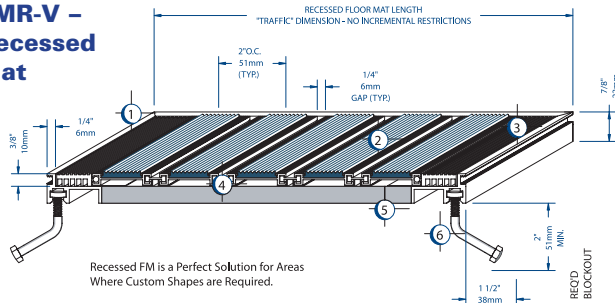

- 1 Extruded Aluminum Frame (6063-T5) - See Options Opposite Page
- 2 Extruded Aluminum Tread Rail (6063-T5) - w/Tread Insert (Vinyl Shown)
- 3 Perimeter Vinyl - Tapered for Surface Mat and Square for Recessed Mat; Standard Color Black - Gray and Brown also Available
- 4 Vinyl Hinge
- 5 Level Base (By Others)
- 6 Cast-In Anchors - (Modified Screw-Down Anchors Available)

FM2 - FLOOR MAT

All-Aluminum Construction Roll-Up Mat - Standard Mill Finish Aluminum; Clear Anodized & Medium Bronze Anodized Finishes Available.

FM2S-V - Surface Mat

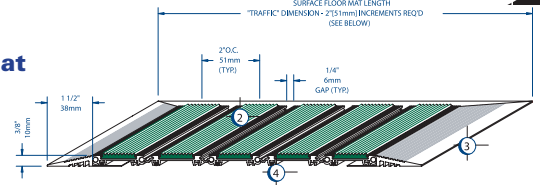

FM2R-V - Recessed Mat

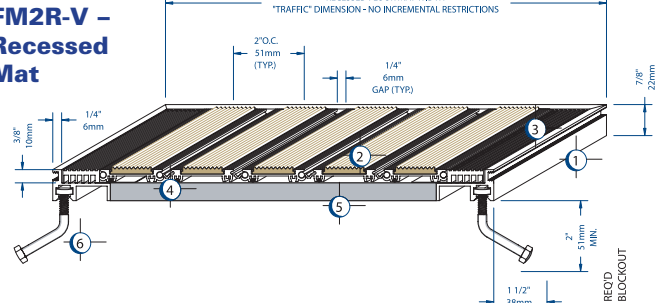

- 1 Extruded Aluminum Frame (6063-T5) - See Options Opposite Page
- 2 Extruded Aluminum Interlocking Tread Rail (6063-T5) - w/Tread Insert (Vinyl Shown)
- 3 Perimeter Vinyl - Tapered for Surface Mat and Square for Recessed Mat; Standard Color Black - Gray and Brown also Available
- 4 'No Slip' Vinyl Spline
- 5 Level Base (By Others)
- 6 Cast-In Anchors - (Modified Screw-Down Anchors Available)

FRAME OPTIONS



BFM - BRONZE FLOOR MAT

Balco's Premium Roll-Up Mat is Solid Architectural Bronze; Standard Satin Finish with Clear Acrylic on Exposed Areas.

BFMS-V - Surface Mat

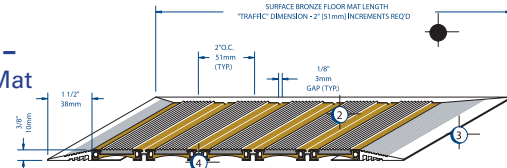

Surface Floor Mat (Only) Traffic Dimensions - Use Following Increments

- 0'0\" - 1'
- 0'0\" - 3'
- 0'0\" - 5'

RECESSED BRONZE FLOOR MAT LENGTH
"TRAFFIC" DIMENSION - NO SIZE LIMITATION

BFMR-V - Recessed Mat

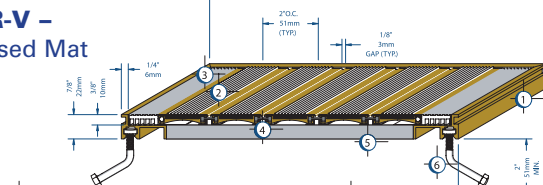

- 1 Extruded Bronze Frame (385)
- 2 Extruded Bronze Tread Rail - w/Tread Insert (Vinyl Shown)
- 3 Perimeter Vinyl - Tapered for Surface Mat and Square for Recessed Mat; Standard Color Black - Gray and Brown also Available
- 4 Vinyl Hinge
- 5 Level Base (By Others)
- 6 Cast-In Anchors (Modified Screw-down Anchors Available)

Due to Weight Limitations some Grids and Mats will be shipped in Multiple Sections

MAT TREAD OPTIONS

Options Available for FM Recessed and Surface

Carpet



Abrasive



Vinyl



Serrated*



*Not available in bronze
Due to size and weight limitations, product may be shipped in multiple sections.

Maximum: length 12' x 4' (10' max for abrasives), or, weight 150 pounds.

carpet color selections

Heavy Duty

- Forest Floor (green)
- Blue Sapphire (blue)
- Imperial Topaz (tan)
- Gray Quartz (gray)
- Black Onyx (black)
- Coffee Bean (brown)

Standard

- Cornflower (blue)
- Chrome (light gray)
- Midnight (black)
- Pewter (dark gray)
- Eggplant (deep purple)
- Mushroom (brown)
- Bordeaux (mauve)

abrasive color selections

- Earth Brown
- Red Wood
- Black
- Yellow*

*Not available in abrasive floor mats

When specifying a color, please request an actual sample from the factory

vinyl color selections

- Blue
- Beige
- Brown
- Black
- Red
- Green
- Gray

Download CADs and PDFs at www.balcousa.com

THE SENTRY™ SYSTEM

Description and Data Sheet

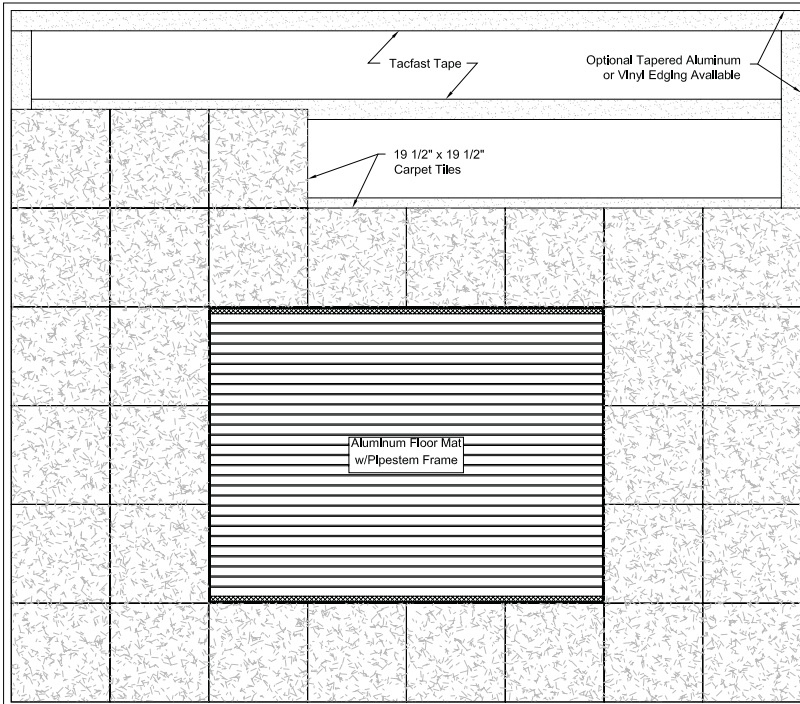

- Reduces Slips & Falls
- Removes Dirt, Debris & Moisture
- Improves Entrance Appearance
- Surface Mounted, Recessed look
- Limited 3-Year Warranty



Material

The Sentry™ System combines our Vinyl Hinge Roll up mat with wear-resistant carpet tiles to form a highly effective system for dirt removal at your entrances.

Properties

When configured according to specs, this System can trap up to 90% of the dirt and protect your floors and carpets.

Size Availability

The Sentry System can be installed to fit any entrance space.

TacFast® Backing

TacFast® utilizes an innovative hook-and-loop technology that allows carpet tiles to be removed and replaced or repositioned for maximum life.

Environmentally Safe

With TacFast® backing, there is no need for adhesives, therefore eliminating short-term volatile organic emissions (VOC) and improving indoor air quality.

Usage Areas

Recessed or surface mounted entrance systems in high traffic environments, including retail, commercial and institutional entrances.

Warranty

3-year Limited Warranty

Colors / Profiles

Call factory

Quality products engineered and crafted to meet tomorrow's needs today... Over 50 years in the business is proof that we stand behind those words. Balco has set an industry benchmark with our combination of highly skilled engineers, manufacturing processes, and drafting designs. We customize our products to fit your projects' needs. At Balco, we're dedicated to bringing you the highest quality products at competitive prices. Let us be an integral part of your next project.

Other BALCO Products

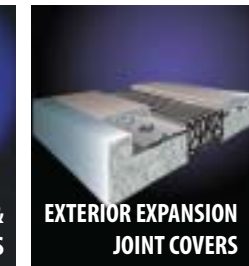
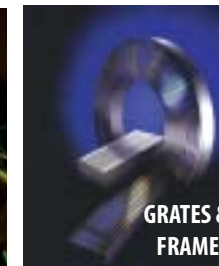
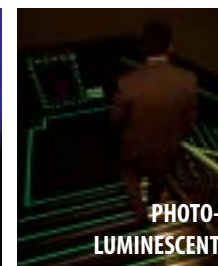

BALCO INC

2626 S. Sheridan • Wichita, KS 67217
Ph: 316.945.9328 • Fx: 316.945.0789

1.800.767.0082
www.balcousa.com



Bal Sweet FGM/ 0607©