

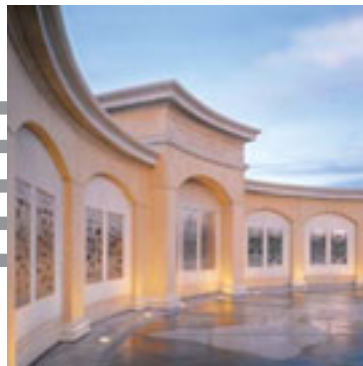

07 95 00/BAL  
BuyLine 3112

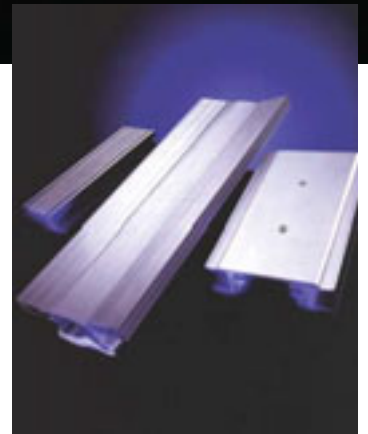

# EXPANSION JOINT COVERS

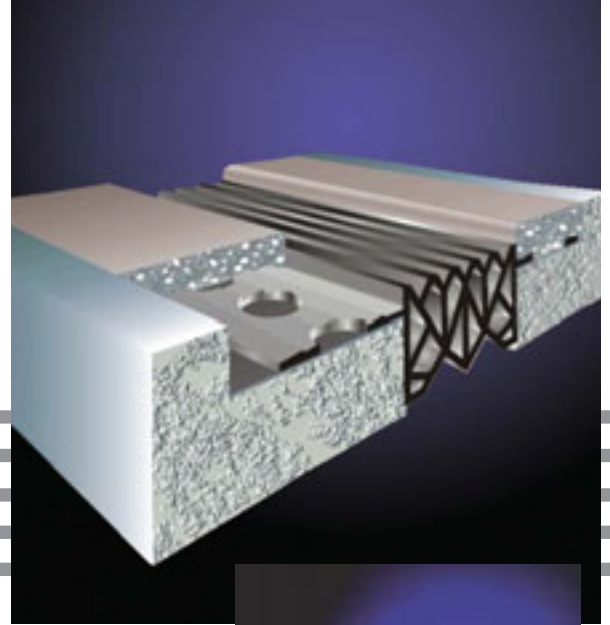

**BALCO INC**

[www.balcousa.com](http://www.balcousa.com)

## INTERIOR FLAT SEAL

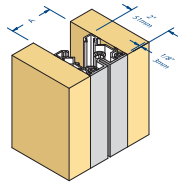

**TCWW**  
(2" - 6" joints)  
(51mm - 152mm)

### Flat & Variable Seal Series

Type	A
TCWW/FCWW	2" (51mm) to 18" (457mm)

## EXTERIOR FLAT SEAL

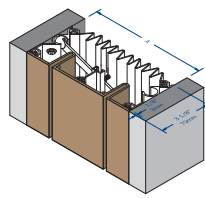

**FCWW**  
(7" - 10" joints)  
(178mm - 254mm)

Available as 2 Hour Rated System - Balco Fire Barrier Systems are Tested in Accordance with ASTM E 1966 and are Listed with Omega Point Laboratories, Inc. (Contact Balco for Additional Fire Ratings)

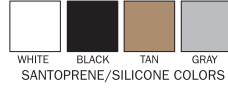

Movement Capabilities - 100% and 50%

## 7500 ELASTOMERIC FLOOR COVERS

### 75FP

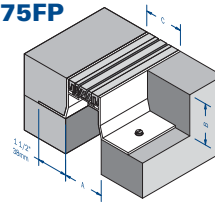

### SURFACE OPTIONS

In Addition to Plain, 7500 Series Floor Covers are also Available with a Carpet Recess or an Adaptation for 1/8" (3mm) Tile.

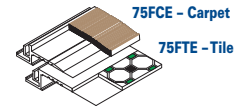

### Elastomeric Floor Series

Type	A	B	C
75FP-1X1	1" (25mm)	1" (25mm)	1 1/16" (27mm)
75FP-1X1 1/2	1" (25mm)	1 1/2" (38mm)	1 1/16" (27mm)
75FP-1X2	1" (25mm)	2" (51mm)	1 1/16" (27mm)
75FP-2X1	2" (51mm)	1" (25mm)	1 7/8" (48mm)
75FP-2X1 1/2	2" (51mm)	1 1/2" (38mm)	1 7/8" (48mm)
75FP-2X2	2" (51mm)	2" (51mm)	1 7/8" (48mm)
75FVP-1X1	1" (25mm)	1" (25mm)	1" (25mm)
75FVP-1X1 1/2	1" (25mm)	1 1/2" (38mm)	1 1/16" (27mm)
75FVP-1X2	1" (25mm)	2" (51mm)	1 1/16" (27mm)
75FVP-2X1	2" (51mm)	1" (25mm)	1 15/16" (49mm)
75FVP-2X1 1/2	2" (51mm)	1 1/2" (38mm)	1 15/16" (49mm)
75FVP-2X2	2" (51mm)	2" (51mm)	1 15/16" (49mm)

Type	A	B	C
75FPE-1	1" (25mm)	13/16" (21mm)	3 13/16" (97mm)
75FPE-2	2" (51mm)	1 5/8" (41mm)	4 5/8" (117mm)
75FVPE-1	1" (25mm)	13/16" (21mm)	2 3/8" (60mm)
75FVPE-2	2" (51mm)	1 5/8" (41mm)	3 5/16" (84mm)

7500 Series Available in 1" (25mm) and 2" (51mm) Joint Sizes Only

## 6000 SERIES INTERIOR WALL & CEILING COVERS

### 6GW

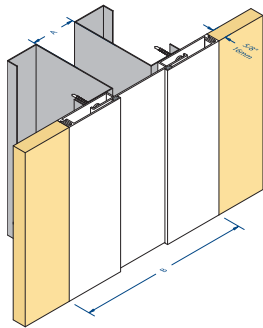

### 6000 Wall and Ceiling Series

Type	A	B	Movement
6GW-1/6TW-1	1" (25mm)	4 3/4" (121mm)	+/- 1" (25mm)
6GW-1-2/6TW-1-2	2" (51mm)	5 3/4" (146mm)	+/- 1" (25mm)
6GW-2/6TW-2	2" (51mm)	7 3/4" (197mm)	+/- 2" (51mm)
6GW-3/6TW-3	3" (76mm)	11 1/4" (286mm)	+/- 3" (76mm)
6GW-4/6TW-4	4" (102mm)	14 1/8" (359mm)	+/- 4" (102mm)
6GW-3-6/6TW-3-6	6" (152mm)	14 1/4" (362mm)	+/- 3" (76mm)
6GW-4-8/6TW-4-8	8" (203mm)	18 1/8" (460mm)	+/- 4" (102mm)



Available as 2 Hour Rated System - Balco Fire Barrier Systems are Tested in Accordance with ASTM E 1966 and are Listed with Omega Point Laboratories, Inc. (Contact Balco for Additional Fire Ratings)

## 7500 ELASTOMERIC INTERIOR WALL & CEILING COVERS

### 75FWG

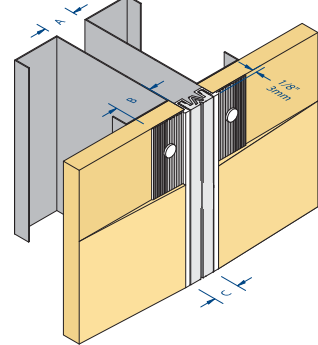

### 7500 Wall/Ceiling Series

Type	A	B	C
75FWG-1	1" (25mm)	1 3/16" (30mm)	13/16" (21mm)
75FWG-2	2" (51mm)	1 1/16" (27mm)	1 5/8" (41mm)
75FWGC-1	1" (25mm)	1 3/16" (30mm)	13/16" (21mm)
75FWGC-2	2" (51mm)	1 1/16" (27mm)	1 5/8" (41mm)

7500 Series Available in 1" (25mm) and 2" (51mm) Joint Size Only

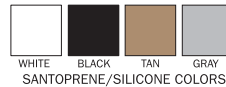

## 9500 DUAL ELASTOMERIC FLOOR COVERS

9500 Series Floor Covers are Available with 1/8" (3mm) Tile Recess, Plain Cover Plates; Specify 95FT/FVT/GFT/GFVT for Tile Recess, 95FP/FVP/GFP/GFVP for Plain Cover Plate.

### 95FT

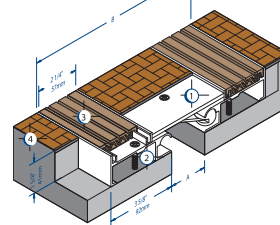

- Aluminum Center Plate with Centering Bar - Standard Mill Finish (Floor Finish By Others)
- Extruded Aluminum Sub-Channel (6063-T5) - Standard Mill Finish
- Santoprene Insert
- Floor Construction - By Others

Available as 2 Hour Rated System - Balco Fire Barrier Systems are Tested in Accordance with ASTM E 1966 and are Listed with Omega Point Laboratories, Inc. (Contact Balco for Additional Fire Ratings)

Movement Capabilities - 50% for 9500 Series and 25% for 7500 Series

### Dual Elastomeric Floor Covers

Type	A	B
95FT-2/95FP-2/95GFP-2	2" (51mm)	9 3/8" (238mm)
95FT-3/95FP-3/95GFP-3	3" (76mm)	10 3/8" (264mm)
95FT-4/95FP-4/95GFP-4	4" (102mm)	11 3/8" (289mm)
95FT-6/95FP-6/95GFP-6	6" (152mm)	13 3/8" (340mm)
95FVT-2/95FVP-2/95GFVP-2	2" (51mm)	5 11/16" (144mm)
95FVT-3/95FVP-3/95GFVP-3	3" (76mm)	6 11/16" (170mm)
95FVT-4/95FVP-4/95GFVP-4	4" (102mm)	7 11/16" (195mm)
95FVT-6/95FVP-6/95GFVP-6	6" (152mm)	9 11/16" (246mm)

## HEAVY DUTY FLOOR COVERS

Designed for Pedestrian Traffic - Contact Factory for System Recommendations Involving Slow Vehicular Traffic Areas.

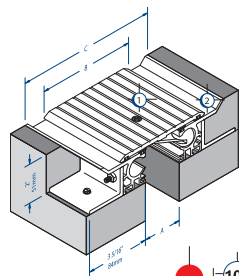

### HDNL - FORTOPPING SLAB

Floor to Wall System Also Available. Specify HDL.

### HDN Heavy Duty Floor Series

Type	A	B	C
HDN-2	2" (51mm)	5" (127mm)	8" (203mm)
HDN-3	3" (76mm)	6" (152mm)	9" (229mm)
HDN-4	4" (102mm)	7" (178mm)	10" (254mm)

50% Movement Shown - 100% Not Available

Type	A	B	C
HDNE-2	2" (51mm)	6" (152mm)	n/a
HDNE-3	3" (76mm)	7" (178mm)	n/a
HDNE-4	4" (102mm)	8" (203mm)	n/a

100% Movement Shown - 50% Also Available

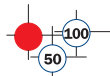

### HDNE - NEW TO EXISTING

Floor to Wall System Also Available. Specify HDNEL.

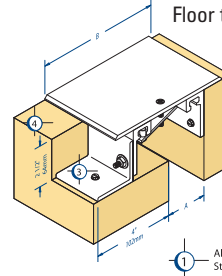

Available as 2 Hour Rated System - Balco Fire Barrier Systems are Tested in Accordance with ASTM E 1966 and are Listed with Omega Point Laboratories, Inc. (Contact Balco for Additional Fire Ratings)

Movement - Available with 100% and 50% Normal Movement Capabilities

- Aluminum Center Plate with Centering Bar - Standard Mill Finish
- Extruded Aluminum Sub-Channel (6063-T5) - Standard Mill Finish
- Carbon Steel Angle
- Floor Construction - By Others

## CS-SERIES SYSTEM

A heavy-duty system best suited for installation in multi-level garages

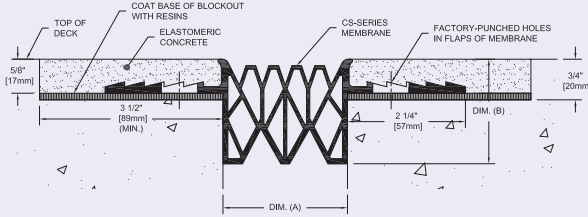

MODEL	MOVEMENT	NOMINAL (A)	MIN (A)	MAX (A)	DIM (B)
CS-250	1 1/2" (38mm)	1 1/2" (38mm)	1" (25mm)	2 1/2" (64mm)	2" (50mm)
CS-325	2" (51mm)	2" (51mm)	1 1/4" (32mm)	3 1/4" (83mm)	2 5/8" (67mm)
CS-400	2 1/2" (64mm)	2 1/2" (64mm)	1 1/2" (38mm)	4" (102mm)	3" (76mm)
CS-500	3 1/4" (83mm)	3" (76mm)	1 3/4" (44mm)	5" (127mm)	3 11/16" (94mm)
CS-600	3 7/8" (98mm)	3 1/2" (89mm)	2 1/8" (54mm)	6" (152mm)	4 3/16" (106mm)

## ES-SERIES SYSTEM

Designed for parking structure and vehicular ramp applications to withstand horizontal and vertical movements

ES SERIES ELASTIC SEAL SYSTEM

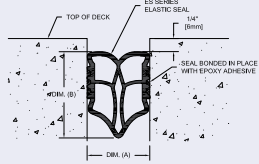

ES Elastic Seal (Relaxed Condition)  
\*Other larger sizes available, call factory.

TYPE	ACTUAL SEAL SIZE		NOMINAL JOINT DIMENSIONS		ACTUAL MOVEMENT CAPABILITY		
	WIDTH	DEPTH	WIDTH (A)	DEPTH (B)	MIN (A)	MAX (A)	TOTAL
ES-100	1" (25mm)	1 1/4" (32mm)	1" (25mm)	1 3/4" (44mm)	3/4" (19mm)	1 3/8" (35mm)	5/8" (16mm)
ES-150	1 1/2" (38mm)	1 7/8" (48mm)	1 1/2" (38mm)	2 1/2" (64mm)	1" (25mm)	2" (50mm)	1" (25mm)
ES-200	2" (51mm)	2 1/2" (64mm)	2" (51mm)	3 1/4" (83mm)	1" (25mm)	2 5/8" (67mm)	1 5/8" (41mm)
ES-250	2 1/2" (64mm)	3 1/8" (79mm)	2 1/2" (64mm)	3 3/4" (95mm)	1 3/8" (35mm)	3 1/8" (79mm)	1 3/4" (44mm)
ES-300	3" (76mm)	3 7/8" (98mm)	3" (76mm)	4 1/2" (114mm)	1 5/8" (41mm)	3 3/4" (95mm)	2 1/8" (54mm)

## FS-SERIES SYSTEM

Cost effective flexible cellular seal for horizontal and vertical applications

FS SERIES FLOOR FLEX SEAL

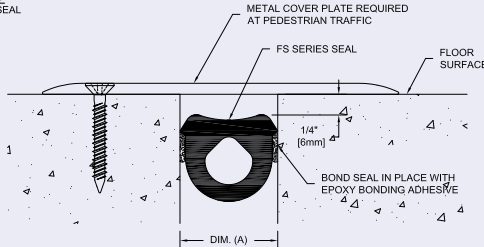

SYSTEM	INSTALL WIDTH	MINIMUM A	MAXIMUM A	MOVEMENT	SEAL SIZE
FS-100	13/16" (21mm)	7/16" (11mm)	1 1/4" (32mm)	13/16" (21mm)	1" (25mm)
FS-150	1 1/4" (32mm)	5/8" (16mm)	1 7/8" (48mm)	1 1/4" (32mm)	1 1/2" (38mm)
FS-200	1 5/8" (42mm)	7/8" (22mm)	2 1/2" (64mm)	1 5/8" (41mm)	2" (51mm)
FS-250	2" (51mm)	1 1/8" (29mm)	3 1/8" (79mm)	2" (51mm)	2 1/2" (64mm)
FS-300	2 7/16" (62mm)	1 3/8" (35mm)	3 3/4" (95mm)	2 3/8" (60mm)	3" (76mm)
FS-400	3 1/4" (83mm)	1 13/16" (46mm)	5" (127mm)	3 3/16" (81mm)	4" (102mm)

Parking Garage & Open Air Structures



# DURAFLEX™

## Exterior Expansion Joint Systems

### BCSF-SL SERIES FLOOR SYSTEM

MODEL	Width	Depth
BCSF-SL-050	1/2" (13mm)	1 1/2" (38mm)
BCSF-SL-062	5/8" (16mm)	1 1/2" (38mm)
BCSF-SL-075	3/4" (19mm)	1 1/2" (38mm)
BCSF-SL-100	1" (25mm)	2" (51mm)
BCSF-SL-125	1 1/4" (32mm)	2" (51mm)
BCSF-SL-150	1 1/2" (38mm)	2 1/2" (64mm)
BCSF-SL-175	1 3/4" (44mm)	2 1/2" (64mm)
BCSF-SL-200	2" (51mm)	3" (76mm)
BCSF-SL-225	2 1/4" (57mm)	3" (76mm)
BCSF-SL-250	2 1/2" (64mm)	3 1/2" (89mm)
BCSF-SL-275	2 3/4" (70mm)	3 1/2" (89mm)
BCSF-SL-300	3" (76mm)	3 1/2" (89mm)
BCSF-SL-325	3 1/4" (83mm)	4" (102mm)
BCSF-SL-350	3 1/2" (89mm)	4" (102mm)
BCSF-SL-375	3 3/4" (95mm)	4" (102mm)
BCSF-SL-400	4" (102mm)	4" (102mm)

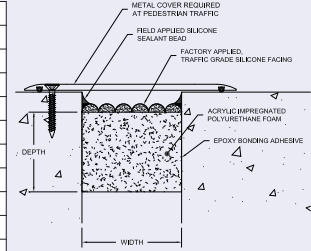

### BCSW-SERIES WALL SYSTEM

Used to fill larger vertical construction movement joints where an aesthetically pleasing appearance is required or where there is anticipated seismic movement.

MODEL	Width	Depth
BCSW-100	1" (25mm)	1 1/2" (38mm)
BCSW-125	1 1/4" (32mm)	2" (51mm)
BCSW-150	1 1/2" (38mm)	2" (51mm)
BCSW-175	1 3/4" (44mm)	2" (51mm)
BCSW-200	2" (51mm)	3" (76mm)
BCSW-225	2 1/4" (57mm)	3" (76mm)
BCSW-250	2 1/2" (64mm)	3" (76mm)
BCSW-275	2 3/4" (70mm)	3" (76mm)
BCSW-300	3" (76mm)	3" (76mm)
BCSW-325	3 1/4" (83mm)	4" (102mm)
BCSW-350	3 1/2" (89mm)	4" (102mm)
BCSW-375	3 3/4" (95mm)	4" (102mm)
BCSW-400	4" (102mm)	4" (102mm)

BCSW SERIES COMPRESSED WALL SEAL WITH COLORIZED SILICONE FACING 50% MOVEMENT AVAILABLE MAXIMUM LENGTH 42" (1067mm)

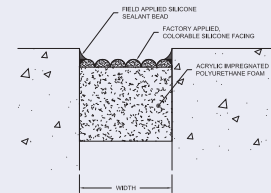

## EXTRA-HEAVY DUTY FLOOR COVERS

This Heavy Duty System is Available with a Serrated Cover Plate or Plain Cover Plate; Specify XH4FS/XH4FVS for Serrated or XH4FP/XH4FVP for Plain.

### XH4FS

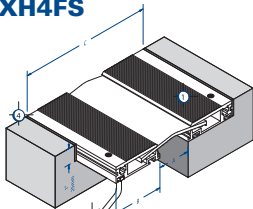

### OPTIONAL COVER PLATE MATERIALS

XH4FS/XH4FP/XH4FVS/XH4FVP Series Floor Cover are Also Available with Stainless Steel and Architectural Bronze Cover Plates. (Base Members are Aluminum Extrusions) Specify SSXH4FS/SSXH4FP/SSXH4FVS/ SSXH4FVP for Stainless Steel, BXH4FS/BXH4FP/BXH4FVS/ BXH4FVP for Bronze.



### Extra-Heavy Duty Series

Type	A	B	C	Movement	Max. Concentrated Load for Joint in Neutral Position
XH4FS-1	1" (25mm)	2 1/8" (54mm)	5 1/4" (133mm)	+/- 1" (25mm)	640 lbs. (2.85 kN)
XH4FS-1-2	2" (51mm)	2 1/8" (54mm)	6 1/4" (159mm)	+/- 1" (25mm)	1104 lbs. (4.91 kN)
XH4FS-2	2" (51mm)	3 1/8" (79mm)	8 1/4" (210mm)	+/- 2" (51mm)	1104 lbs. (4.91 kN)
<b>Floor to Wall</b>					
XH4FVS-1	1" (25mm)	2 1/8" (54mm)	3 1/8" (79mm)	+/- 1/2" (38mm)	640 lbs. (2.85 kN)
XH4FVS-1-2	2" (51mm)	2 1/8" (54mm)	4 1/8" (105mm)	+/- 1/2" (38mm)	1104 lbs. (4.91 kN)
XH4FVS-2	2" (51mm)	3 1/8" (79mm)	5 1/8" (130mm)	+/- 1" (25mm)	1104 lbs. (4.91 kN)

#### Notes:

1. Loads are based on 6063-T5 aluminum.
2. Concentrated load is applied to a 2" (51mm) diameter circle.
3. 1 kN = 1000 newtons

## METAFLX® 5000 METAMAT™

New easy to install Intumescent 2, 3 and 4 hour rated fire barrier design for joints up to 6" maximum opening for floor and wall applications, interior and exterior applications.

MetaFlex® 5000			
MetaMat™ - UL Listed			
FLOOR		WALL	
Model #	Application	Model #	Application
MF2H03	Floor to Floor Balco 7500 series. Roof bellows and shaft walls with maximum opening of 3" with EPDM covers.	MW2H03	All metal covers in wall to wall conditions with maximum opening of 3"
MFV2H03	Floor to Wall Balco 7500 series. Roof bellows and shaft walls with maximum opening of 3" with EPDM covers.	MCW2H03	All metal corner wall conditions with maximum opening of 3"
MF2H04F	All floor to floor conditions with metal covers maximum opening of 4" All aluminum roof covers	MW2H04	All wall to wall conditions with maximum opening of 4"
MFV2H04F	All floor to wall conditions with metal covers maximum opening of 4" All aluminum roof covers	MCW2H04	All corner wall conditions with maximum opening of 4"
MF2H06	All floor to floor conditions with metal covers with maximum opening of 6"	MW2H06	All wall to wall conditions with maximum opening of 6"
MFV2H06	All floor to wall conditions with metal covers with maximum opening of 6"	MCW2H06	All corner conditions with maximum opening of 6"

Material sold in 20 linear foot increments, on 20 foot, 40 foot or 80 foot rolls

## METAFLX® 5000 METABLOCK™

New easy to install Intumescent 2 hour rated fire barrier design to be used in conjunction with Balco's DuraFlex expansion joint systems, for joints up to 4" maximum opening for floor and wall applications, interior and exterior applications.

FLOOR		WALL	
MetaBlock™		MetaBlock™	
MBF2H02	For use with ES and FS series and metal covers with a max open 2" - 2 Hour Rating	MBW2H02	For use with ES and FS series with a max open 2" - 2 Hour Rating
MBF2H04	For use with CS, ES and FS series and metal with a max open 4" - 2 Hour Rating	MBW2H04	For use with ES and FS series and metal with a max open 4" - 2 Hour Rating
MBF3H04	For use with CS, ES and FS series with a max open 4" - 3 Hour Rating		
MBF4H04	For use with CS, ES and FS series and metal with a max open 4" - 4 Hour Rating		

MCW2H03

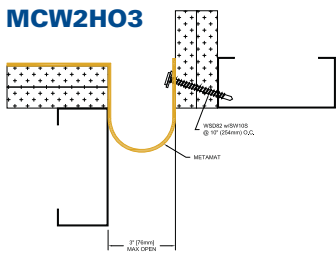

MF2H04F

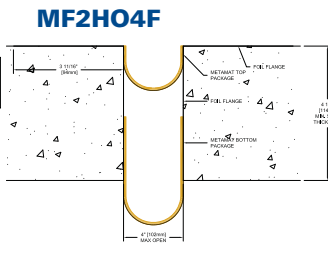

CS-SERIES

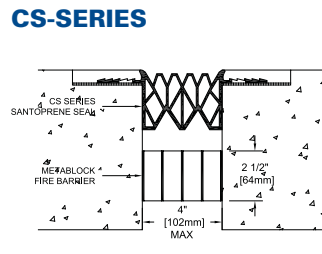

ES-SERIES

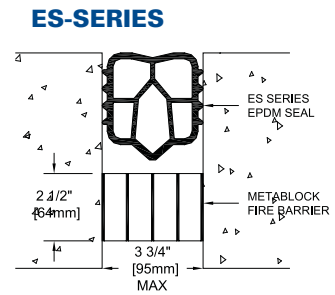

MW2H03

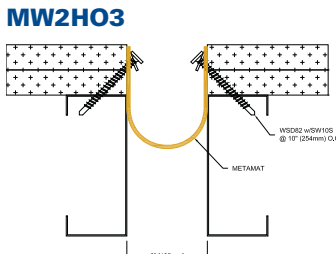

FS-SERIES

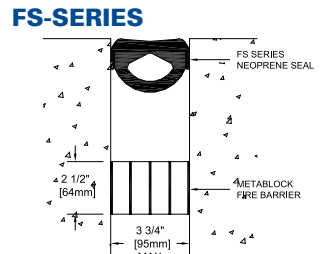

**Q**uality products engineered and crafted to meet tomorrow's needs today... Over 50 years in the business is proof that we stand behind those words. Balco has set an industry benchmark with our combination of highly skilled engineers, manufacturing processes, and drafting designs. We customize our products to fit your projects' needs. At Balco, we're dedicated to bringing you the highest quality products at competitive prices. Let us be an integral part of your next project.

## Other BALCO Products



**BALCO INC**

2626 S. Sheridan • Wichita, KS 67217  
Ph: 316.945.9328 • Fx: 316.945.0789

1.800.767.0082  
www.balcousa.com

