

Windows

*Specializing in
Pass-Thru & Drive-Up
Applications and
Speak Hole Covers*





PRODUCT OVERVIEW

Construction: All windows are surface mounted – no obstruction or grooves in the counter. The bottom channel of vertical and horizontal sliding windows are fitted with a wool pile seal on the active sash and screen for counter contact.

Material: Frames and glass channels of heavy type 6063-T5 aluminum extrusions.

Screens: Standard brite aluminum. Optional fiberglass, and bronze aluminum screens are available upon request.

Finish: Anodized 204R-1 clear aluminite is standard. 215R-1 Clear, anodic hardcoat colors or white baked enamel is available for all windows on special order.

Due to additional thickness of baked enamel paint, powder coat paint and kynar finishes, sliding operation of windows may be hampered. Additional curing time may be required for special finishes.

Glass: 1/4" clear plate for windows not over 24" wide. For windows wider than 24", DSB glass is recommended. Glazing is extruded vinyl bead. NOTE: specify "Frames Only" or type of glass to be factory installed.

Bullet Resistant Glazing: Bullet resistant glass – 1 1/4" bullet resistant plexiglass, and 3/4" "Lexgard" is available in all stationary and registration window systems.

Shipping: All glazed windows are packed in wooden crates. Unglazed windows are shipped in cardboard cartons.

All shipping charges are "Freight Collect", unless prior arrangements are made.

LOCKS & COUNTER SEAL DETAILS

Locks: Sliding bolt or pin type locks are standard. Please specify type of lock desired. Optional key type locks are available at extra cost. NOTE: sliding bolt locks are not available on "BP" series windows.

A brush type wool pile counter seal is used to prevent drafts.

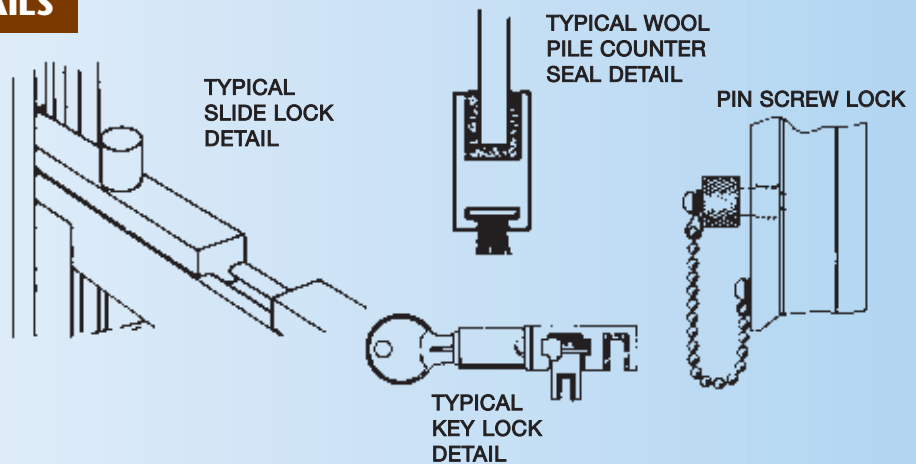

INSTALLATION

Place complete frame and window assembly on counter between mullions. Attach to mullions by concealed screws through channel walls.

Surround Detail: If window frame must be sealed into wall opening, an optional "Surround Frame" is available on special order that provides easy installation and removal of the complete window assembly for servicing. Mullions and counters by others.

Removable Sash Channel: A special removable frame is available on special order for Series "C" & "BP" window.

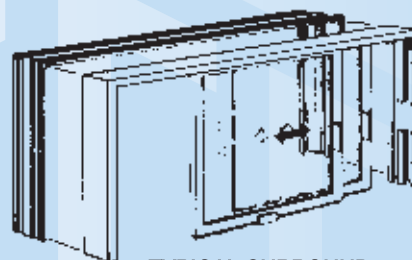

TYPICAL SURROUND FRAME DETAIL



SPECIAL REMOVABLE SASH CHANNEL

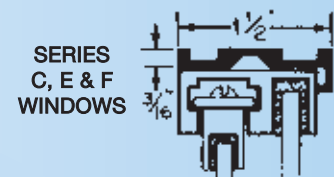

SERIES C, E & F WINDOWS

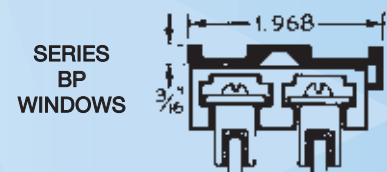

SERIES BP WINDOWS

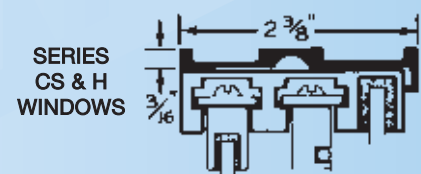

SERIES CS & H WINDOWS

HOW TO ORDER

When you place an order or request pieces, there are several items we must know to provide you with the proper product and the right price. Please check the following items carefully so that we may serve you better.

- What series window or type of product do you need? Refer to our catalogue or price list for Stock No's.
- Provide us with the dimensions of width and height of each window.

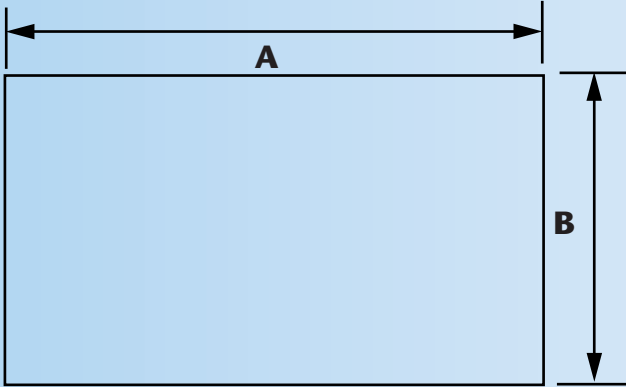

- List each of your requirements for Type of Lock, Finish, Glass:

STANDARD LOCK:

- Standard Lock
- Screw/Pin Lock

Optional:

- Key Lock

STANDARD FINISH:

- 204R-1 Clear Aluminum

Optional:

- Medium Bronze
- Dark Bronze
- Black
- Baked Enamel
- White

GLASS:

- Frames Only
- Vinyl For _____
- DSB Glass
- 1/4" Plate
- 3/16" Crystal Glass
- 1/4" Wire Glass
- 1/8" Plexiglass
- 1/4" Plexiglass
- 1/4" Lexan
- 1/4" Tempered
- Other

If you require custom counters or special "Bullet Resistant" items, we will require a dimensioned drawing or sketch. Just "FAX" it!

24 HOUR FAX LINE (626) 579-0628

Our "FAX" line is available 24 hours a day. Send your drawings or sketch anytime and eliminate misunderstandings and wrong quotes. Get it right the first time — FAX IT!

SPECIAL ORDERS

"Special Orders Are Our Specialty"...The size of items listed in this catalog are standard items but we will gladly manufacture any special sizes you may require. The special sizes will be manufactured in the same time as a standard item. Special size pass windows are provided at no extra cost.

INDEX

- 2**
- General Specifications
 - Lock and Counter Seal Detail
 - Installation

- 3**
- How to Order
 - Simplify Your Order... Fax it
 - Special Orders

- 4**
- Custom Windows & Counters
 - Security Pass-Thru Windows
 - Coin Tray, Package Pass-Thru



- 5**
- Security Slide Out Drawers
 - Electronic Intercom



- 6**
- Series C and CS With and without screens
 - Series D V-vertical, H-horizontal



- 7**
- Series BP, BPS & BPI By Pass Windows BP: regular, BPI: insulated Both Panels Slide

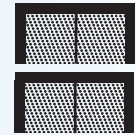

- 8**
- Series E, G, & EI E: regular, no screen G: with screen EI: insulated glass

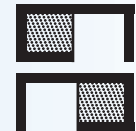

- 9**
- Series F: Three panel window with two stationary sections, with or without screens
 - Series H: Two active windows with or without screens

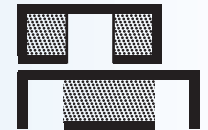

- 10**
- Ticket Windows Round & Rectangular
 - Utility Doors

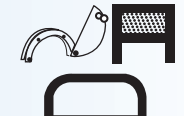

- 11**
- Speak Holes
 - Mail Slots



- 12**
- Steel Sliding
 - Fire Windows 3/4 hr. Fire Rated ICC-ES Approved





Custom and Bullet Resistant Windows and Counters

Custom Windows & Counters: Special sizes will be quoted on request. Submit required measurements: Width—distance between vertical mullions. Height—from counter top, up to the bottom of the horizontal member. Sash balances for the larger windows are available and custom windows are available and custom windows can be built to meet your requirements on special order. "FAX IT"—(626) 579-0628

NISSEN NIGHT REGISTRATION WINDOW

The Nissen Night Registration Window with 1 1/4" bullet resistant plexiglass consists of a counter, coin tray and surrounding housing constructed of 16 gauge stainless steel. The complete unit is designed to slide into a 14 1/2" x 19 1/2" rough opening.



NISSEN ROTATING SHELF/WINDOW

A convenient Rotating Shelf to serve package goods from an enclosed area. Aluminum construction with one fixed glass panel and speak hole for installation between mullions. Options include: stainless steel construction with security baffles, custom built vertical or horizontal combinations, with or without sliding windows.

STOCK NO.
RS200/RS201



FACTORY ASSEMBLED TICKET WINDOWS

The factory assembled unit includes the following: A 24" x 36" framed stationary window with a No. 410 speak hole with cover and No. 724 ticket window installed in 1/4" clear tempered glass. The unit includes a 24" x 18" x 2" - 18 gauge stainless steel counter.

Stock No. SCW102

Note: 1/2" glazing is available on special order.

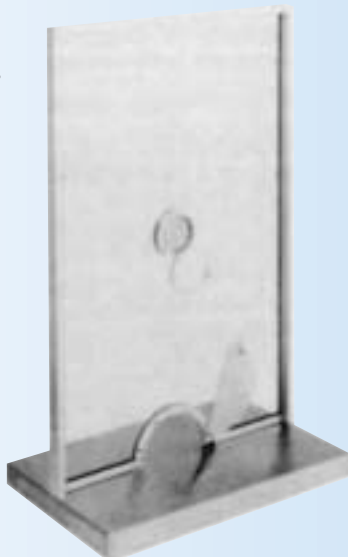

STOCK NO. SCW102

FACTORY ASSEMBLED CASHIER WINDOWS

A stationary 30" x 30", 1/4" tempered glass window is complete with aluminum frame and a No. 410 Speak Hole installed. Counter and coin tray are fabricated of 18 gauge stainless steel.

Stock No, SCW103

Note: 1/2" glass or 3/4" Lexard (Bullet Resistant) glazing is available on special order.



STOCK NO. SCW103

Note: All windows are shown from the inside looking out.

DEAL DRAWERS

This stainless steel sliding tray system is recessed in the counter top and front to achieve a flush appearance. Full width push-pull handle and solid bearing slides allow easy operation.

Stock No.4616 – Stainless Steel Sliding Deal Tray

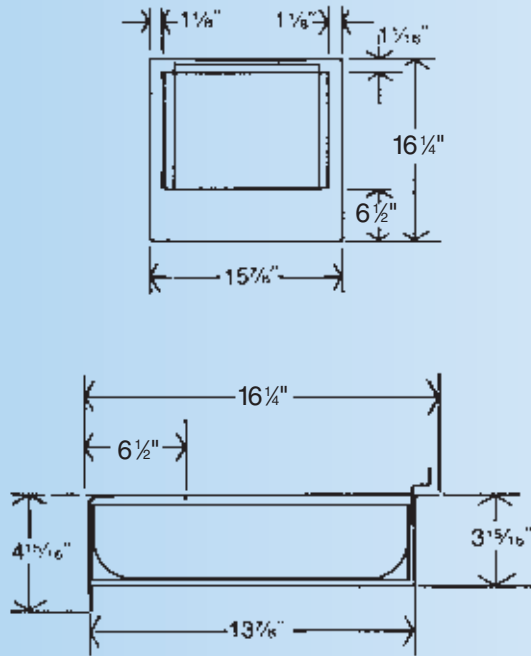

TRANSACTION DRAWER

The weather resistant "Transaction Drawer" allows a clear view of the contents through clear Lexan lid preventing direct entry of outside air. The "Bullet Resistant" construction, materials and operation protects the operator at all times. Drawer is equipped with smooth action ball bearing extension slides (15" extension). Spring bill clip holds paper currency in place, stainless steel coin scoop for loose change.

Stock No.4424 Bullet/Weather Resistant Transaction Drawer

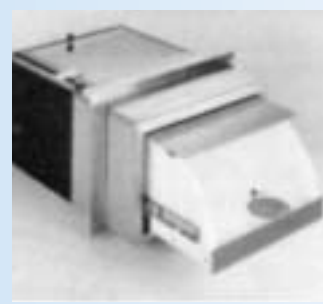
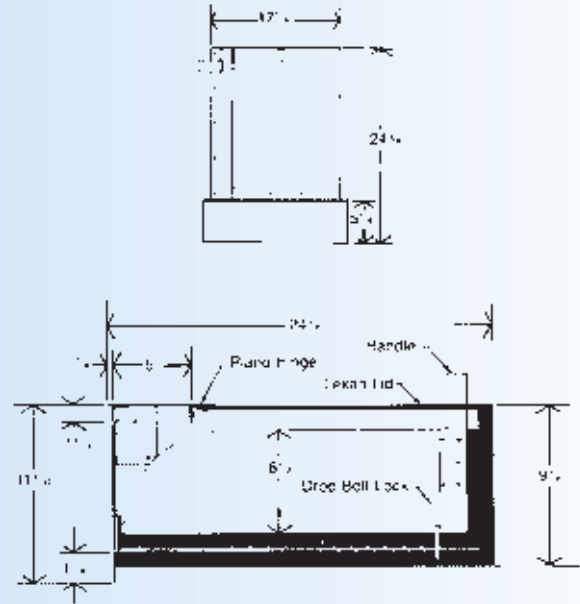

COIN & CASH TRAY

Coin and cash tray may be installed in new or existing counter tops. Allows glass to extend full length of opening to offer "Security in Serving".

Material: 18 gauge (.048) – 304 Stainless Steel with a #4 Fine Brush Finish.

NO.	DESCRIPTION
T12SS	12" x 14 3/8" x 2 1/4" Deep
T18SS	18" x 14 3/8" x 2 1/4" Deep
T24SS	24" x 14 3/8" x 2 1/4" Deep





Sliding Serving Windows

SERIES "C" & "CS" & "D" WINDOWS

Series "C" Windows (without screens)

Vertical sliding serving windows without a screen for installation between mullions.

Features:

- Nylon runners over coiled compression springs provide smooth operation.
- Window holds in placed position.

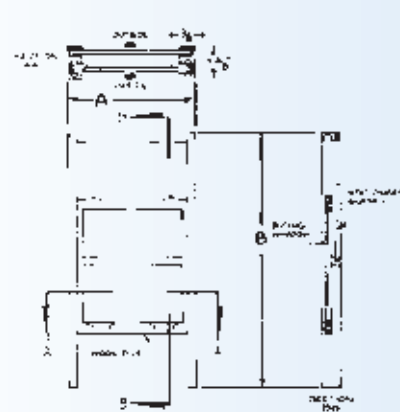
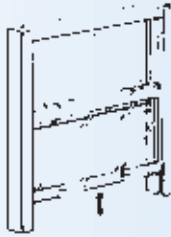

Series "CS" Windows (with screens)

Vertical sliding serving windows with a sliding screen for installation between mullions.

Features:

- Nylon runners over coiled compression springs provide smooth operation.
- Window holds in placed position.

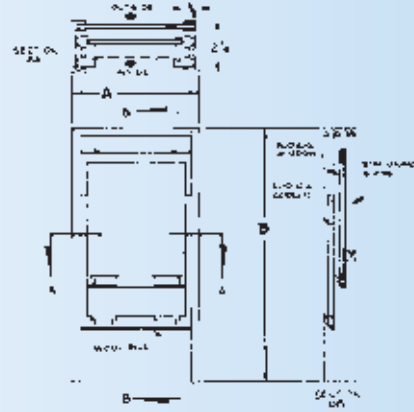

Series "C", "CS" and "D" Windows with Sash Balances

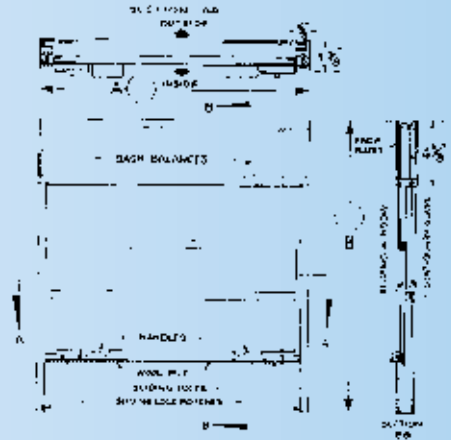

SERIES C NO.	OVERALL SIZE		SERVING AREA SIZE
	without surround (A)	with surround (B)	
C-1224	12" x 24"	12 3/8" x 24 3/16"	10 3/4" x 11 3/8"
C-3624	36" x 24"	36 3/8" x 24 3/16"	34 3/4" x 11 3/8"
C-1530	15" x 30"	15 3/8" x 30 3/16"	13 3/4" x 14 3/8"
C-3630*	36" x 30"	36 3/8" x 30 3/16"	34 3/4" x 14 3/8"
C-2436	24" x 36"	24 3/8" x 36 3/16"	22 3/4" x 17 3/8"
C-3636*	36" x 36"	36 3/8" x 36 3/16"	34 3/4" x 17 3/8"

SERIES CS NO.	OVERALL SIZE		SERVING AREA SIZE
	without surround (A)	with surround (B)	
CS-1224	12" x 24"	12 3/8" x 24 3/16"	10 3/4" x 11 3/8"
CS-3624	36" x 24"	36 3/8" x 24 3/16"	34 3/4" x 11 3/8"
CS-1530	15" x 30"	15 3/8" x 30 3/16"	13 3/4" x 14 3/8"
CS-3630*	36" x 30"	36 3/8" x 30 3/16"	34 3/4" x 14 3/8"
CS-2436	24" x 36"	24 3/8" x 36 3/16"	22 3/4" x 17 3/8"
CS-3636*	36" x 36"	36 3/8" x 36 3/16"	34 3/4" x 17 3/8"

*Note: Windows 36" x 36" and greater require sash counter balances.

SERIES "D" WINDOWS

Vertical: Vertical sliding serving window for installation between mullions, behind a wall, stationary glass or into a pocket.

Horizontal: Horizontal sliding serving window for installation between mullions, behind a wall, stationary glass or into a pocket.

Features:

- Nylon runners over coiled compression springs provide smooth operation.
- Window holds in placed position.

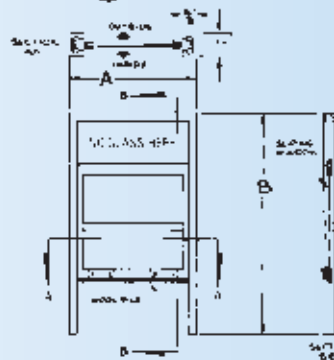
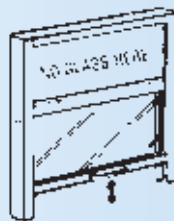

SERIES D NO.	OVERALL SIZE		SERVING AREA SIZE
	without surround (A)	with surround (B)	
1210-V	12" x 21"	12 3/8" x 21 3/16"	10 3/4" x 10"
1212-V	12" x 25"	12 3/8" x 25 3/16"	10 3/4" x 12"
2418-V	24" x 37"	24 3/8" x 37 3/16"	22 3/4" x 18"

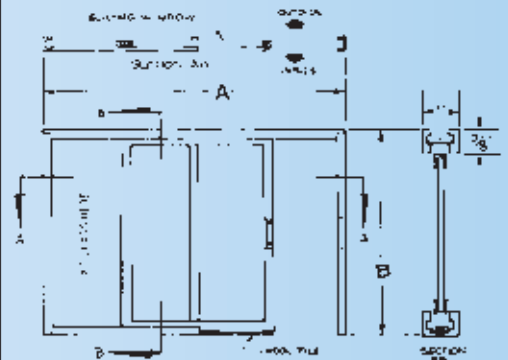
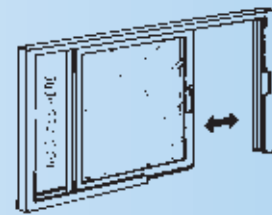

SERIES D NO.	OVERALL SIZE		SERVING AREA SIZE
	without surround (A)	with surround (B)	
3610-H	38" x 10"	38 3/8" x 10 3/16"	17 3/4" x 11 3/8"
3612-H	38" x 12"	38 3/8" x 12 3/16"	18" x 11 3/8"
3618-H	38" x 18"	38 3/8" x 18 3/16"	18" x 14 3/8"

Sliding Serving Windows

SERIES "BP" & "BPS" WINDOWS

Horizontal sliding by-passing serving window for installation between mullions. Please specify "BP" for windows without screens or "BPS" for windows with screens.

Features:

- Top hung on nylon glides
- Pin Screw Lock standard
- Key Lock is available at extra cost.

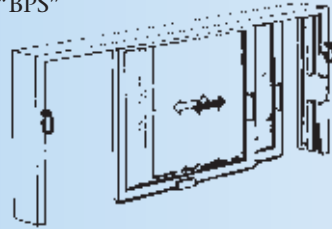

Note: Series "BP" Serving Windows are available for 1/2" thick glass. Extra long frame for pocket installation is available on special order.

For larger sizes, bottom track with bearings is recommended.

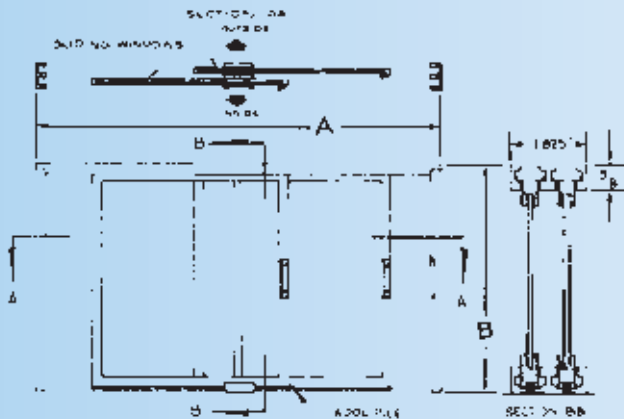

**SERIES "BP" (left)
Without Screens**

**SERIES "BPS" (below)
With Screens**

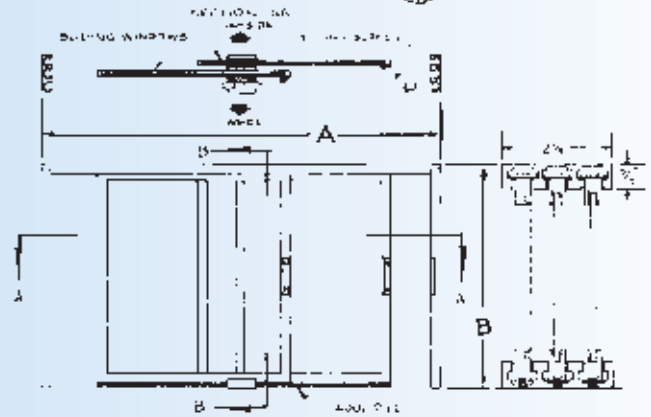
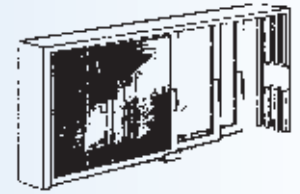

SERIES BP & BPS NO.	OVERALL SIZE		SERVING AREA SIZE
	without surround (A) (B)	with surround (A) (B)	
2612	26" x 12"	26 3/8" x 12 3/16"	12" x 11 3/8"
5012	50" x 12"	50 3/8" x 12 3/16"	24" x 11 3/8"
2615	26" x 15"	26 3/8" x 15 3/16"	12" x 14 3/8"
3815	38" x 15"	38 3/8" x 15 3/16"	18" x 14 3/8"
5015	50" x 15"	50 3/8" x 15 3/16"	24" x 14 3/8"
2618	26" x 18"	26 3/8" x 18 3/16"	12" x 17 3/8"
5018	50" x 18"	50 3/8" x 18 3/16"	24" x 17 3/8"
2624	26" x 24"	26 3/8" x 24 3/16"	12" x 23 3/8"
3424	34" x 24"	34 3/8" x 24 3/16"	15" x 23 3/8"
5024	50" x 24"	50 3/8" x 24 3/16"	24" x 23 3/8"

SERIES "BPI" INSULATED GLASS SERVING WINDOWS

Horizontal sliding by-passing serving window glazed with insulated glass panels for installation between mullions.

Features:

- Top hung on nylon glides.
- Key Lock is available at extra cost

Note: "BPI" windows are available on special order: with 1/2" thick glass, with extra long frame for pocket installation, with screens.

For larger sizes, bottom track with bearings is recommended.

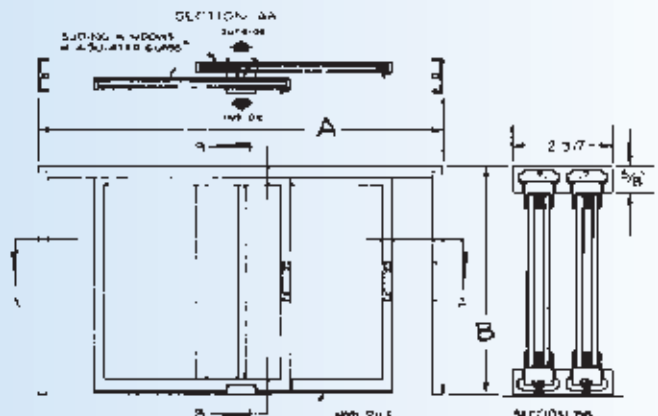
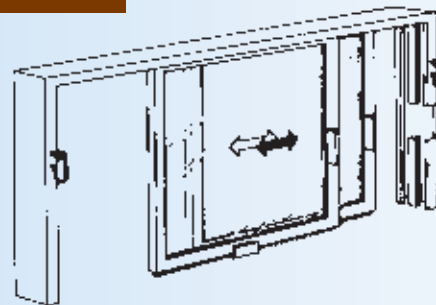

SERIES BPI NO.	OVERALL SIZE		SERVING AREA SIZE
	without surround (A) (B)	with surround (A) (B)	
BPI-2612	26" x 12"	26 3/8" x 12 3/16"	12" x 11 3/8"
BPI-5012	50" x 12"	50 3/8" x 12 3/16"	24" x 11 3/8"
BPI-2615	26" x 15"	26 3/8" x 15 3/16"	12" x 14 3/8"
BPI-3815	38" x 15"	38 3/8" x 15 3/16"	18" x 14 3/8"
BPI-5015	50" x 15"	50 3/8" x 15 3/16"	24" x 14 3/8"
BPI-2618	26" x 18"	26 3/8" x 18 3/16"	12" x 17 3/8"
BPI-5018	50" x 18"	50 3/8" x 18 3/16"	24" x 17 3/8"
BPI-2624	26" x 24"	26 3/8" x 24 3/16"	12" x 23 3/8"
BPI-3424	34" x 24"	34 3/8" x 24 3/16"	15" x 23 3/8"
BPI-5024	50" x 24"	50 3/8" x 24 3/16"	24" x 23 3/8"



Sliding Serving Windows

SERIES "E" AND "G" WINDOWS

SERIES E WINDOWS (without screen)

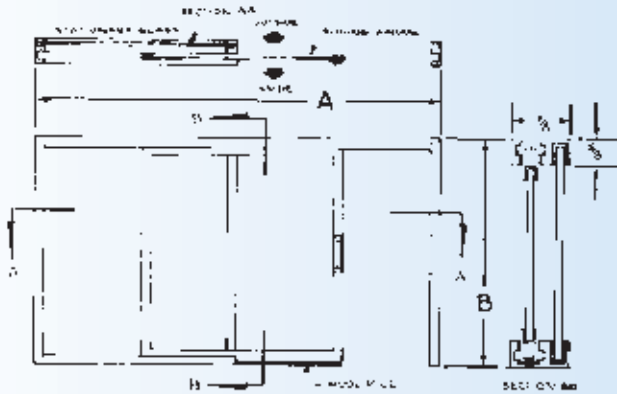
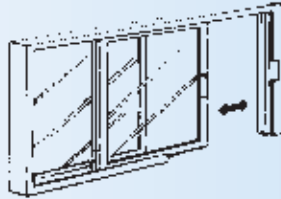

SERIES G WINDOWS (with screen)

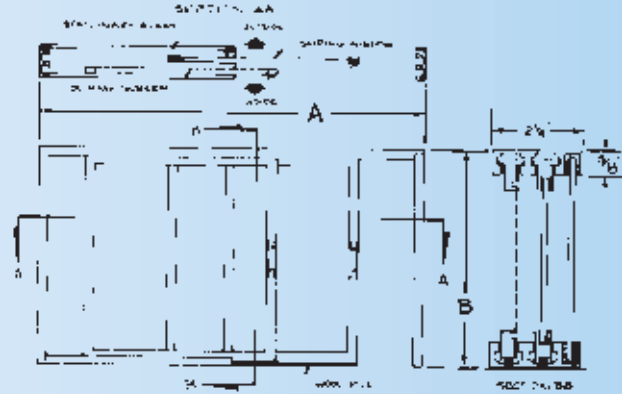
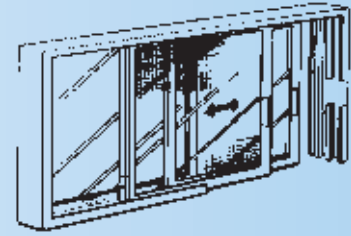

Horizontal sliding serving window. Specify Series "E" for windows without screens and Series "G" for windows with screens. For installation between mullions.

Features:

- Top hung on nylon glides
- If active sash is desired at opposite end – specify Left hand. (Inside elevation)

Note: Series "E" serving windows are available for 1/2" thick glass. For larger sizes bottom track with bearings is recommended.

SERIES E & G NO.	OVERALL SIZE		SERVING AREA SIZE
	without surround (A) (B)	with surround (A) (B)	
1212	26" x 12"	26 3/8" x 12 3/16"	11 3/4" x 11 3/8"
2412	50" x 12"	50 3/8" x 12 3/16"	23 3/4" x 11 3/8"
1215	26" x 15"	26 3/8" x 15 3/16"	11 3/4" x 14 3/8"
2415	50" x 15"	50 3/8" x 15 3/16"	23 3/4" x 14 3/8"
1218	26" x 18"	26 3/8" x 18 3/16"	11 3/4" x 17 3/8"
2418	50" x 18"	50 3/8" x 18 3/16"	23 3/4" x 17 3/8"
1221	26" x 21"	26 3/8" x 21 3/16"	11 3/4" x 20 3/8"
2421	50" x 21"	50 3/8" x 21 3/16"	23 3/4" x 20 3/8"
1224	26" x 24"	26 3/8" x 24 3/16"	11 3/4" x 23 3/8"
2424	50" x 24"	50 3/8" x 24 3/16"	23 3/4" x 23 3/8"

SERIES "EI" INSULATED GLASS WINDOWS

Horizontal sliding serving windows without screens, glazed with insulated glass panels, for installation between mullions.

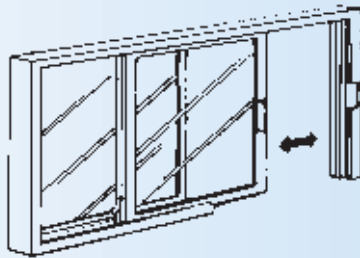

Features:

- Top hung on nylon glides
- If active sash is desired at opposite end – specify Left Hand. (Inside elevation)

Note: Series "EI" serving windows are available for screens on special order. For larger sizes, bottom track with bearings is recommended.

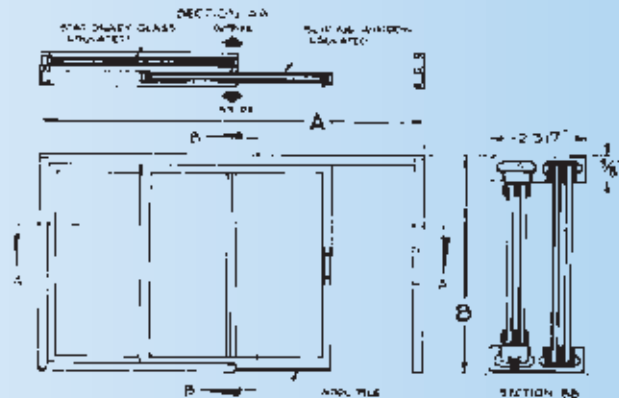

SERIES EI NO.	OVERALL SIZE		SERVING AREA SIZE
	without surround (A) (B)	with surround (A) (B)	
E1-1212	26" x 12"	26 3/8" x 12 3/16"	11 3/4" x 11 3/8"
E1-2412	50" x 12"	50 3/8" x 12 3/16"	23 3/4" x 11 3/8"
E1-1215	26" x 15"	26 3/8" x 15 3/16"	11 3/4" x 14 3/8"
E1-2415	50" x 15"	50 3/8" x 15 3/16"	23 3/4" x 14 3/8"
E1-1218	26" x 18"	26 3/8" x 18 3/16"	11 3/4" x 17 3/8"
E1-2418	50" x 18"	50 3/8" x 18 3/16"	23 3/4" x 17 3/8"
E1-1221	26" x 21"	26 3/8" x 21 3/16"	11 3/4" x 20 3/8"
E1-2421	50" x 21"	50 3/8" x 21 3/16"	23 3/4" x 20 3/8"
E1-1224	26" x 24"	26 3/8" x 24 3/16"	11 3/4" x 23 3/8"
E1-2424	50" x 24"	50 3/8" x 24 3/16"	23 3/4" x 23 3/8"

Note: All windows are shown from the inside looking out.

Sliding Serving Windows

SERIES "F" WINDOWS

Horizontal three panel sliding serving window with two stationary sections. The sliding window and screen operate in the same channel. For installation between mullions.

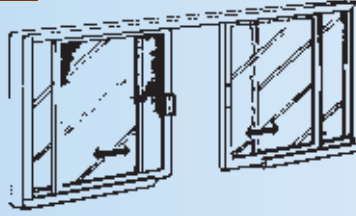

SERIES F NO.	OVERALL SIZE		SERVING AREA SIZE
	without surround (A)	with surround (B)	
F-1212	40" x 12"	40 3/8" x 12 3/16"	11 3/4" x 11 3/8"
F-3012	94" x 12"	94 3/8" x 12 3/16"	29 3/4" x 11 3/8"
F-1615	52" x 15"	52 3/8" x 15 3/16"	15 3/4" x 14 3/8"
F-3015	94" x 15"	94 3/8" x 15 3/16"	29 3/4" x 14 3/8"
F-2018	64" x 18"	64 3/8" x 18 3/16"	19 3/4" x 17 3/8"
F-3018	94" x 18"	94 3/8" x 18 3/16"	29 3/4" x 17 3/8"
F-2020	64" x 20"	64 3/8" x 20 3/16"	19 3/4" x 19 3/8"
F-3020	94" x 20"	94 3/8" x 20 3/16"	29 3/4" x 19 3/8"

Features:

- Active sash and screen top hung on nylon glides.

Note: Series F windows may be glazed with insulated glass panels or 1/2" thick glass on special order. Also available in OXXO with or without screens.

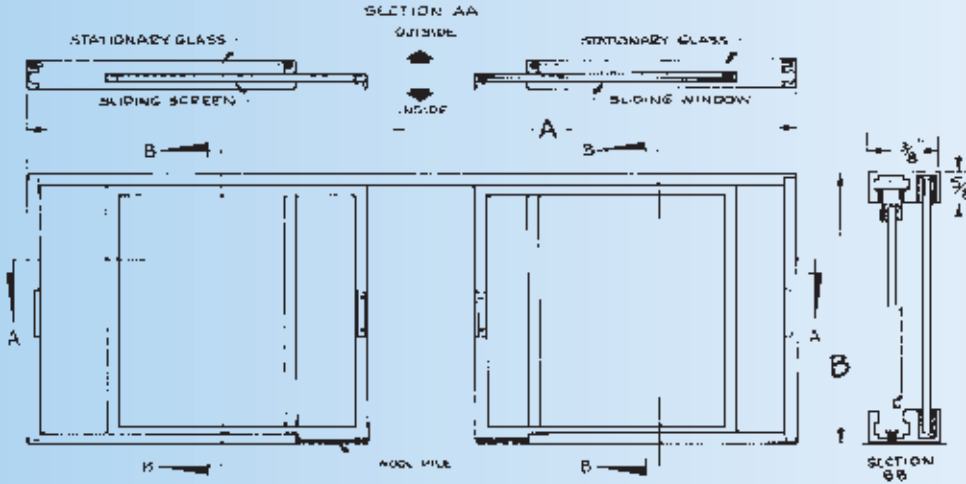

SERIES "H" WINDOWS

Horizontal sliding serving window with two sliding windows and screens operating in separate channels on both sides of a central stationary section. For installation between mullions.



SERIES H NO.	OVERALL SIZE		SERVING AREA SIZE
	without surround (A)	with surround (B)	
H2-1212	52" x 12"	52 3/8" x 12 3/16"	12" x 11 3/8"
H2-3012	124" x 12"	124 3/8" x 12 3/16"	30" x 11 3/8"
H2-1415	60" x 15"	60 3/8" x 15 3/16"	14" x 14 3/8"
H2-3015	124" x 15"	124 3/8" x 15 3/16"	30" x 14 3/8"
H2-1418	60" x 18"	60 3/8" x 18 3/16"	14" x 17 3/8"
H2-3018	124" x 18"	124 3/8" x 18 3/16"	30" x 17 3/8"

Features:

- Active sash and screen top hung on nylon glides

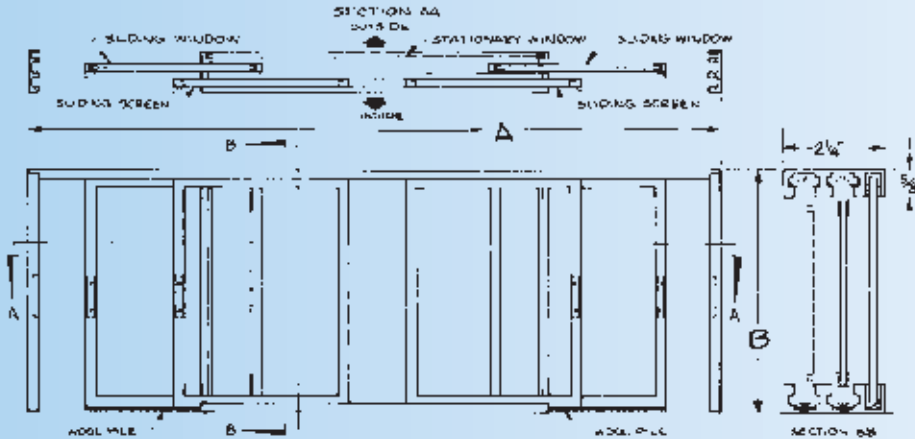

Note: All windows are shown from the inside looking out.



Ticket Windows, Cashier Doors and Mail Slots

TICKET WINDOW (ROUND)

1/4", 1/2", 1 1/2" Plate Glass:

Features: The smartly styled semi-circular aluminum ticket window is designed to meet architects specifications. The swing away door is equipped with a tamper proof spring loaded snap lock plus a retaining pin for security. Easy installation on 1/4" glass.

Note: The 720 series can be fabricated for thicker glass including (1 1/2").

NO.	OVERALL SIZE (A) (B)	OPENING SIZE
724	8" x 4"	6 1/2" x 3 1/4"
725	10" x 5"	8 1/2" x 4 1/2"
726	12" x 6"	10 1/2" x 5 1/4"

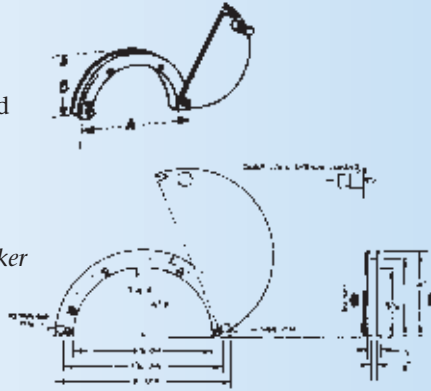

TICKET WINDOW

1/4" Plate Glass:

Features: Side Channels and Window frames are heavy aluminum Extrusions... Nylon Sides with Lifetime Compression Coil Springs for Permanent Tension... Easy operation... Wool pile seal on lower window frame... Window comes factory assembled ready for installation... No obstructions or grooves in window opening on counter... Beautiful alumilite.

NO.	OVERALL SIZE (A) (B)	OPENING SIZE
701	9 1/2" x 8 1/2"	8 1/4" x 3 1/2"
702	19 1/4" x 8 1/2"	18" x 3 1/2"

Note: Available for installation in 1/2" glass.

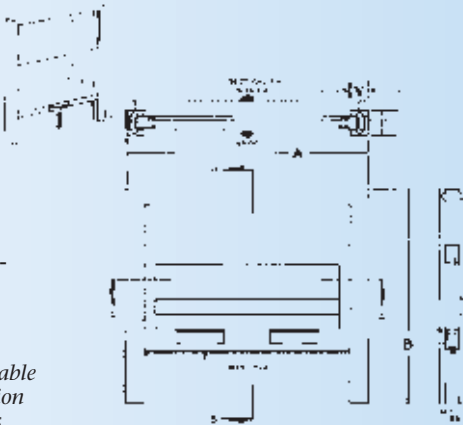

CASHIER/UTILITY DOORS

1/4" Plate Glass:

Features: Harmonious design... Beautiful alumilite finish... No mounting screws used... Simple to install... Fully reversible... Door automatically opens when inside latch bar is retracted... No more broken fingernails..

NO.	OVERALL SIZE (A) (B)	OPENING SIZE (C) (D)
300*	9 1/4" x 11"	8" x 10"
522	9 7/8" x 5 1/8"	8 7/8" x 4 1/2"
532	12 1/2" x 5 1/8"	11 1/2" x 4 1/2"

* Latch Lock Only

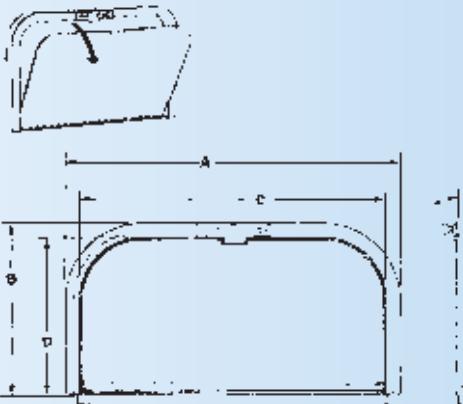

MAIL SLOTS

1/4" Plate Glass:

Features: Extruded aluminum... No mounting screws required... All mechanism concealed... Beautiful aluminum finish... Harmonious design... Low in cost... Simple

NO.	OVERALL SIZE (A) (B)	MAIL OPENING (E) (F)
888**	2 5/8" x 9 5/8"	1 3/4" x 8 5/8"
900*	2 5/8" x 9 5/8"	1 3/4" x 8 5/8"
905	2 5/8" x 9 5/8"	1 3/4" x 8 5/8"
922*	2 5/8" x 12 1/8"	1 3/4" x 11 1/8"
925	2 5/8" x 12 1/8"	1 3/4" x 11 1/8"
933	2 5/8" x 16"	1 3/4" x 15"
935	2 5/8" x 16 1/8"	1 3/4" x 15"

** No lock or channel insert

* No lock

installation... Fully reversible... For door or side lite... Flap spring loaded... Glass channel inserts... Special finishes available... Special sizes to order.

Note: Glass channel inserts are integral part of our deluxe mailslots. Thus eliminating water and dirt penetration. Only Nissen & Co., Inc., slots have this important feature.

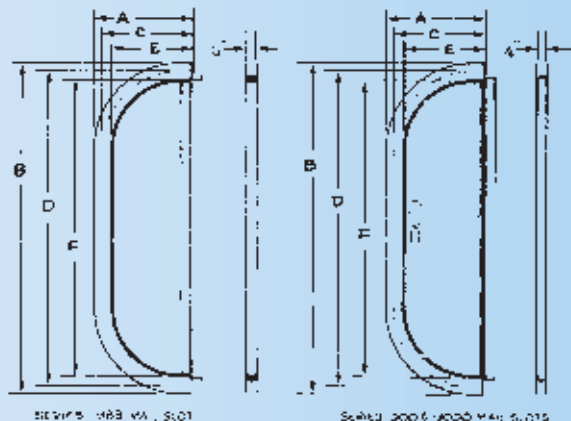

Slotted 3000-4-1000 MAIL SLOTS

Slotted 3000-6-1000 MAIL SLOTS

Speak Holes & Mail Slots

SPEAK HOLES

For 1/4", 1/2" Plate Glass,
1 3/4" Wood or Steel Doors

Features: Easy installation conceals glaze cut.

Materials: Heavy wrought aluminum 6063T5 with Anodized 204 R-1 Clear Alumilite finish No. 834-A. Series is available in stainless steel. No. 841

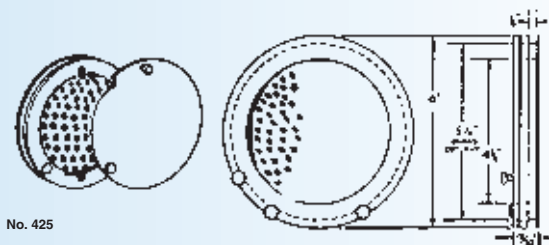
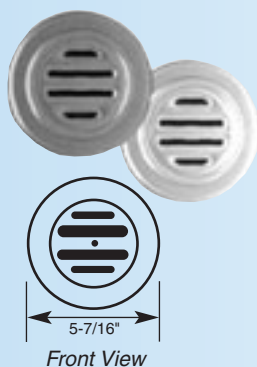

No. 425

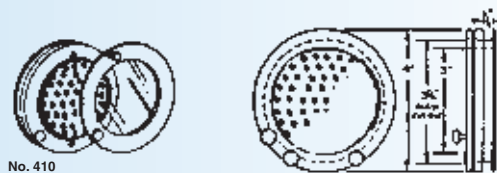

No. 410



No. 444



No. 510



No. 600-FR



No. 666

USE WITH RESISTANT GLAZING

No. 600 FR Talk Thru: Six inch diameter stainless steel talk thru has offset holes in front and rear to provide natural voice transmission. No. 600 FR Talk Thru is available as interior or exterior model (specify which). It fits glass from .25" to 1.875" thick.

Indicate glass thickness when ordering.

Construction: Stainless steel

Circular, Louvered, Stainless Steel Speak Hole:

Bullet resistant round 6" diameter speak hole offers natural voice transmission through cast stainless steel evenly spaced concentric louvers. No. 666

STOCK NO.	DIAMETER		GLASS Thickness	DESCRIPTION
	Outside	Inside		
405	4"	3"	1/4"	Screen & Metal Cover
410	4"	3"	1/4"	Screen & Lucite Cover
410-2	4"	3"	1/2"	Screen & Lucite Cover
410-4	4"	3"	*1 3/4"	Screen & Lucite Cover
415	4 1/2"	3 1/2"	1/4"	Screen & Lucite Cover
425	6"	4 1/2"	1/4"	Screen & Metal Cover
430	6"	4 1/2"	1/4"	Screen & Lucite Cover
444	4 1/2"	3"	1/4"	Louvre Type Opening
444-2	4 1/2"	3"	1/2"	Louvre Type Opening

*1 3/4" Wood or Steel Door

BULLET RESISTANT SPEAK HOLES STAINLESS STEEL				
510	5"		1 3/16"	
600-FR	6"		1/4" - 1 7/8"	
666	6"		1 3/16"	
ELECTRONIC TALK THROUGH SPEAK HOLE				
NIS-1A	5"		1/4" - 1 3/16"	
NIS-1D	5"		1/4" - 1 3/16"	





Steel Sliding Fire Windows

3/4 HR. FIRE RATED-ICC-ES APPROVED

- **Spring Activated Automatic Closures**
- **1/4" Polished Wire**
- **Nail-On or Masonry Type Frames**
- **Munting For Glass Not Exceeding 720 sq/in.**

Fire resistant rating of 45 minutes in wall construction of masonry, wood or steel studs per report number 2781, as tested under fire tests of window assemblies, A.S.T.M.E. 163-65 and National Fire Protection Association number 257-70.

Windows are manufactured with an automatic closing device. A spring actuated closer which operates with a 160 degree fusible link mounted on the interior side of the frame.

Material: Frame and sash members shall be fabricated of 16 gauge cold rolled steel, formed and assembled with 12 gauge gussets and 16 gauge angles. Material complies with ASTM A366.

Weatherstripping: Sliding sash panel shall be fully weatherstripped with silicone treated wool pile or equivalent and vinyl. Fixed panel is bed in sealed to insure full perimeter weather seal.

Finish: All steel frame and sash members shall be furnished with a primer coat on all surfaces, (Optional White or Bronze Finish) conforming to Underwriters Laboratory specifications.

Glazing: Windows to be factory glazed with clear 1/4" wire glass. Lites to have minimum of 24 gauge wire with maximum opening of one square inch per Underwriters Laboratory. Individual lites of glass shall not exceed 720 square inches each. Glass complies with ANSI Z97.1 and ASTM C1036.

Hardware: Sliding panels shall be furnished with a positive latching 1/8" thick steel latch, which is attached to the bottom rail. It engages on a 1/4" thick keeper that is surface mounted to the sill member. A spring actuated automatic closing device used in conjunction with a 160 degree fusible link assembly mounted on the unit. This assembly functions as a self closing latch.

Optional Screen: Screen shall be fabricated from 5/16" x 5/8" tubular rolled formed aluminum sections. Screen cloth shall be 18 x 16 aluminum mesh. Screen shall be fixed mounted to the interior of the window frame through the use of aluminum spring clips. When in place, the screen shall not interfere with the operation of the sliding panel or impede water drainage from the sill.

Installation: The installer shall set out all window frames in a level, plumb and square conditioned without distortion. Units shall be promptly caulked, flashed and anchored in accordance with good window installation practice.



		← WINDOW WIDTH →			
CALL OUT SIZE		3°	4°	5°	6°
↑ WINDOW HEIGHT ↓	ROUGH IN	36 1/2"	48 1/2"	60 1/2"	72 1/2"
	NET	36"	48"	60"	72"
2°	24 1/4" 24"				
3°	36 1/4" 36"				
4°	48 1/4" 48"				
5°	60 1/4" 60"				

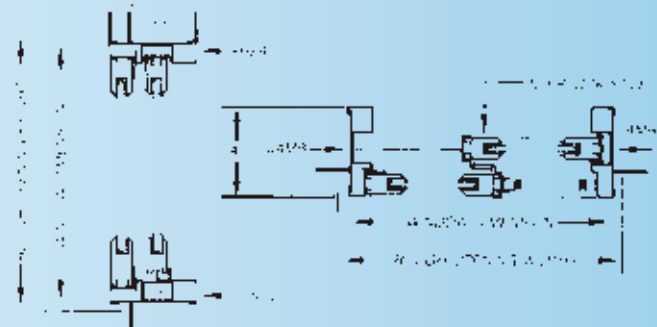

NISSEN & COMPANY, INC.

9508 Rush Street

South El Monte, California 91733-1574

(323) 723-3636 • (626) 579-5666

24 Hr. Fax Line (626) 579-0628

www.nissenco.com • nissenco@earthlink.net