

DELIVERY, STORAGE AND INSTALLATION INSTRUCTIONS FOR BLAST AND PRESSURE RESISTANT DOORS AND FRAMES

1. SCOPE

The intent of this document is to assist the installer in the recommended steps for receiving, storing and installing hollow metal frames and doors. This is not intended to cover specific situations and is to be used only as a guideline as it is assumed the installer has prior knowledge in performing this work.

2. DELIVERY

Upon receipt, all material should be inventoried and thoroughly inspected for damage and all wrapping should be removed to promote air circulation. Damaged or missing material should be immediately noted on the freight bill and reported to the freight carrier's office. Security Metal Products Corporation can assist in this process. Any damaged material signed for should be immediately reported to Security Metal Products Corporation as this will expedite the processing of a freight claim for repair or replacement. Corrective field work shall not be performed by the Customer unless authorized by Security Metal Products Corporation. Minor deviations from true form and alignment can and should be corrected by the installer.

3. STORAGE

Improper storage can result in damage, shop primer deterioration on metal surfaces and veneer deterioration on wood surfaces resulting in project delays. Water and humidity damage are probably the largest source of problems that can easily be avoided. All frames and doors need to be stored vertically on blocking at least four inches above the floor in a dry area, under cover, with at least ¼" airspace between to allow proper circulation. Caution should be exercised to avoid creating a humidity chamber..

Most paint manufacturers recommend that factory applied primer should receive a finish coat of paint within 30 days of delivery. All cleaning, sanding and touch up work prior to finish painting is the responsibility of others.

4. FRAME INSTALLATION

A. GENERAL

Welded door and window frames are checked at the factory to ensure they are square and without twist. Temporary steel spreader bars are then attached to the jamb bases to minimize misalignment or other damage during shipment. **These bars are for shipping purposes only and must be removed prior to frame installation.** At no time should a spreader bar be used to square a frame.

All hollow metal frames are manufactured to meet published manufacturing tolerances which can be found in NAAMM/HMMA 841 and SDI-117. Published installation tolerances should be followed by the installer and can be found in NAAMM/HMMA 840 and SDI-122.

Prior to installation the installer is to ensure the frames are properly identified and are the appropriate swing, size, depth and in the case of fire rated openings, are marked with the proper fire rating label.

B. ANCHORS

Several types of anchors are available to suit various wall and floor conditions. These are masonry wall anchors, metal stud wall anchors, wood stud wall anchors, existing masonry or concrete wall anchors and floor anchors (Figures 1 thru 8).

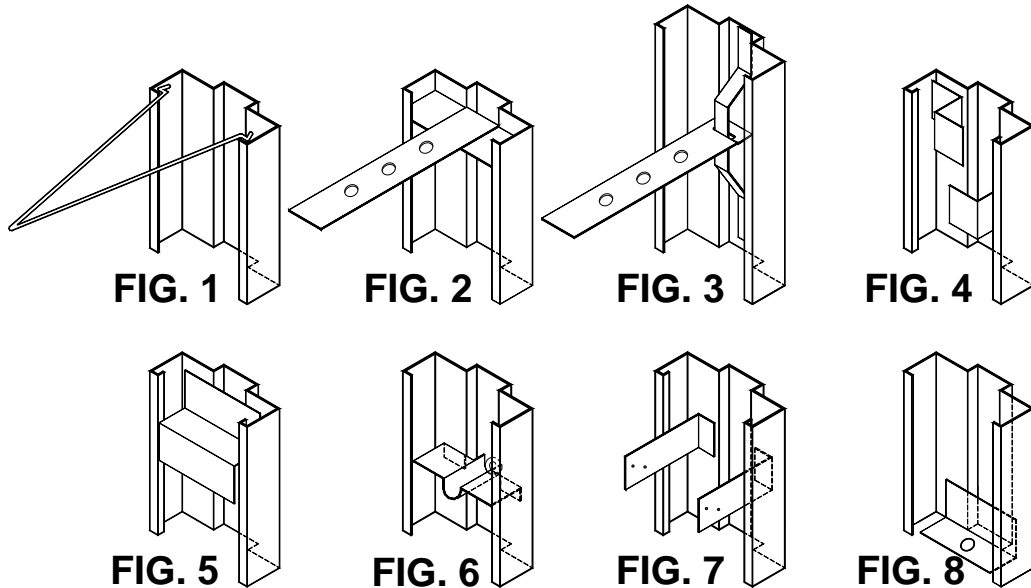

C. REQUIREMENTS

The installer should have a carpenter level, a square, and a sufficient quantity of wood spreaders and braces. Set the frame in the desired location and level the header. Square the jambs to the header. Shim under the jambs if necessary. With the frame properly aligned, insert wood spreaders at the floor and mid height of the frame and fasten the frame to the floor through the floor anchors provided. Brace the frame vertically from either side with additional notched wood braces or shore to the structure above. Do not brace in the direction of the intended wall. Plumb and square the jambs. Note that frames over 4'-0" in width may require an additional vertical wood brace support at mid point (Figures 9 and 10).

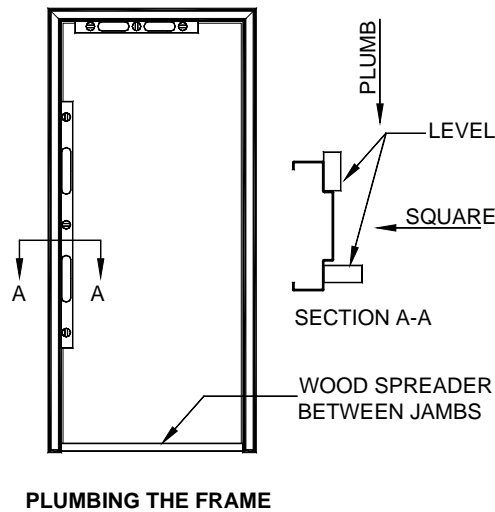

FIG. 9

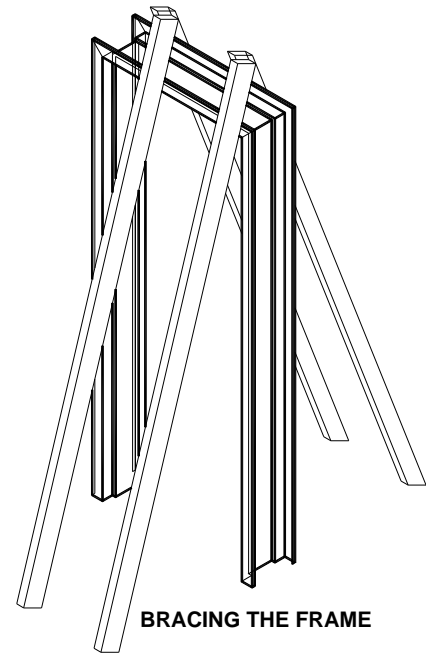
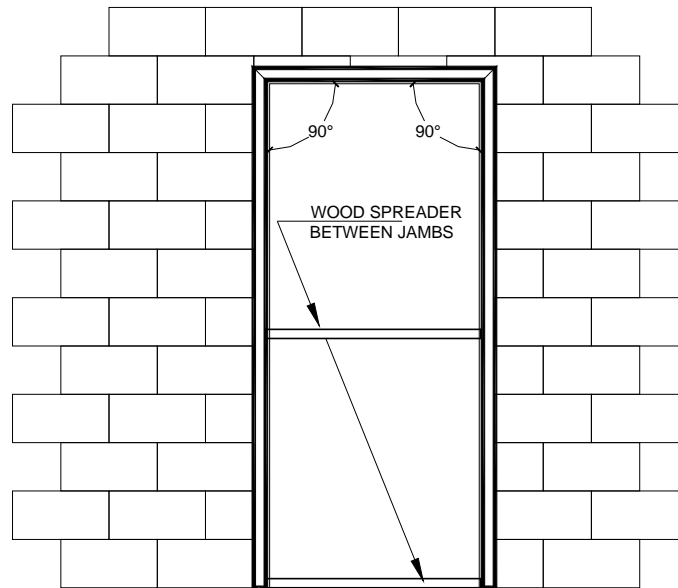

FIG. 10

Wood spreaders must be square and made from lumber no less than 1" thick. Correct length is the door opening width between the jambs at the header. The spreader should be nearly as wide as the jamb depth and notched for the frame stops. Do not remove these spreaders until the frames are set permanently in the wall.

D. INSTALLATION IN NEW MASONRY WALLS

As the wall is erected, locate the jamb anchors at the hinge locations in the hinge jamb and in the corresponding locations in the opposite jamb. Fully grout the frame and check plumb, square and twist as the wall progresses. Head anchors are not normally provided in this type of installation (Figure 11).



NEW MASONRY WALL CONSTRUCTION

FIG. 11

E. INSTALLATION IN EXISTING MASONRY WALLS

This instruction assumes masonry walls are erected prior to arrival of the hollow metal frames. The rough opening should have approximately 3/16" perimeter clearance over the overall frame size. Slide the frame into the opening and install the wood spreaders. Install tapered wood shims between the wall and the frame at each anchor position to maintain squareness and alignment. Drill the appropriate size hole for anchor bolts (provided by others) into the masonry through the holes provided in the frame and the metal spacer behind. Insert the anchor bolts and tighten securely, periodically checking for frame alignment. Insert backer rod and caulking where necessary where gaps occur between the frame and wall (Figure 12).

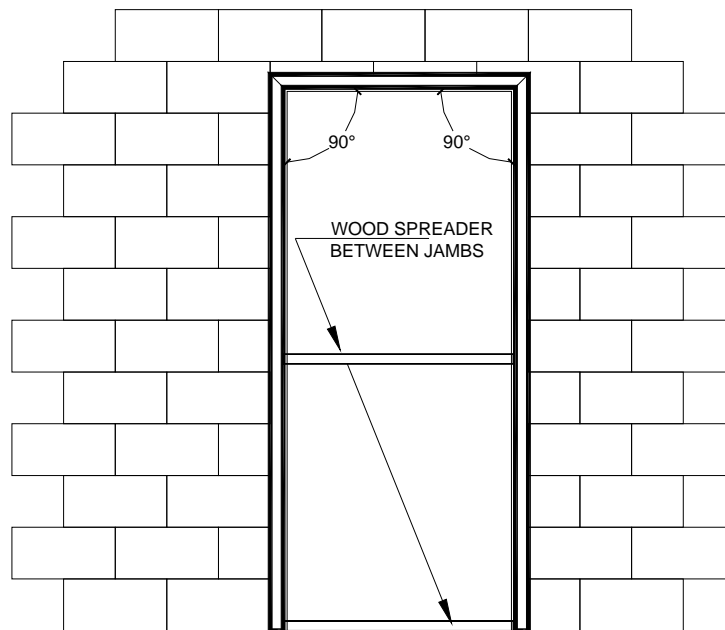

EXISTING MASONRY WALL CONSTRUCTION

FIG. 12

F. INSTALLATION IN STEEL STUD WALLS

Double studding of proper thickness is recommended for this installation. Install the jamb studs to the floor, header channels and ceiling runners butted tightly against the frame anchors and properly positioned in the frame throat for wallboard. Nesting or overlapping studs which will increase the wall thickness should be avoided. Using two screws per anchor fasten through the stud into the anchor. Screws should be sheet metal or self tapping and minimum #6 x 3/8" long. Continually check plumb, square and twist as the installation progresses (Figure 13).

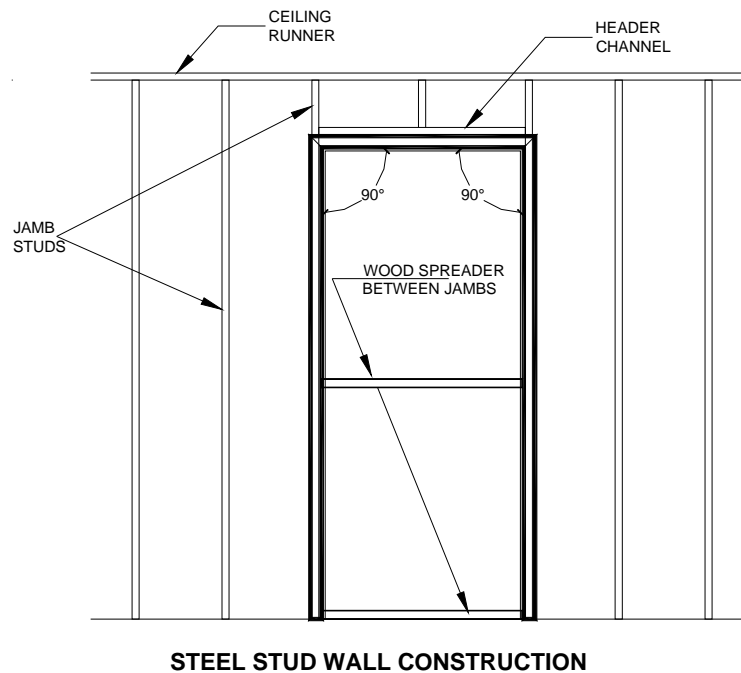
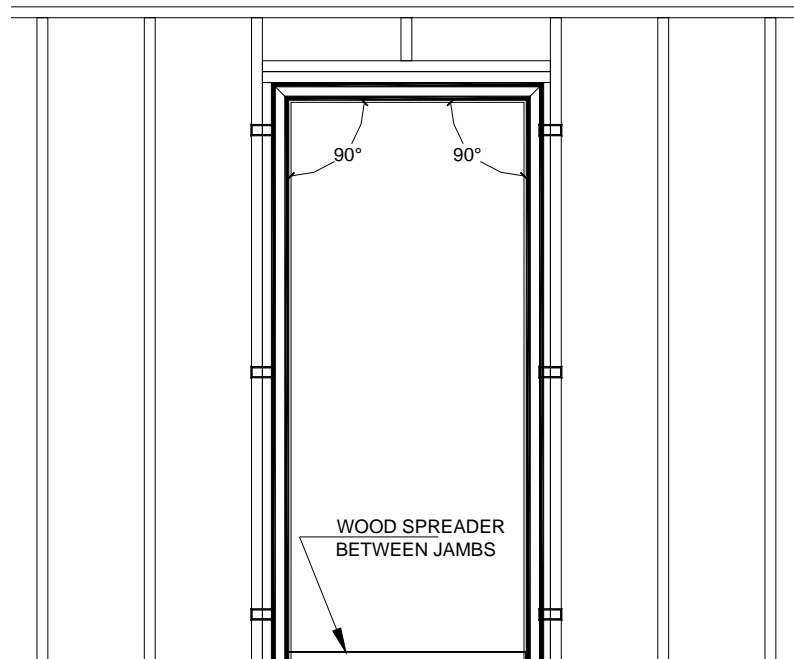

FIG. 13

G. INSTALLATION IN WOOD STUD WALLS

This instruction assumes wood stud framing is erected prior to arrival of the hollow metal frames. As with metal stud walls, double studding is recommended. Wood stud framing should have approximately ¼" perimeter clearance over the overall frame size. The anchor straps should be bent out of the frame throat to allow installation within the framed opening after which the straps should be bent around the studs leaving sufficient room for the wallboard. Square and nail the top anchor to the stud on one jamb only. Check plumb, square and twist and then continue to nail the balance of anchors. Repeat on the opposite jamb and then the header. Use two nails per strap and minimum 8D nails (Figure 14).



WOOD STUD WALL CONSTRUCTION

FIG. 14

H. FRAME INSTALLATION TOLERANCES

Installation tolerances with respect to square, plumb, alignment and twist are permitted as long as they are within the guidelines published in NAAMM/HMMA 840 and SDI-122. It should be noted that the cumulative effect of those tolerances is not acceptable and will result in misalignment and improper functioning of hardware and doors.

5. DOOR INSTALLATION

A. GENERAL

In general, all doors are reinforced, drilled and tapped at the factory for fully templated mortised hardware. Preparation for surface mounted hardware, anchor hinges, pivot reinforced hinges, thrust pivot hinges or any other non-templated mortised hardware will consist of reinforcing only for field preparation by others. Industry standard door to frame and door to floor clearances are identical to those published in ANSI/NFPA 80 for fire rated assemblies. In view of the acceptable manufacturing and installation tolerances, it may be necessary to use hinge shims in order to achieve uniform clearance and/or alleviate hinge bind and examples of how to do this are shown in NAAMM/HMMA 840 and SDI-122. All doors should be hung and fully adjusted prior to application of finish paint to avoid unnecessary damage to the paint.