



**ALACO**  
Ladder Company

888-310-7040 www.alacoladder.com

## Loft Ladder Fax Back Estimate Form

When completed, fax all 3 pages to 909-591-7565

**How to order or get an estimate on your ladder**  
Complete all the information and fax back all 3 pages.  
We will contact you with an estimate or to arrange delivery of your Loft Ladder and Track.

Contact \_\_\_\_\_

Company \_\_\_\_\_

Address \_\_\_\_\_

City \_\_\_\_\_ State \_\_\_\_\_ Zip \_\_\_\_\_

Phone \_\_\_\_\_ Fax \_\_\_\_\_

Email \_\_\_\_\_

### 1. Make Ladder Choices

Check all boxes that apply.

#### Specify Ladder

**Rolling Ladder (S-100)**

Ladder includes upper roller assembly or hook assembly, track and lower wheel assembly. Also pivots against wall when not in use.

**Pivotal Ladder (S-200)**

No lower wheels. Ladder pivots from wall with pivotal bracket assembly.

**Fixed Ladder (S-300)**

Fixed ladder that neither pivots nor rolls.

#### Specify Material

**Material:**

Wood  Aluminum

**Wood Type:**

Birch  Cherry  Mahogany  
 Maple  Red Oak  White Oak  
 Walnut  Alder  Specify Other: \_\_\_\_\_

**Wood Finish:**

Unfinished  Clear Finish  Gloss  Satin  
 Specify Minwax Stain: \_\_\_\_\_

**Aluminum Ladder:**

Aluminum loft ladders come standard with no finish. Ladders can be powdercoated in the following standard colors. Optional colors are also available.

Matte Black  Gloss Black  Beige Metallic  
 Matte White  Gloss White  Specify Other: \_\_\_\_\_

#### Specify Handrails

Handrails do not come standard.

**Flush Handrails:**

Left Side  
 Right Side  
 Both Sides

**Extended Handrails:**

Left Side  
 Right Side  
 Both Sides

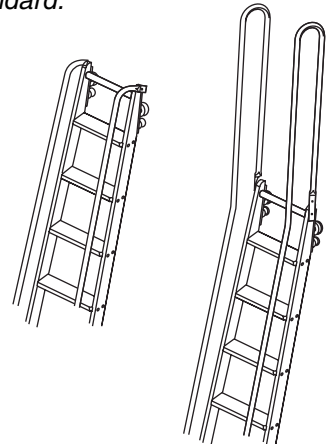

#### Specify Wheel Housing

S-100 Rolling Only.

**Sunburst Pattern**  
(Wood only)

**Contemporary**  
 Aluminum  
 Wood

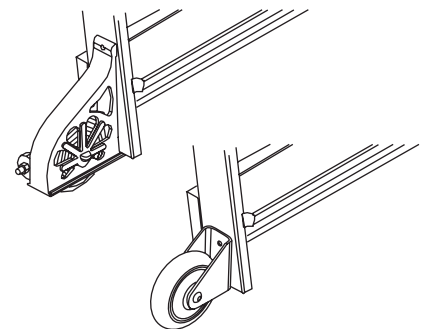



***Specify Hardware Finish***

All hardware, including wheel housing, upper roller assembly, handrails, metal track (if ordered), brackets, braces and bolts will be done in this finish.

- Chrome:     Polished     Satin
- Nickel:     Polished     Satin     Antique  
               Polished Black
- Copper:     Polished     Satin     Antique
- Brass:       Polished     Satin     Antique  
               Heavy/No Lacquer
- Bronze:     Antique/Oil Rub
- Powdercoated Finishes:
  - Matte Black       Gloss Black
  - Matte White      Gloss White
  - Beige Metallic

***Specify Upper Assembly***

*S•100 Rolling Only.*

- Roller Assembly**  
For affixed rolling ladder.

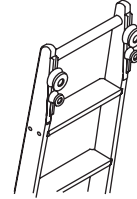

- Hook Assembly**  
For a removable ladder.

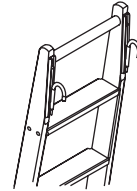

- Optional Safety Tread**  
No-slip tread added to all steps  
(wood only)

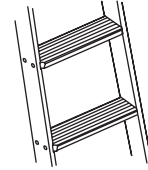

**2. Make Track & Bracket Choices**

Check the box that applies.  
See Step 3 for specifying Curved Tracks.

***For Steel Tracks***

*S•100 Rolling Only.*

Track and brackets to match specified hardware finish.  
Brackets must be mounted no more than every 48”.

- Vertical Brackets for Ladders  
with Roller Assembly**

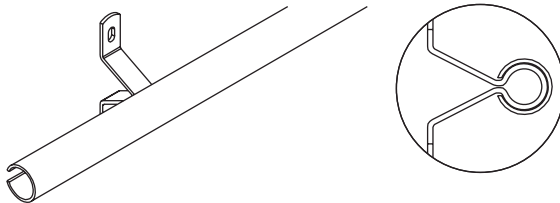

- Vertical Brackets for Ladders  
with J Hook Assembly**

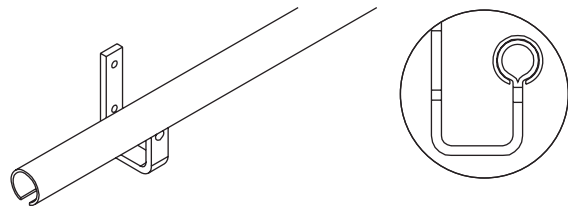



### 3. Provide Dimensions

Fill in all dimensions that apply.

#### Loft Ladder Dimensions

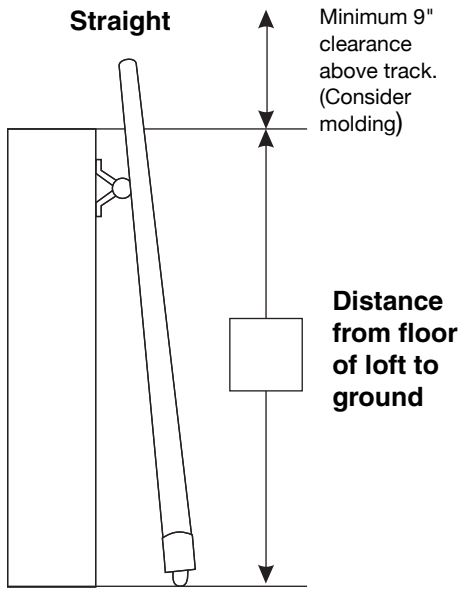

Number of brackets supplied will be based on 30" spacing.

- Check here if mounting surfaces require more brackets.
- If you would like ALACO to assist you in figuring your dimensions, please check this box and fax us a separate sketch of your room or floor plans.

#### Track Dimensions

