



# ALACO Ladder Company

888-310-7040 www.alacoladder.com  
Fax - 909-591-7565  
Email - sales@alacoladder.com

## Loft Ladder Estimate Form

**How to order or get an estimate on your ladder**  
Complete all the information on this form and email or fax back all 3 pages.

We will contact you with an estimate or to arrange delivery of your Loft Ladder and Track.

### 1. Make Ladder Choices

Check all boxes that apply.

#### Specify Ladder

##### Rolling Ladder (S-100)

Ladder includes upper roller assembly or hook assembly, track and lower wheel assembly. Also pivots against wall when not in use.

##### Pivotal Ladder (S-200)

No lower wheels. Ladder pivots from wall with pivotal bracket assembly.

##### Fixed Ladder (S-300)

Fixed ladder that neither pivots nor rolls.

#### Specify Material

##### Material:

Wood      Aluminum

##### Wood Type:

Birch      Cherry      Mahogany  
Maple      Red Oak      White Oak  
Walnut      Alder      Specify Other: \_\_\_\_\_

##### Wood Finish:

Unfinished      Clear      Stain to Match  
Specify Minwax Stain: \_\_\_\_\_

**Wood Finish also select:**      Gloss      Satin

##### Aluminum Ladder:

Aluminum loft ladders come standard with no finish. Ladders can be powdercoated in the following standard colors. Optional colors are also available.

Matte Black      Gloss Black      Beige Metallic  
Matte White      Gloss White      Specify Other: \_\_\_\_\_

Contact \_\_\_\_\_

Company \_\_\_\_\_

Address \_\_\_\_\_

City \_\_\_\_\_ State \_\_\_\_\_ Zip \_\_\_\_\_

Phone \_\_\_\_\_ Fax \_\_\_\_\_

Email \_\_\_\_\_

#### Specify Handrails

Handrails do not come standard.

##### Flush Handrails:

Left Side  
Right Side  
Both Sides

##### Extended Handrails:

Left Side  
Right Side  
Both Sides

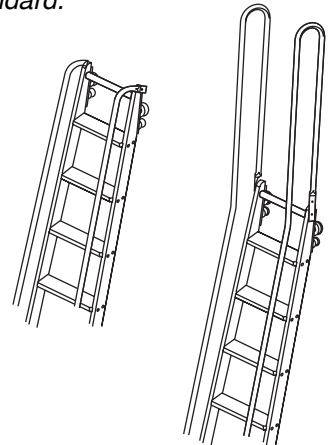

#### Specify Wheel Housing

S-100 Rolling Only.

##### Sunburst Pattern (Wood only)

Contemporary  
Aluminum  
Wood

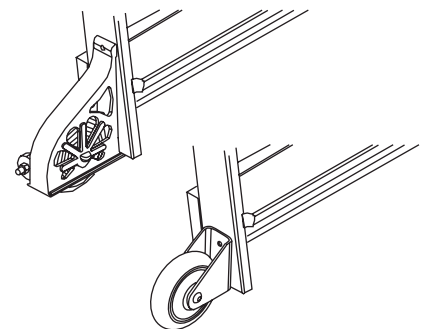



# ALACO Ladder Company

888-310-7040 www.alacoladder.com  
Fax - 909-591-7565  
Email - sales@alacoladder.com

## Loft Ladder Estimate Form

### Specify Hardware Finish

All hardware, including wheel housing, upper roller assembly, handrails, metal track (if ordered), brackets, braces and bolts will be done in this finish.

Chrome:	Polished	Satin	
Nickel:	Polished	Satin	Antique
	Polished Black		
Copper:	Polished	Satin	Antique
Brass:	Polished	Satin	Antique
	Heavy/No Lacquer		
Bronze:	Antique/Oil Rub		
Powdercoated Finishes:			
	Matte Black	Gloss Black	
	Matte White	Gloss White	
	Beige Metallic		

### Specify Upper Assembly

S-100 Rolling Only.

**Roller Assembly**  
For affixed rolling ladder.

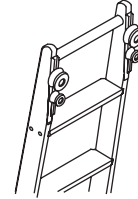

**Hook Assembly**  
For a removable ladder.

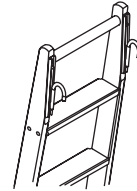

**Optional Safety Tread**  
No-slip tread added to all steps  
(wood only)

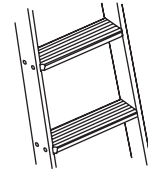

## 2. Make Track & Bracket Choices

Check the box that applies.  
See Step 3 for specifying Curved Tracks.

### For Steel Tracks

S-100 Rolling Only.

Track and brackets to match specified hardware finish.  
Brackets must be mounted no more than every 48".

**Vertical Brackets for Ladders  
with Roller Assembly**

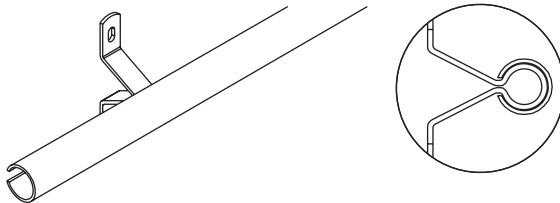

**Vertical Brackets for Ladders  
with J Hook Assembly**

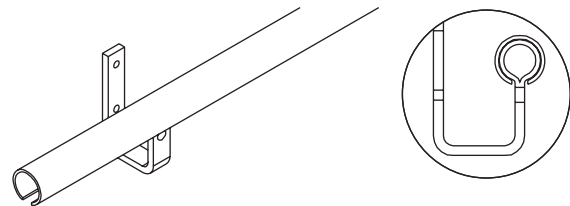



# ALACO Ladder Company

888-310-7040 www.alacoladder.com  
Fax - 909-591-7565  
Email - sales@alacoladder.com

## Loft Ladder Estimate Form

### 3. Provide Dimensions

Fill in all dimensions that apply.

#### Loft Ladder Dimensions

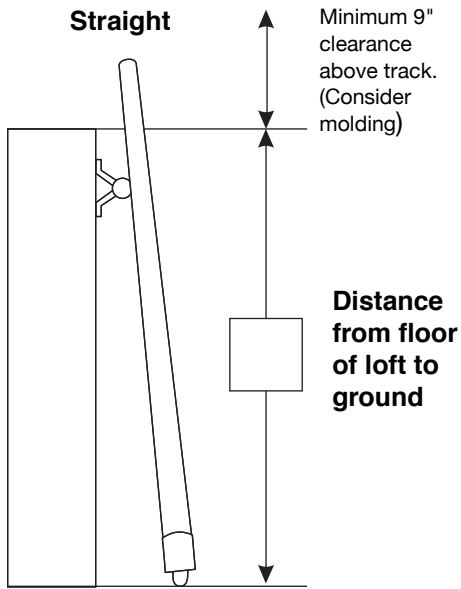

Number of brackets supplied will be based on 30" spacing.

Check here if mounting surfaces require more brackets.

If you would like ALACO to assist you in figuring your dimensions, please check this box and fax us a separate sketch of your room or floor plans.

#### Track Dimensions

