



### DOUBLE LEAF SPECIFICATIONS

NO CHANGES WITHOUT PRIOR UL NOTIFICATION AND FM APPROVAL

- COVER: 14 GAUGE GALVANIZED STEEL
- LINER: 12 GAUGE GALVANIZED STEEL
- INTERIOR CURB: 12 GAUGE GALVANIZED STEEL
- EXTERIOR CURB: 14 GAUGE GALVANIZED STEEL
- SPRING: HIGH PRESSURE GAS SPRINGS OPEN COVERS AGAINST 10 PSF SNOW OR WIND LOAD
- COVER IS STIFFENED TO WITHSTAND A LIVE LOAD OF 40PSF WITH A MAX DEFLECTION OF 1/150 OF THE SPAN

- HARDWARE: ZINC PLATED STEEL
- LATCH: TANDEM ZINC PLATED PYROLATCHES WITH INSIDE AND OUTSIDE RELEASE HANDLE AND AN AUTOMATIC RELEASE MECHANISM ASSISTED WITH 165° FUSIBLE LINKS. DESIGNED TO HOLD COVERS CLOSED AGAINST A 105 PSF WIND UPLIFT.
- HINGE: ZINC PLATED STEEL TAMPER PROOF HINGE CONTAINED WITHIN HATCH AS PART OF SPRING ASSEMBLY

- INSULATION: 3" THICK ACOUSTIC INSULATION IN COVER AND 1.75" ON CURB PERIMETER
- STC RATING: **45**
- OITC RATING: **37**
- HOLD OPEN ARM: ZINC PLATED STEEL
- FINISH: POWDER COAT PAINT

SIZE(S) AVAILABLE (WIDTH X LENGTH)
UL LISTED SIZES
SIZES WITHIN RANGE
48 X 48 TO 72 X 96 INCHES
FM APPROVED SIZES
SIZES WITHIN RANGE
48 X 48 TO 72 X 120 INCHES

\*WIDTH AND LENGTH DIMENSIONS ARE FROM THE INSIDE FACE OF CURB TO INSIDE FACE OF CURB  
 \*EFFECTIVE VENTING AREA = 80% W X L

General shop drawing - NOT TO SCALE

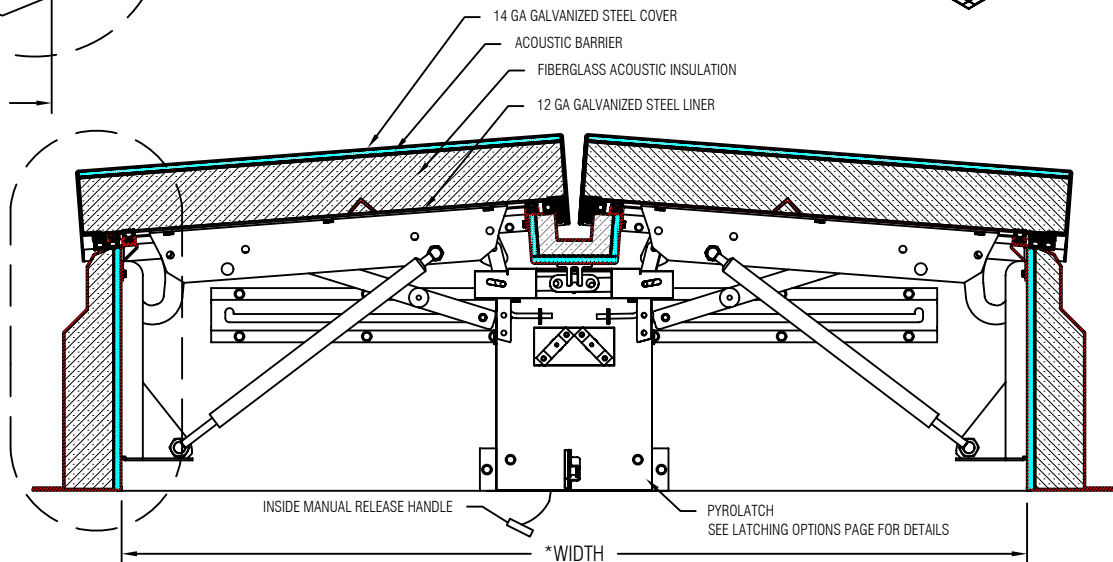
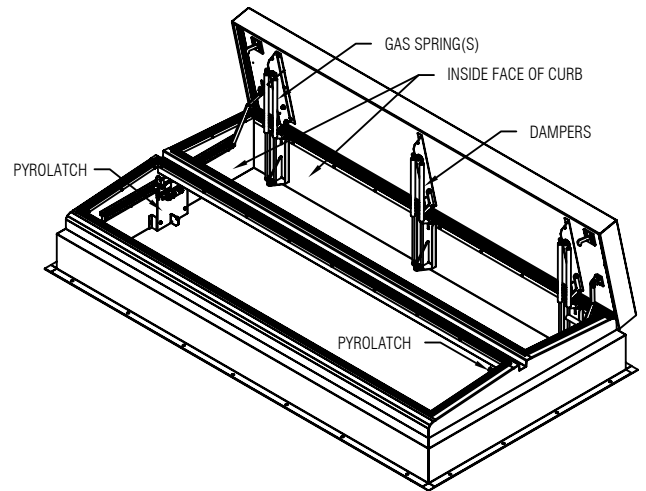
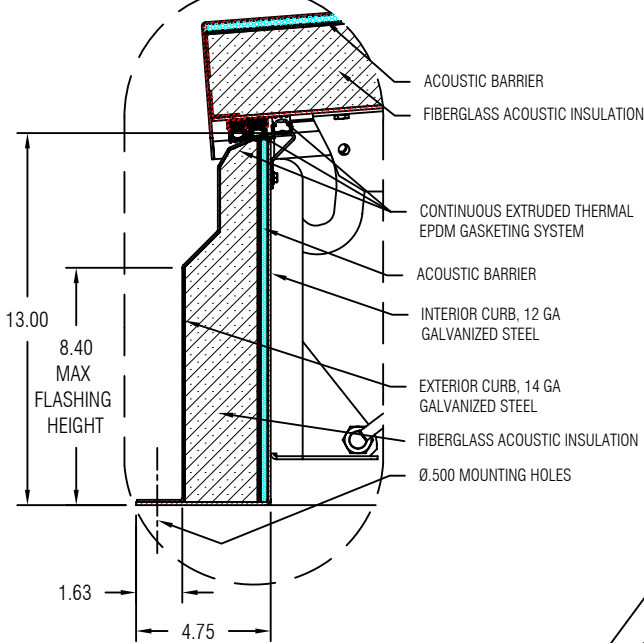

SIZE- WIDTH:	LENGTH:
INCHES	INCHES

**PYROLATCH OPTIONS**

**PYROLATCHES(QTY 2) WITH THERMAL FUSIBLE LINKS.**

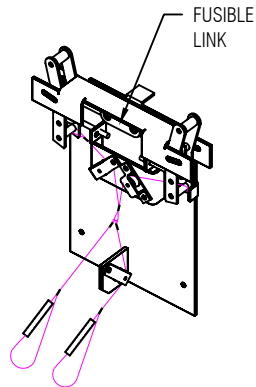
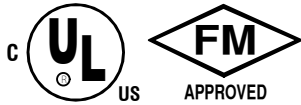

**OPENING METHOD**

- **MANUAL**  
EXTERNAL PULL AND INTERNAL PULL  
(10 FT OF CABLE PROVIDED)
- **THERMAL VIA FUSIBLE LINKS**
  - 165°F (standard)
  - 212°F
  - 350°F

**CLOSING METHOD**

- SMOKE VENT COVERS MANUALLY CLOSED FROM THE EXTERIOR AT ROOFTOP
- REPLACE MELTED FUSIBLE LINKS AT SMOKE VENT LOCATION SMOKE VENT COVERS MANUALLY CLOSED FROM THE EXTERIOR AT ROOFTOP

**PYROLATCHES WITH MC CABE THERMAL/ELECTRICAL LINKS (QTY 2 REQUIRED)**

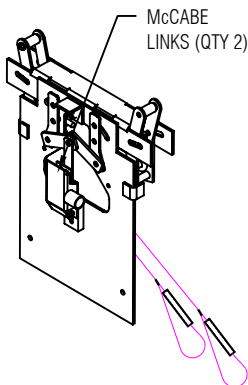
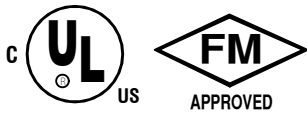

**OPENING METHOD**

- **MANUAL**  
EXTERNAL PULL AND INTERNAL PULL  
(10 FT OF CABLE PROVIDED)
- **THERMAL VIA McCABE LINKS**
  - 165°F (standard)
  - 212°F
- **ELECTRICAL VIA McCABE LINK**  
OPENS VENT WITH AN ELECTRICAL SIGNAL FROM A FIRE ALARM, SMOKE DETECTOR, HEAT DETECTOR, SPRINKLER WATER FLOW SWITCH OR OTHER MEANS OF DETECTION (TIME DELAY UP TO 45 SECONDS)
  - 24V AC/DC, 2.3 AMPS EACH, 4.6 AMPS TOTAL PER SMOKE VENT(standard)
  - 110V AC/DC, .46 AMPS EACH, .92 AMPS TOTAL PER SMOKE VENT
  - 230V AC/DC, .23 AMPS EACH, .46 AMPS TOTAL PER SMOKE VENT

**CLOSING METHOD**

- SMOKE VENT COVERS MANUALLY CLOSED FROM THE EXTERIOR AT ROOFTOP
- RESET McCABE LINKS AT SMOKE VENT LOCATION, SMOKE VENT COVERS MANUALLY CLOSED FROM THE EXTERIOR AT ROOFTOP
- RESET McCABE LINKS AT SMOKE VENT LOCATION, SMOKE VENT COVERS MANUALLY CLOSED FROM THE EXTERIOR AT ROOFTOP

THIS REVIEW IS ONLY FOR GENERAL CONFORMANCE WITH THE DESIGN INTENT AND THE INFORMATION GIVEN IN THE CONSTRUCTION DOCUMENTS. COMMENTS MADE IN THE SHOP DRAWINGS DURING THIS REVIEW DO NOT RELIEVE THE CONTRACTOR FROM COMPLIANCE WITH THE REQUIREMENTS OF THE PLANS AND SPECIFICATIONS. REVIEW OF A SPECIFIC ITEM IS SHALL NOT IMPLY REVIEW OF AN ASSEMBLY OF WHICH THE ITEM IS A COMPONENT. THE CONTRACTOR IS RESPONSIBLE FOR DIMENSIONS AND QUANTITIES REQUIRED TO BE CONFIRMED AND CORRELATE'S THE JOB SITE ; INFORMATION THAT PERTAINS SOLELY TO THE FABRICATION PROCESS OR TO THE MEANS, METHODS, TECHNIQUES, SEQUENCES AND PROCEDURES OF CONSTRUCTION; COORDINATION IF THE WORK WITH THAT OF ALL OTHER TRADES, AND PERFORMING ALL WORK IN A SAFE AND SATISFACTORY MANNER.

- NO EXCEPTION TAKEN
- REVISE AND RESUBMIT
- NOTE COMMENTS
- REJECTED

SIGNATURE REQUIRED

DATE