



Electric Strikes

DORMA ES-110

Rugged quality, performance, and high security make the ES-110 Series the unanimous choice for integrating into an access control system.

The ES-110 Series electric strikes with the ANSI configuration provide a unique versatility with the interchangeable face plates to accommodate new or existing cylindrical and mortise lock applications.

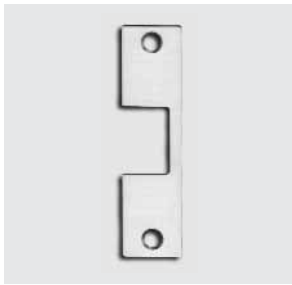

ES-111 - For use with cylindrical and narrow stile locksets with 1/2" to 3/4" throw. Installs into the standard ANSI A115.1 frame cutout with face of frame modified. Releases the latch bolt; relocks upon closing.

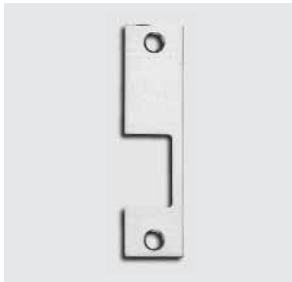

ES-112 - For use with mortise locksets with latch bolt or latch bolt and deadlocking latch. Installs into the standard ANSI A115.1 frame cutout with face of frame modified. Releases the latch bolt; relocks upon closing.

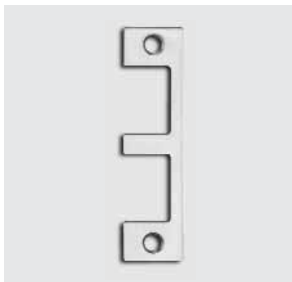

ES-113 - For use with combination latch and dead bolt mortise locksets. Installs into the standard ANSI A115.1 frame cutout with face of frame modified. Releases the latch bolt, but does not release the door when dead bolt is extended.

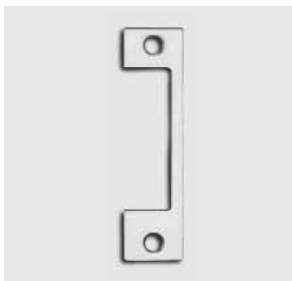

ES-114 - For use with normally extended dead bolt-only locksets, with or without latch bolt and/or dead latch. Installs into the standard ANSI A115.1 frame cutout with face of frame modified. Releases the dead bolt to allow the door to be opened; captures dead bolt and relocks the door upon closure.



Technical Details:

- In-board solenoid design eliminates the possibility of casual contact with a hot surface when energized continuously.
- Fits ANSI A115.1 prep with simple modification of frame face.
- Fits narrow 1-3/4" aluminum or hollow metal frame.
- Non-handed, interchangeable faceplates to accommodate various types of locks.
- Fail secure model releases door with side load pressure up to 20 lb.
- Easy horizontal adjustments to compensate for door position.
- Optional indication switches for monitoring status of locking latches and bolts.
- Tamper-resistant, extra heavy-duty cast construction.
- Corrosion-resistant metals - The case and working parts are investment-cast stainless steel.
- Remote electric operation - The electric strike can be operated by a variety of switches or card access devices.
- Solenoid actuated. All solenoids are rated for continuous duty operation and exceed ANSI/BHMA standards.
- Faceplates are heavy gauge with modular design, allowing compatibility with a majority of security hardware.
- Plug connector is a two part electrical connector which permits field wiring prior to installation. Also allows the strike to be removed without disturbing field wiring.

Options:

LBM - This switch monitors the latch bolt and indicates whether or not it is extended into the electric strike (not available in model 114).

LCM - This switch monitors the locking cam and indicates whether or not the latch bolt keeper is locked in place.

LCMLBM - Two switches. One monitors the latch bolt and the other monitors the locking cam. Together, they indicate that the latch bolt is extended into the electric strike and that the latch bolt keeper is locked in place¹ (not available in model 114).

LCBDM - This switch combination monitors the latch bolt, locking cam, and dead bolt. It indicates that the latch bolt is extended into the electric strike, that the latch bolt keeper is locked in place, and whether or not the dead bolt is extended into the electric strike² (available for model 113 only).

DBS - Monitors the dead bolt location and indicates whether it is extended into the electric strike or retracted.

FS - Fail safe strikes (non-U.L.).

BR64XL - Bridge rectifier.

MT - Mounting tabs.

Certifications:**Burglary Protection Equipment:**

Underwriters Laboratories Inc., Standard No. UL1034.

American National Standards Institute, Inc., Standard No. ANSI/UL 1034.

Fire Door Accessories:

Underwriters Laboratories, Inc., Standard No. UL10B

American Society for Testing and Materials, Standard Method ASTM E 152.³

National Fire Protection Association, Standard Method NFPA 252.5.

Auxiliary Locks and Associated Products:

The DORMA ES-110 Series conforms to the requirements of ANSI/BHMA 156.5 1992, Grade 1.

Electrical Specifications:

Solenoid Operating Voltages: .30 A @ 12 VDC, .15 A @ 24 VDC.

Monitoring Switches: SPDT 5 A @ 125 or 24 VAC.

Warranty: One Year

Face Plate Finishes:**Standard Finish:**

Stainless: 630 (Satin).

Optional Plated Finishes:

Brass: 605 (Bright) or 606 (Satin).

Bronze: 611 (Bright), 612 (Satin), or 613 (Dark Oxidized Satin).

Chrome: 625 (Bright) or 626 (Satin).

Stainless: 629 (Bright).

CAUTION: The fail-safe operating action is not permitted for use on U.L.-labeled fire doors.

NOTES:

1. A switch tripper is added into the keeper area of the electric strike and is activated by the latch bolt/dead bolt of the locking hardware. When the door is open, this switch tripper can be manually depressed, thereby giving a false signal that the door is locked. This false signal can be eliminated by adding a door position indication switch to the door opening and wiring it together with the indication switch(es) in the electric strike.
2. A switch tripper is added into the dead bolt cavity of the electric strike and is activated by the dead bolt of the locking

hardware. When the door is open, this switch tripper can be manually depressed, thereby giving a false signal that the door is locked. This false signal can be eliminated by adding a door position indication switch to the door opening and wiring it together with the indication switch(es) in the electric strike.

3. Compliance with both ASTM E 152 and NFPA 252 standards are indicated in our UL10B report.

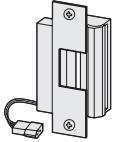
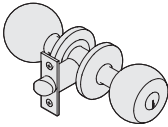
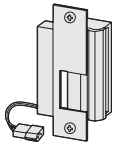
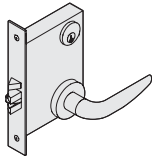
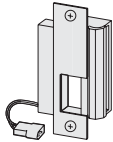
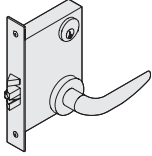
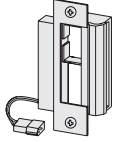
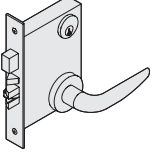
Model	Lock Type	Compatible Lock Manufacturer	Strike Operation	Cross Reference
ES-111-A 	 <p>For use with dead latch and cylindrical locksets (does not require a relocation of center line).</p>	ANSI and compatible narrow stile locks, all bored (cylindrical) locksets with 1/2" or 5/8" latch bolts, including DORMA 800/700/600 Series. Adams Rite 4720.	After releasing the latch bolt, the keeper returns to the locked position.	HES 1003 J Adams Rite 7810/7820 Adams Rite 7901 Locknetics 90 J Rutherford 2114 Folger Adams 642 CYL Von Duprin 6211 SDC - 51A
ES-112-B 	 <p>For use with mortise locksets and mortise panic devices with or without a dead latch (does not require a relocation of center line).</p>	DORMA 9000 Series without Dead Bolt Corbin Russwin Falcon Folger Adams Accurate Baldwin Marks OMNIA PDQ Arrow Best	After releasing the latch bolt, the keeper returns to the locked position.	HES 1003 K Locknetics 90 K Rutherford 2124 Folger Adams 652 RFL Adams Rite 7904 Von Duprin 6211 SDC - 52B
ES-112-C 	 <p>For use with mortise locksets and mortise panic devices with or without a dead latch (does not require a relocation of center line).</p>	Sargent Yale Schlage	After releasing the latch bolt, the keeper returns to the locked position.	HES 1003 KD Locknetics 90 KD Rutherford 2134 Folger Adams 652 SYL Adams Rite 7902 Von Duprin 6211 SDC - 52C
ES-113-D 	 <p>For use with mortise locksets where the dead bolt is not released.</p>	DORMA 9000 Series with Dead Bolt Corbin Russwin Falcon Folger Adams Accurate Baldwin Marks OMNIA PDQ Arrow Best	When the dead bolt is projected manually, the strike will not release. When the dead bolt is retracted, access is accomplished by electrically releasing the keeper.	HES 1003 H Locknetics 90 H Rutherford N/A Folger Adams 662 RFD Adams Rite N/A SDC - 53D

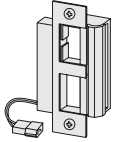
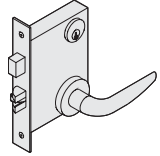
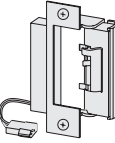
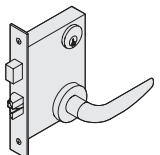
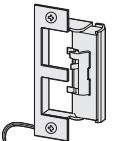
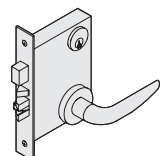
Model	Lock Type	Compatible Lock Manufacturer	Strike Operation	Cross Reference
<p>ES-113-F</p> 	 <p>For use with mortise locksets where the dead bolt is not released.</p>	<p>Schlage Yale Sargent</p>	<p>When the dead bolt is projected manually, the strike will not release. When the dead bolt is retracted, access is accomplished by electrically releasing the keeper.</p>	<p>HES 1003 HD Locknetics 90 HD Rutherford N/A Folger Adams 662 SSD Adams Rite N/A SDC - 53F</p>
<p>ES-114-D</p> 	 <p>For use with mortise locksets with a normally extended 1" dead bolt where lockset is released, recaptured, and contained.</p>	<p>DORMA 9000 Series with Dead Bolt Corbin Russwin Falcon Folger Adams Accurate Baldwin Marks OMNIA PDQ Arrow Best</p>	<p>Both latch bolt and dead bolt are released by a single keeper. Keeper is held open after bolts are released. Door may be closed with dead bolt extended. Keeper returns to locked when bolts re-enter strike.</p>	<p>HES 1003 A Locknetics 90 A Rutherford N/A Folger Adams 672 RFD Adams Rite N/A SDC - 54D</p>
<p>ES-114-F</p> 	 <p>For use with mortise locksets with a normally extended 1" dead bolt where lockset is released, recaptured, and contained.</p>	<p>Schlage Yale Sargent</p>	<p>Both latch bolt and dead bolt are released by a single keeper. Keeper is held open after bolts are released. Door may be closed with dead bolt extended. Keeper returns to locked when bolts re-enter strike.</p>	<p>HES 1003 AD Locknetics 90 AD Rutherford N/A Folger Adams 672 SSD Adams Rite N/A SDC - 54F</p>

Comparison is based on information obtained from trade sources. It is our judgement that these products are most similar. Exact equivalency is not guaranteed. Consult factory for details.

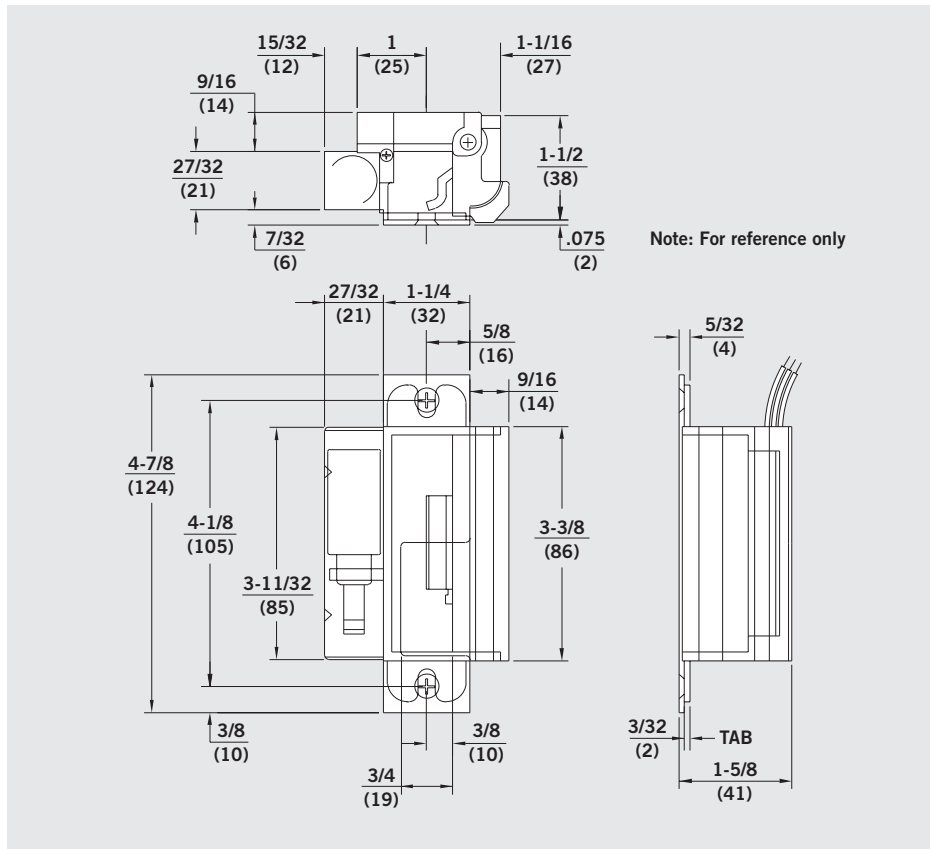

DORMA Group
North America
 www.dorma-usa.com

DORMA Architectural Hardware
 DORMA Drive, Drawer AC
 Reamstown, PA 17567-0411
 Telephone: (800) 523-8483
 Facsimile: (800) 274-9724
 E-mail: archdhw@dorma-usa.com

DORMA Canada
 1680 Courtney Park Drive, Unit 13
 Mississauga, Ontario L5T 1R4
 Telephone: (800) 387-4938
 Facsimile: (905) 670-5850
 E-mail: sales@dormacanada.com

DORMA Mexico, S. de R.L. de C.V.
 Astrónomos 28
 Col. Escandón
 11800 México, D.F.
 Mexico
 Telephone: (52+55) 5272-6937
 Facsimile: (52+55) 5272-6948
 E-mail: dormaoper@prodigy.net.mx