



Surface Applied
Door Closers

DORMA TS93

The TS93 System in Contur Design represents the pinnacle of surface applied closers because of its unique cam and roller design.

Doors equipped with the TS93 will open much easier than doors with rack and pinion closers with track arms. The TS93 is a closer with regular arm operating efficiency and track arm aesthetics. When necessary, push side installation provides the benefits of track arm assemblies with the closer mounted to the door and the track mounted to the stop, creating a more tamper-resistant application.

Technical Details:

-  Available as TS9315 closers for interior and exterior barrier-free requirements (adjustable size 1–5).
- Available as TS9356 closers for greater closing force for exceptionally wide, tall, or heavy doors (size 5–6 +50% adjustment).
- Adjustable backcheck prevents uncontrolled opening of door.
- Adjustable delayed action extends the closing cycle to allow unobstructed passage through opening.
- Optional hold open, adjustable for degree of hold open and hold open force. Hold open is selectable on or off.
- SN3 sex nuts supplied standard for 1-3/4" thick door.
- Optional (CS) cushion limit stay for standard (T/PT) applications to assist slowing door in opening cycle (auxiliary stop required by others).

Certification:

The DORMA TS9315/TS9356 Series are listed by U.L. and C.U.L. under their continuing reinspection programs. The TS9315/TS9356 Series are certified to the requirements of ANSI A156.4 Grade 1. The TS93 is compliant with UL10C and UBC 7.2 (1997) for positive pressure. The TS9315 meets the requirements of ANSI A117.1 and A.D.A. for barrier-free accessibility. California State Fire Marshall Approved (CSFM).

Specification:

The TS93 System in Contur Design hydraulic surface applied closer with steel cam, roller, and adjustable spring, incorporating a track arm assembly. The TS93 will have two separate temperature compensating, noncritical adjustment valves to control sweep and latch closing speeds. Adjustable backcheck will take effect at approximately 65°. Adjustable hydraulic delayed action will be effective from approximately 120° to approximately 70°. The TS9315 will be available with field-adjustable spring power from size 1 to 5 for barrier-free requirements. The TS9356 will be adjustable from size 5 to 6 with 50% adjustment. Maximum opening range will be approximately 175° for pull side installations (T/ST) and 110° (PT) or 135° (SPT) for push side installations. Install the TS93 closer body on the door and the track arm assembly on the stop surface with the supplied bracket for push side (PT) applications. The TS93 will be non-handed.



Optional Specifications:

All TS93 closers to have hold open, adjustable for degree of hold open and hold open force. All TS93 closers to have optional heavy-duty spring stop track arms to assist stopping the door in the opening cycle. Degree of stop to be field selectable.

Warranty: 25 years.

Finishes:

Standard Sprayed Finishes:

Aluminum: 689.
Bronze: 691 (Dull), 690 (Statuary), or 695 (Dark Duranodic).
Gold: 696.
Black: 693.

Optional DORMA Custom Color or Designer Color Finishes:

Contact Customer Service.

Optional Plated Finishes¹:

Brass: 605 (Bright) or 606 (Satin).
Bronze: 612 (Satin) or 613 (Oxidized Satin Bronze Oil Rubbed).
Chrome: 625 (Bright).
Stainless: 630 (Satin).

1. Excludes all TS9356 devices except TS9356 PKT, which is available in 605 and 630 only.

Closer cover, arm, and track channel are plated. Cover end caps and track end caps are sprayed complementary or contrasting color.

REDUCED OPENING FORCE INSTALLATIONS CAUTION:

Manual door closers, including closers certified to meet BHMA/ANSI A156.4, when installed and adjusted to conform to ADA or other reduced opening force requirements, may not provide sufficient power to reliably close and latch a door.

Refer to catalog for ED800 Low Energy Operator to meet reduced opening force requirements without affecting closing power.



The quality management system at the Reamstown, PA facility is certified to ISO-9001:2000.*



*DORMA Door Controls Inc., dba: DORMA Architectural Hardware

Features	TS9315 T	TS9356 T	TS9315 PT	TS9356 PT
Adjustable spring size	1-5	5-6 +50%	1-5	5-6 +50%
Pull side application	•	•	-	-
Push side application	-	-	•	•
Controlled closing with two adjustment valves	175°-0° 7°-0°	175°-0° 7°-0°	110°-0° 7°-0°	110°-0° 7°-0°
Hydraulic backcheck	•	•	•	•
Hydraulic delayed action	•	•	•	•
Hold open	○ (H)	○ (H)	○ (H)	○ (H)
Dead stop	○ (ST)	○ (ST)	○ (SPT)	○ (SPT)
Dead stop with hold open	○ (STH)	-	-	-

• yes - no ○ option

How to Order TS93 Series

Arm Type

- 171°-180° Pocket Mount (TS9356 Only) — **TPKT180**
- 120°-170° Pocket Mount (TS9356 Only) — **TPKT170**
- 90°-119° Pocket Mount (TS9356 Only) — **TPKT119**
- 90° Pocket Mount, Pivots not included (TS9356 Only) — **TPKT90**
- *Spring Stop Track Hold Open (Push) — **SPTH**
- *Spring Stop Track Hold Open (Pull) — **STH**
- Push Side Track Hold — **PTH**
- Pull Side Track Hold — **TH**
- *Spring Stop Track (Push) — **SPT**
- *Spring Stop Track (Pull) — **ST**
- Push Side Track — **PT**
- Pull Side Track — **T**

Fastener Pack

- SN4** — Sex Nuts for 1-3/4" Door
- SN3** — Sex Nuts for 1-3/8" Door

Options

- CS** — Cushion Stop

Painted

- PNT** — Special Sprayed Finish (must specify)
- 696** — Gold
- 695** — Dark Duranodic Bronze
- 693** — Black
- 691** — Dull Bronze
- 690** — Statuary Bronze
- 689** — Aluminum
- 600** — Primed
- 605** — Bright Brass
- 606** — Satin Brass
- 612** — Satin Bronze
- 613** — Oxidized Satin Oil Rubbed Bronze
- 625** — Bright Chrome
- 630** — Satin Stainless Steel

Model

TS93 **15** **T** **SN3** **689**

Size 1-5 — **15** 90° Pocket Mount, includes 3 ea. 75523 — **TPKT90P**

Size 5-6 — **56** 90° Pocket Mount, includes 3 ea. 75520 — **TPKT90PF**

Spring Size **Packages** (may be used with TPKT90)

Plated¹

1. Excludes all TS9356 devices except TS9356 PKT, which is available in 605 and 630 only.

NOTE: All combinations of features and options are not available for all models.

*Available Summer 2009.

Track Installation × Jamb Mounted Slide Track Arm

TS9315 T
TS9315 THO

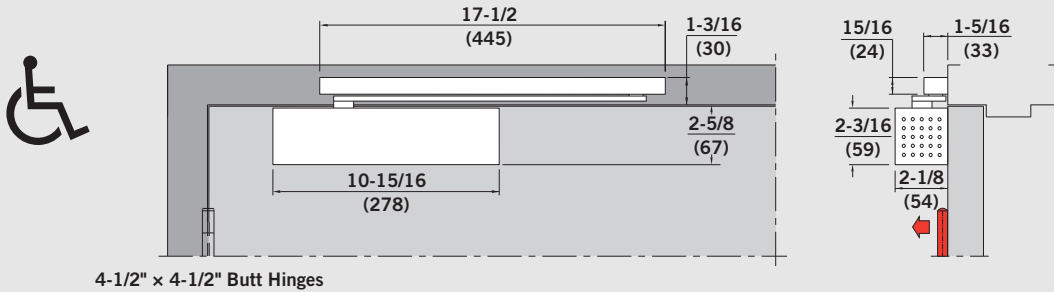

Size Selection Chart

CLOSER	INTERIOR/ EXTERIOR	DOOR WIDTH					MAXIMUM OPENING	APPROX. BACKCHECK	APPROX. DELAYED ACTION	MINIMUM HOLD OPEN	MAXIMUM HOLD OPEN	MINIMUM DOOR WIDTH
		2'-0" min.	2'-6" max.	3'-0" max.	3'-6" max.	4'-0" max.						
TS9315	INTERIOR	•	•	♿	♿	♿	175°	65°-175°	120°-70°	50°	140°	24"

- - Recommended application.
- ♿ - Opening force 5 lb or less on interior doors/8.5 lb or less on exterior doors where door without closer attached is 1 lb opening force or less.

NOTE: Although DORMA TS9315 Series closers have adjustable spring power to compensate for site conditions, it can not be guaranteed that adequate closing force will be obtained while complying with barrier-free opening force restrictions.

Track Installation × Stop Mounted Slide Track Arm

TS9315 PT
TS9315 PTHO

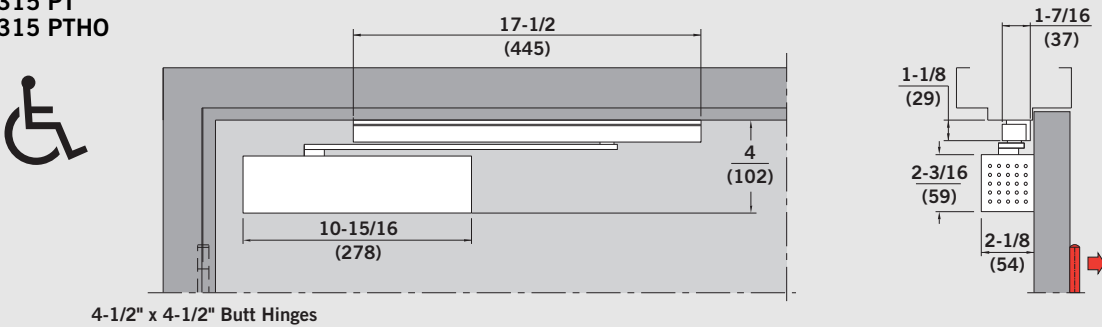

Size Selection Chart

CLOSER	INTERIOR/ EXTERIOR	DOOR WIDTH					MAXIMUM OPENING	APPROX. BACKCHECK	APPROX. DELAYED ACTION	MINIMUM HOLD OPEN	MAXIMUM HOLD OPEN	MINIMUM DOOR WIDTH
		2'-2" min.	2'-6" max.	3'-0" max.	3'-6" max.	4'-0" max.						
TS9315	INTERIOR	•	•	♿	♿	♿	110°	65°-110°	110°-70°	55°	105°	26"
	EXTERIOR	•	•	♿	♿	♿						

- - Recommended application.
- ♿ - Opening force 5 lb or less on interior doors/8.5 lb or less on exterior doors where door without closer attached is 1 lb opening force or less.

NOTE: Although DORMA TS9315 Series closers have adjustable spring power to compensate for site conditions, it can not be guaranteed that adequate closing force will be obtained while complying with barrier-free opening force restrictions.

Track Installation × Jamb Mounted Slide Track Arm

TS9315 ST

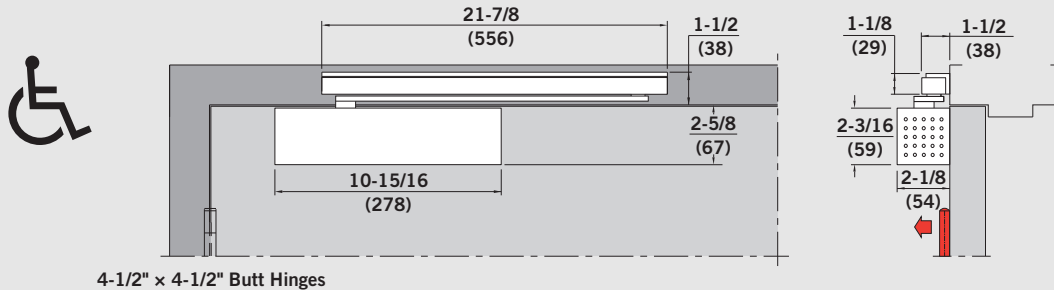

Size Selection Chart

CLOSER	INTERIOR/ EXTERIOR	DOOR WIDTH			MAXIMUM OPENING	APPROX. BACKCHECK	APPROX. DELAYED ACTION	MINIMUM DEAD STOP	MAXIMUM DEAD STOP	MINIMUM DOOR WIDTH
		3'-0" min.	3'-6" max.	4'-0" max.						
TS9315	INTERIOR	♿	♿	♿	175°	65°-175°	120°-70°	85°	110°	36"

♿ – Opening force 5 lb or less on interior doors/8.5 lb or less on exterior doors where door without closer attached is 1 lb opening force or less.

NOTE: Although DORMA TS9315 Series closers have adjustable spring power to compensate for site conditions, it can not be guaranteed that adequate closing force will be obtained while complying with barrier-free opening force restrictions.

Track Installation × Door Mounted Slide Track Arm

TS9315 STH

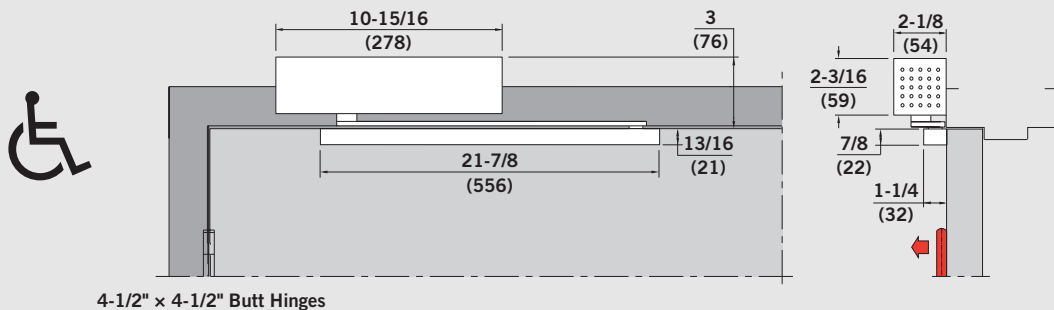

Size Selection Chart

CLOSER	INTERIOR/ EXTERIOR	DOOR WIDTH			MAXIMUM OPENING	APPROX. BACKCHECK	APPROX. DELAYED ACTION	MINIMUM HOLD OPEN	MAXIMUM HOLD OPEN	MINIMUM DOOR WIDTH
		3'-0" min.	3'-6" max.	4'-0" max.						
TS9315	INTERIOR	♿	♿	♿	175°	65°-175°	120°-70°	80°	105°	36"

♿ – Opening force 5 lb or less on interior doors/8.5 lb or less on exterior doors where door without closer attached is 1 lb opening force or less.

NOTE: Although DORMA TS9315 Series closers have adjustable spring power to compensate for site conditions, it can not be guaranteed that adequate closing force will be obtained while complying with barrier-free opening force restrictions.

Track Installation × Stop Mounted Slide Track Arm

TS9315 SPT
(Hold Open Not Available)

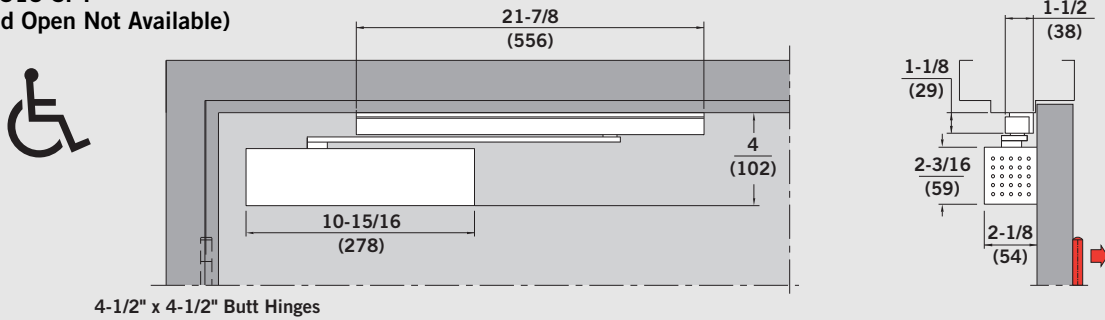

Size Selection Chart

CLOSER	INTERIOR/ EXTERIOR	DOOR WIDTH			MAXIMUM OPENING	APPROX. BACKCHECK	APPROX. DELAYED ACTION	MINIMUM DEAD STOP	MAXIMUM DEAD STOP	MINIMUM DOOR WIDTH
		3'-0" min.	3'-6" max.	4'-0" max.						
TS9315	INTERIOR	♿	♿	♿	135°	65°-135°	135°-70°	85°	110°	36"
	EXTERIOR	♿	♿	♿						

♿ – Opening force 5 lb or less on interior doors/8.5 lb or less on exterior doors where door without closer attached is 1 lb opening force or less.

NOTE: Although DORMA TS9315 Series closers have adjustable spring power to compensate for site conditions, it can not be guaranteed that adequate closing force will be obtained while complying with barrier-free opening force restrictions.

Track Installation × Jamb Mounted Slide Track Arm

TS9356 T
TS9356 THO

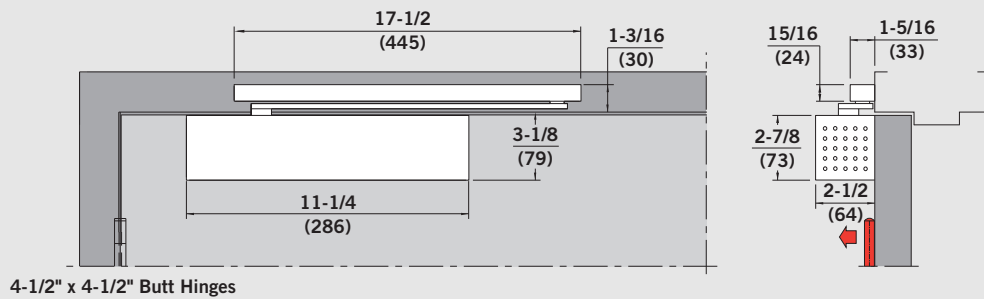

Size Selection Chart

CLOSER	INTERIOR/ EXTERIOR	DOOR WIDTH			MAXIMUM OPENING	APPROX. BACKCHECK	APPROX. DELAYED ACTION	MINIMUM HOLD OPEN	MAXIMUM HOLD OPEN	MINIMUM DOOR WIDTH
		4'-0" min.	4'-6" max.	5'-0" max.						
TS9356	INTERIOR	•	•	•	175°	65°-175°	120°-70°	50°	140°	24"
	EXTERIOR									

• – Recommended application.

Track Installation × Stop Mounted Slide Track Arm

TS9356 PT
TS9356 PTHO

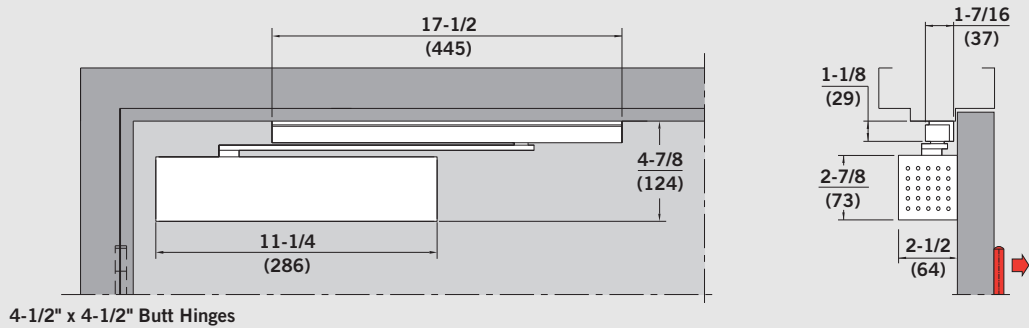

Size Selection Chart

CLOSER	INTERIOR/ EXTERIOR	DOOR WIDTH				MAXIMUM OPENING	APPROX. BACKCHECK	APPROX. DELAYED ACTION	MINIMUM HOLD OPEN	MAXIMUM HOLD OPEN	MINIMUM DOOR WIDTH
		3'-6" min.	4'-0" max.	4'-6" max.	5'-0" max.						
TS9356	INTERIOR	N/A	•	•	•	110°	65°-135°	110°-70°	55°	105°	26"
	EXTERIOR	•	•	•	N/A						

• – Recommended application.

N/A – Not applicable/application not recommended.

Track Installation × Jamb Mounted Slide Track Arm

TS9356 ST
(Hold Open Not Available)

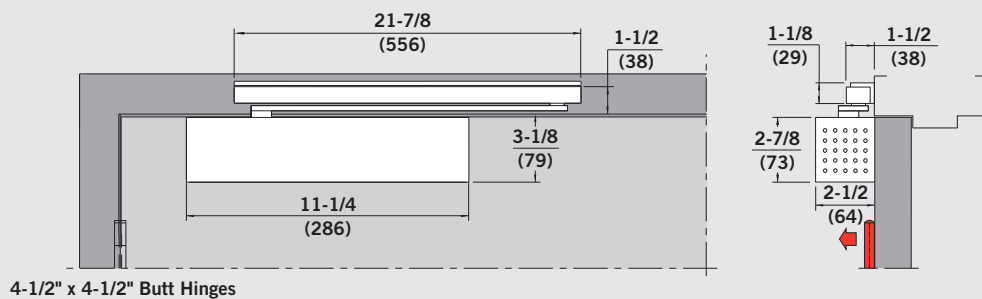

Size Selection Chart

CLOSER	INTERIOR/ EXTERIOR	DOOR WIDTH			MAXIMUM OPENING	APPROX. BACKCHECK	APPROX. DELAYED ACTION	MINIMUM DEAD STOP	MAXIMUM DEAD STOP	MINIMUM DOOR WIDTH
		4'-0" min.	4'-6" max.	5'-0" max.						
TS9356	INTERIOR	•	•	•	175°	65°-175°	120°-70°	85°	110°	48"

• – Recommended application.

Track Installation x Stop Mounted Slide Track Arm

TS9356 SPT
(Hold Open Not Available)

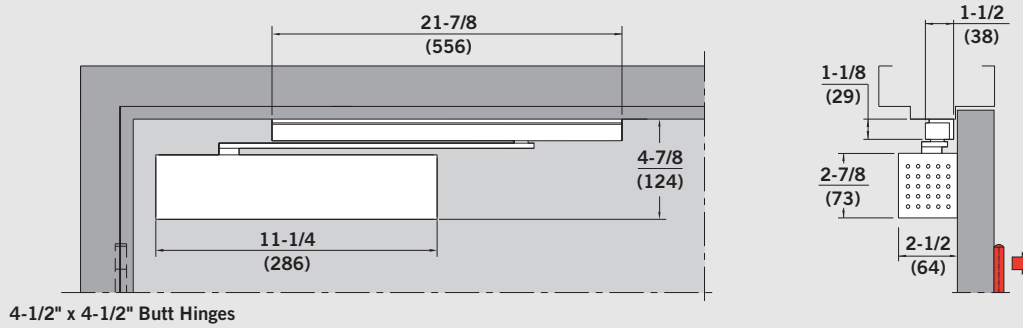

Size Selection Chart

CLOSER	INTERIOR/ EXTERIOR	DOOR WIDTH				MAXIMUM OPENING	APPROX. BACKCHECK	APPROX. DELAYED ACTION	MINIMUM DEAD STOP	MAXIMUM DEAD STOP	MINIMUM DOOR WIDTH
		3'-6" min.	4'-0" max.	4'-6" max.	5'-0" max.						
TS9356	INTERIOR	N/A	•	•	•	135°	65°-135°	135°-70°	85°	110°	42"
	EXTERIOR	•	•	•	N/A						

- Recommended application.

N/A - Not applicable/application not recommended.

The TS93 PKT pocket door applications accommodate opening angles ranging from 90°–180° while providing concealed hardware for doors that must be flush with the wall.

Technical Details (Pocket Doors):

- Available as TS9356 (size 5–6 +50% adjustment) closers for greater closing force for wider doors.
- Hardware is concealed when door is in pocket.
- Door surface is flush with corridor wall.
- No protruding edges.
- No dirt or debris buildup behind door.
- Open door fits completely into matched recessed wall pocket.
- Only 90° applications use pocket pivots.

Certification:

The PKT applications are listed by U.L. under their continuing reinspection programs. DORMA PKT U.L. listings apply when used on doors that meet the specified door width and maximum weight.

Specification:

DORMA pocket door closers for doors required to be flush with the corridor wall. The pocket door closers offer applications for 90°–180° opening angles. All pocket door closers combined with a DORMA EM Series wall magnet create a held open flush door until power is interrupted or the door is manually shut. The recommended method for hanging a 90° pocket door is via the use of DORMA pocket pivots 75520 or 75523 (fire rated). Doors beyond 90° up to 180° 4-1/2" × 4-1/2" ball bearing butt hinges are recommended.

Warranty: 25 years.

Finishes:

Standard Sprayed Finishes:

Aluminum: 689.

Bronze: 691 (Dull), 690 (Statuary), or 695 (Dark Duranodic).

Gold: 696.

Black: 693.

Optional DORMA Custom Color or Designer Color Finishes:

Contact Customer Service.

Optional Plated Finishes:

Brass: 605 (Bright).

Stainless: 630 (Satin).

Closer cover, arm and track channel are plated. Cover end caps and track end caps are sprayed complementary or contrasting color.



EM Series Wall Magnets

See individual product brochure for specific information.

Features (Pocket Doors)	TS9356 PKT 90	TS9356 PKT 90/119 OP	TS9356 PKT 120/170	TS9356 PKT 180
Adjustable spring size	5–6 +50%	5–6 +50%	5–6 +50%	5–6 +50%
Pull side application	•	•	•	•
Controlled closing with two adjustment valves	90°–0° 7°–0°	119°–0° 7°–0°	170°–0° 7°–0°	180°–0° 7°–0°
Hydraulic backcheck	•	•	•	•
Hydraulic delayed action	•	•	•	•

- yes

90° Pocket Installation

TS9356 PKT 90

Size Selection Chart

CLOSER	DOOR WIDTH RANGE	MAXIMUM WEIGHT
TS9356 PKT 90	3'-1" to 4'-6"	250 lb

The recommended method for hanging a 90° pocket door is via the use of pocket pivots. Pocket pivots create optimum unobstructed space while creating a flush appearance with the door in line with the frame.

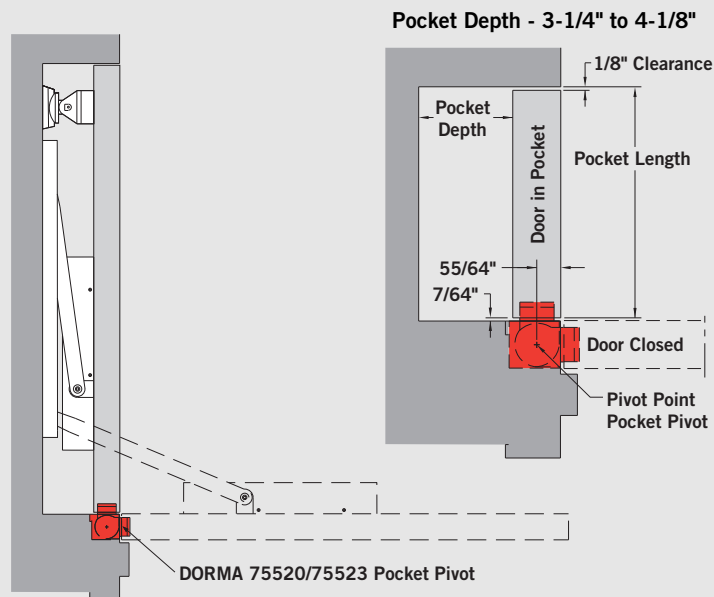

NOTE: The DORMA EM-504 wall magnet has a 3-1/2" (89 mm) projection, the EM-505 × ER-1.5 has a 4" (102 mm) projection, the EM-508 has a 4-1/16" (103 mm) projection, and the EM-509 × ER-1.5 extension has a 3-5/16" (84 mm) projection. For pocket depths not equalling these projections, a shim by others is required for the door mounted catch plate.

90° Through 119° Pocket Installation

TS9356 PKT 90/119 OP

Size Selection Chart

CLOSER	DOOR WIDTH RANGE	MAXIMUM WEIGHT
TS9356 PKT 90/119 OP	2'-8" to 4'	150 lb

The recommended method for hanging the door is via the use of hinges. Hinges create optimum unobstructed space when the door is in the pocket. Alternatives, such as Offset Pivots, Swing Clear Hinges, and Continuous Hinges may be used. When using alternate methods, determine where the pivot point of the hinge or the pivot locates the door at the angle of opening when designing the pocket depth.

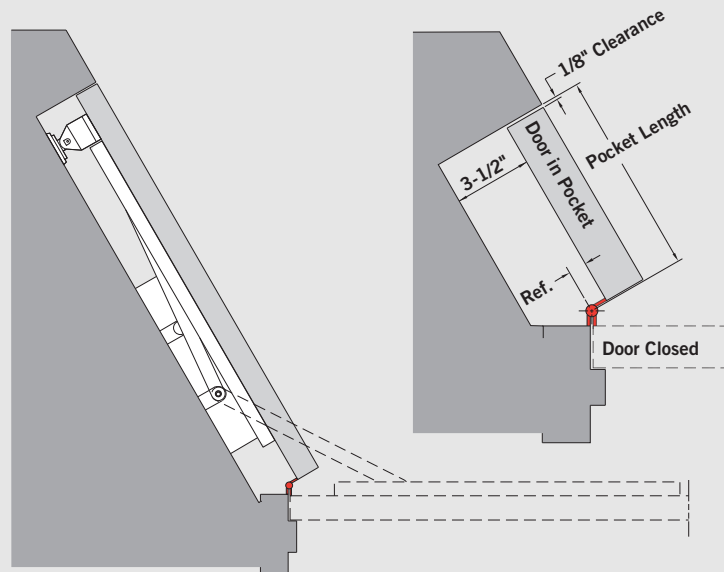

NOTE: The DORMA EM-504 wall magnet (included in the TS9356 PKT 90/119 OP package) has a 3-1/2" (89 mm) projection, and the pocket must be designed accordingly.

120° Through 170° Pocket Installation

TS9356 PKT 120/170

Size Selection Chart

CLOSER	DOOR WIDTH RANGE	MAXIMUM WEIGHT
TS9356 PKT 120/170	2'-8" to 4'	150 lb

The recommended method for hanging the door is via the use of hinges. Hinges create optimum unobstructed space when the door is in the pocket. Alternatives, such as Offset Pivots, Swing Clear Hinges, and Continuous Hinges may be used. When using alternate methods, determine where the pivot point of the hinge or the pivot locates the door at the angle of opening when designing the pocket depth.

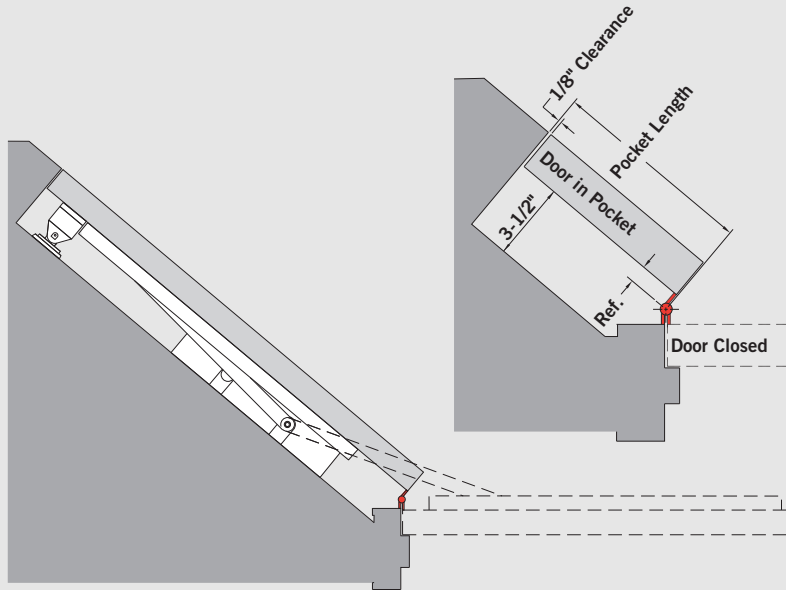

NOTE: The DORMA EM-504 wall magnet (included in the TS9356 PKT 120/170 package) has a 3-1/2" (89 mm) projection, and the pocket must be designed accordingly.

180° Pocket Installation

TS9356 PKT 180

Size Selection Chart

CLOSER	DOOR WIDTH RANGE	MAXIMUM WEIGHT
TS9356 PKT 180	2'-8" to 4'	150 lb

The recommended method for hanging the door is via the use of hinges. Hinges create optimum unobstructed space when the door is in the pocket. Alternatives, such as Offset Pivots, Swing Clear Hinges, and Continuous Hinges may be used. When using alternate methods, determine where the pivot point of the hinge or the pivot locates the door at the angle of opening when designing the pocket depth.

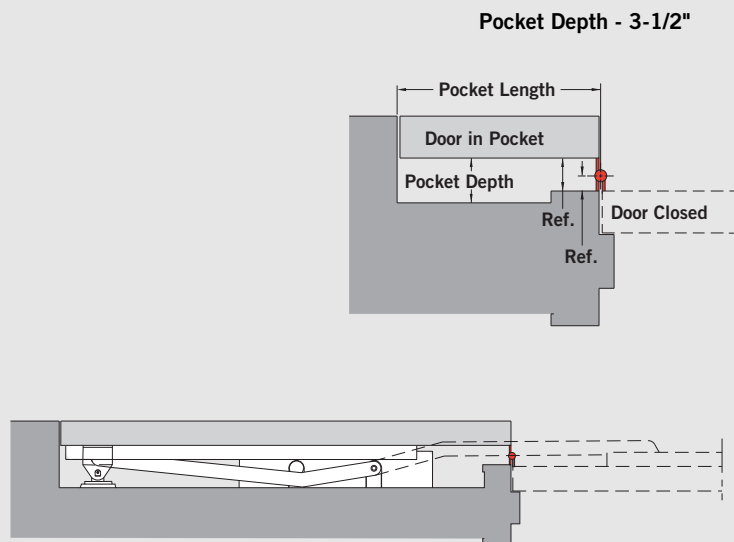

NOTE: The DORMA EM-504 wall magnet (included in the TS9356 PKT 180 package) has a 3-1/2" (89 mm) projection, and the pocket must be designed accordingly.



**DORMA Group
North America**
www.dorma-usa.com

DORMA Architectural Hardware
DORMA Drive, Drawer AC
Reamstown, PA 17567-0411
Telephone: (800) 523-8483
Facsimile: (800) 274-9724
E-mail: archw@dorma-usa.com

DORMA Canada
1680 Courtney Park Drive, Unit 13
Mississauga, Ontario L5T 1R4
Telephone: (800) 387-4938
Facsimile: (905) 670-5850
E-mail: sales@dormacanada.com

DORMA Mexico, S. de R.L. de C.V.
Astrónomos 28, Col. Escandón
México, D.F. 11800
Del. Miguel Hidalgo
Telephone: (52+55) 5272-6937
Facsimile: (52+55) 5272-6948
E-mail: operacion@dorma.com.mx