

AEGIS II[®]



INDUSTRIAL ORNAMENTAL STEEL FENCE

Aegis II is the obvious front-runner in *strength and durability for fence and gates*. With a dual wall ForeRunner rail and *multi-layer coating*, this fence system is unmatched in overall product performance. In addition, the superior component design of Aegis II makes it *easy to customize for any project application*.



PRIMARY APPLICATIONS

- *Stadiums & Event Centers*
- *Schools & Universities*
- *Airports*
- *Water Treatment & Storage*
- *Public Housing Authorities*
- *State Facilities*
- *Municipal Facilities*
- *Parks & Recreation*
- *Hospitals*



FENCE PRODUCTS

AMERISTARFENCE.COM | 888-333-3422

ASSA ABLOY, the global leader in door opening solutions

AMERISTAR[®]

ASSA ABLOY

AEGIS II[®]

INDUSTRIAL ORNAMENTAL STEEL FENCE

1"sq x 14ga PICKETS | 1.75"sq x 1.75"sq x 14ga ForeRunner™ RAILS | 2.5"sq x 12ga & 3"sq x 12ga POSTS

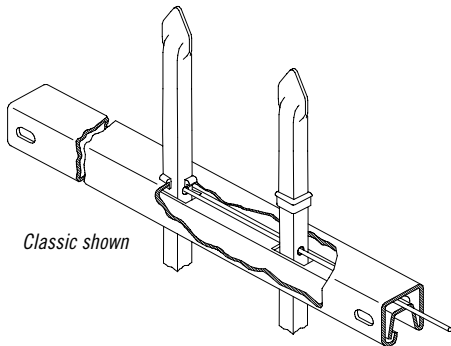

STYLE OPTIONS

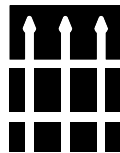

CLASSIC™



MAJESTIC™

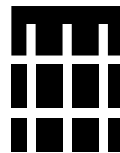

GENESIS™

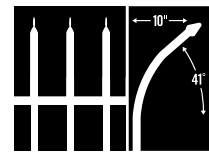

INVINCIBLE™



FABRICATION & DESIGN

Ameristar crafted the ForeRunner rail to increase strength through architecture. The innovative design of the ForeRunner rail contains an internally secured rod that allows for variable pitch connection, high angle biasability and eliminates the need for visually unappealing external fasteners. Galvanized inside and out; to protect against internal corrosion; puts the ForeRunner rail in the upper echelon of fencing options.



PERMACOAT™ PROTECTIVE FINISH

Ameristar's production facilities use a state-of-the-art polyester powder coating system that provides a durable and scratch resistant finish. Aegis II is protected with Ameristar's PermaCoat multi-layer coating process. The combination of these layers delivers a system that increases weathering resistance and product durability. The Ameristar coating system results in finished surfaces with unmatched performance.



10 YEAR LIMITED WARRANTY

The family of Aegis steel fencing products are manufactured from the highest quality materials by skilled craftsmen to meet the highest standards of workmanship in the industry. This is why Ameristar proudly offers a limited 10 year warranty.



DOMESTIC MANUFACTURING

Ameristar is committed to providing products that are manufactured in the USA. We have made significant investments in technology, process improvement, and employee training in an effort to secure American jobs and combat inferior import products.



FENCE PRODUCTS

TO PLACE YOUR ORDER CALL 888-333-3422

VISIT AMERISTARFENCE.COM

AEGIS II® | 2 & 3-RAIL OPTIONS | 4" AIR-SPACE

STANDARD BOTTOM OPTION AVAILABLE

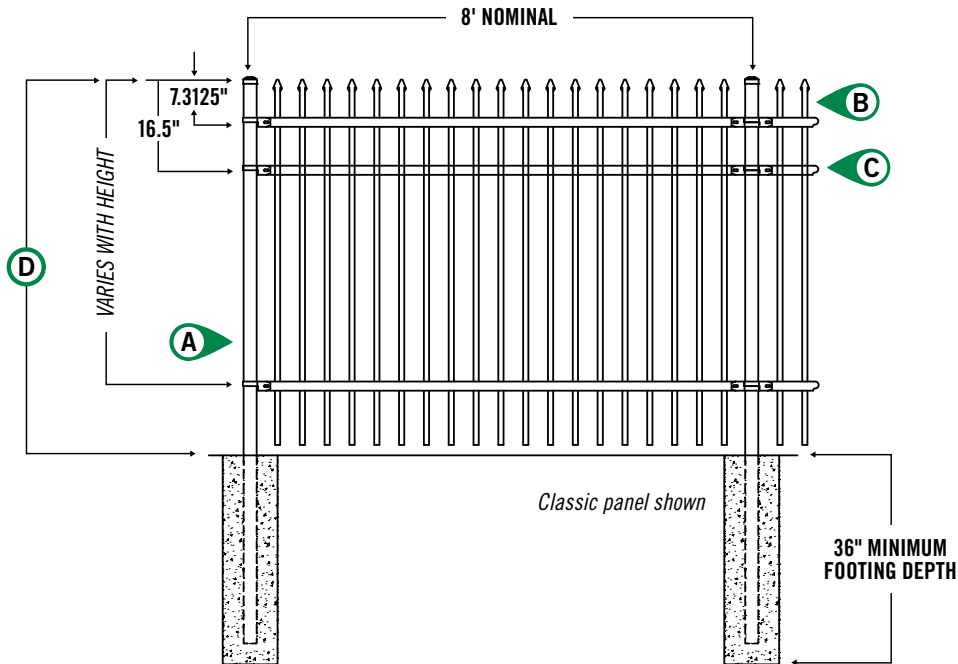

- Ⓐ 2.5"sq x 12ga / 3"sq x 12ga POSTS
- Ⓑ 1"sq x 14ga PICKETS
- Ⓒ 1.75" x 1.75" x 14ga ForeRunner RAILS
- Ⓓ 3', 3½', 4', 5', 6', 7', 8', 9' & 10' PANEL HEIGHTS

PANELS REQUIRE ASSEMBLY

Refer to construction specification & tables within this section for recommended post space by bracket type

Effective: 01/06/15

AEGIS II® | 2-RAIL PANELS | 8' PANEL LENGTH

STANDARD BOTTOM | 8' PANEL LENGTH (92.625"/91.25"† actual width) | 19 / 20† PICKETS PER PANEL | ASSEMBLY REQUIRED

PANEL	ITEM NUMBER	WEIGHT	STOCKING
3'	2☒☒20348	86 lbs	☉
3.5'	2☒☒20408	95 lbs	☉
4'	2☒☒20468	103 lbs	☉
5'	2☒☒20588	120 lbs	☉
6'	2☒☒20708	138 lbs	☉
7'	2☒☒20828	154 / 160†	☉
8'	2☒☒20948	171 / 179†	☉
9'	2☒☒21068	190 / 197†	☉
10'	2☒☒21188	207 / 216†	☉

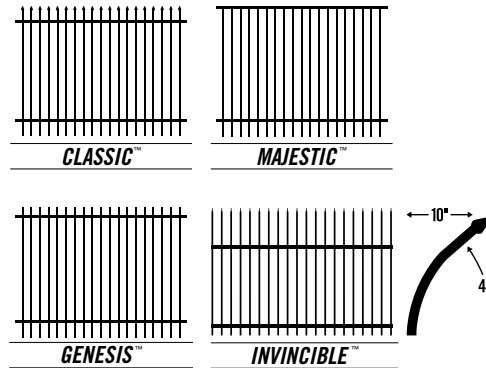

☒ = FENCE STYLES AVAILABLE | **C** = Classic **M** = Majestic **G** = Genesis
I = Invincible†

☒ = COLOR OPTIONS AVAILABLE | **B** = Black **N** = Bronze **W** = White
S = Sand

☉ = NON-STOCKED PRODUCT
 For details, see Ameristar's Sales Policy in the catalog guide.

AEGIS II® | 2-RAIL PANELS | 6' PANEL LENGTH

STANDARD BOTTOM | 6' PANEL LENGTH (67.75"/71.375"† actual width) | 14 / 15† PICKETS PER PANEL | ASSEMBLY REQUIRED

PANEL	ITEM NUMBER	WEIGHT	STOCKING
3'	2☒☒20346	64 lbs	☉
3.5'	2☒☒20406	71 lbs	☉
4'	2☒☒20466	77 lbs	☉
5'	2☒☒20586	90 lbs	☉
6'	2☒☒20706	102 lbs	☉
7'	2☒☒20826	114 / 127†	☉
8'	2☒☒20946	127 / 142†	☉
9'	2☒☒21066	139 / 166†	☉
10'	2☒☒21186	152 / 171†	☉

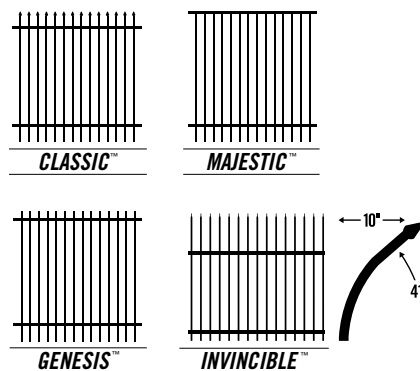

☒ = FENCE STYLES AVAILABLE | **C** = Classic **M** = Majestic **G** = Genesis
I = Invincible†

☒ = COLOR OPTIONS AVAILABLE | **B** = Black **N** = Bronze **W** = White
S = Sand

☉ = NON-STOCKED PRODUCT
 For details, see Ameristar's Sales Policy in the catalog guide.

Effective: 01/06/15

AEGIS II® | 3-RAIL PANELS | 8' PANEL LENGTH

STANDARD BOTTOM | 8' PANEL LENGTH (92.625"/91.25"† actual width) | 19 / 20† PICKETS PER PANEL | ASSEMBLY REQUIRED

PANEL	ITEM NUMBER	WEIGHT	STOCKING
3'	2☒☒30348	103	☉
3.5'	2☒☒30408	112	☉
4'	2☒☒30468	120	☉
5'	2☒☒30588	137	☉
6'	2☒☒30708	154	☉
7'	2☒☒30828	171 / 177†	☉
8'	2☒☒30948	188 / 196†	☉
9'	2☒☒31068	206 / 214†	☉
10'	2☒☒31188	224 / 233†	☉

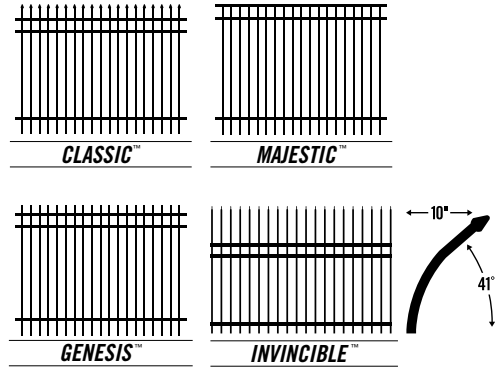

- ☒ = FENCE STYLES AVAILABLE | **C** = Classic **M** = Majestic **G** = Genesis
I = Invincible†
- ☒ = COLOR OPTIONS AVAILABLE | **B** = Black **N** = Bronze **W** = White
S = Sand
- ☉ = NON-STOCKED PRODUCT
For details, see Ameristar's Sales Policy in the catalog guide.

AEGIS II® | 3-RAIL PANELS | 6' PANEL LENGTH

STANDARD BOTTOM | 6' PANEL LENGTH (67.75"/71.375"† actual width) | 14 / 15† PICKETS PER PANEL | ASSEMBLY REQUIRED

PANEL	ITEM NUMBER	WEIGHT	STOCKING
3'	2☒☒30346	76	☉
3.5'	2☒☒30406	83	☉
4'	2☒☒30466	89	☉
5'	2☒☒30586	102	☉
6'	2☒☒30706	114	☉
7'	2☒☒30826	126 / 140†	☉
8'	2☒☒30946	139 / 155†	☉
9'	2☒☒31066	151 / 169†	☉
10'	2☒☒31186	164 / 184†	☉

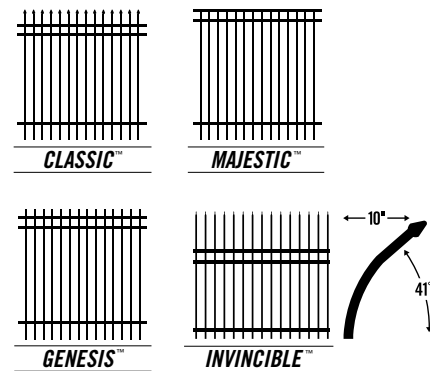

- ☒ = FENCE STYLES AVAILABLE | **C** = Classic **M** = Majestic **G** = Genesis
I = Invincible†
- ☒ = COLOR OPTIONS AVAILABLE | **B** = Black **N** = Bronze **W** = White
S = Sand
- ☉ = NON-STOCKED PRODUCT
For details, see Ameristar's Sales Policy in the catalog guide.

Effective: 01/06/15

AEGIS II® | 3-RAIL PANELS WITH RINGS | 8' PANEL LENGTH

STANDARD BOTTOM | 8' PANEL LENGTH (92.625" actual width) | 19 PICKETS PER PANEL | ASSEMBLY REQUIRED

PANEL	ITEM NUMBER	WEIGHT	STOCKING
3'	2☒☒30348R	109 lbs	☉
3.5'	2☒☒30408R	118 lbs	☉
4'	2☒☒30468R	126 lbs	☉
5'	2☒☒30588R	143 lbs	☉
6'	2☒☒30708R	160 lbs	☉
7'	2☒☒30828R	177 lbs	☉
8'	2☒☒30948R	194 lbs	☉
9'	2☒☒31068R	212 lbs	☉
10'	2☒☒31188R	230 lbs	☉

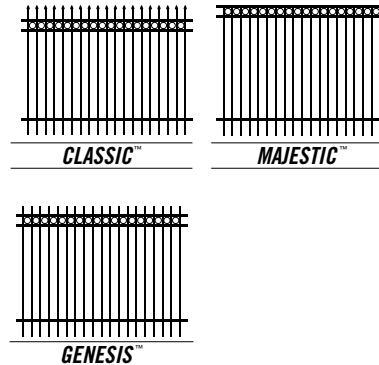

☒ = FENCE STYLES AVAILABLE | **C** = Classic **M** = Majestic **G** = Genesis
 ☒ = COLOR OPTIONS AVAILABLE | **B** = Black **N** = Bronze **W** = White **S** = Sand
 ☉ = NON-STOCKED PRODUCT
 For details, see Ameristar's Sales Policy in the catalog guide.

AEGIS II® | 3-RAIL PANELS WITH RINGS | 6' PANEL LENGTH

STANDARD BOTTOM | 6' PANEL LENGTH (67.75" actual width) | 15 PICKETS PER PANEL | ASSEMBLY REQUIRED

PANEL	ITEM NUMBER	WEIGHT	STOCKING
3'	2☒☒30346R	80 lbs	☉
3.5'	2☒☒30406R	87 lbs	☉
4'	2☒☒30466R	93 lbs	☉
5'	2☒☒30586R	106 lbs	☉
6'	2☒☒30706R	118 lbs	☉
7'	2☒☒30826R	130 lbs	☉
8'	2☒☒30946R	143 lbs	☉
9'	2☒☒31066R	155 lbs	☉
10'	2☒☒31186R	168 lbs	☉

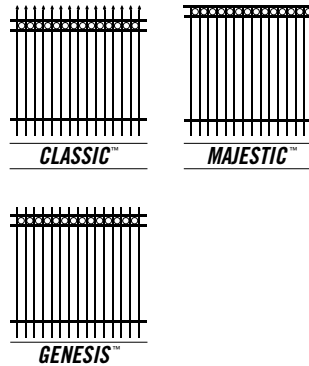





☒ = FENCE STYLES AVAILABLE | **C** = Classic **M** = Majestic **G** = Genesis
 ☒ = COLOR OPTIONS AVAILABLE | **B** = Black **N** = Bronze **W** = White **S** = Sand
 ☉ = NON-STOCKED PRODUCT
 For details, see Ameristar's Sales Policy in the catalog guide.

Effective: 01/06/15

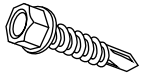
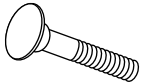
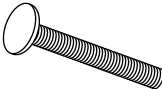

AEGIS II® | FASTENERS

AVAILABLE IN BOX QUANTITIES ONLY

	DESCRIPTION	ITEM NUMBER / BLACK	ITEM NUMBER / OTHERS	WEIGHT	BAG QTY
	#14 x .75" Self-Drilling Screws	1-0004-1P-50	1-0004-2P-50	.6 lbs	50
	<i>Steel hex head self-drilling screws for industrial brackets</i>				
	.25" x 2" Carriage Bolts	HB516P	HN516P	.03 lbs	1
	<i>Steel carriage bolt for industrial brackets</i>				
	Carriage Bolts	.3125" x 3.5"	H⊗302P	.082 lbs	1
		.3125" x 4"	2-0006-1P	.09 lbs	1
	.3125" Flange Nuts	HB300P	HN300P	.013 lbs	1
	.25" Tee Nuts	B7157RP-20	N7157RP-20	.3 lbs	20
	Fastener Socket	8865PFG	n/a	.06 lbs	1
	<i>Tamper-proof fasteners require socket for installation</i>				
	One-Way Screw Remover	88246P	1	.10 lbs	n/a

AEGIS II® | FINIALS & ADORNMENTS

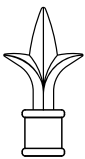
FINIALS & PICKET PLUGS FOR GENESIS PANELS ONLY | ADORNMENTS FOR 3-RAIL PANELS ONLY

		
QUAD FLARE	TRIAD	ROYALTY
1" / .5 lbs A⊗ 512	1" / .5 lbs A⊗ 514	1" / .26 lbs A⊗ 526

RINGS
1" / .3 lbs A⊗ 511

1" PRESS FIT PICKET FINIALS

- » 19 finials required per 8' panel
- » 14 finials required per 6' panel

⊗ = COLOR OPTIONS AVAILABLE | **B** = Black **N** = Bronze
W = White **S** = Sand

*NOTE: Picket plugs are available in bag quantities only / 19 plugs per bag.
 Item number: 8450P-20 = **B** / 8453P = **W***

AEGIS II PANEL ADORNMENTS

- » Must be used with Aegis II ring rails
- » Must be ordered in box quantity / 18 adornments per box

⊗ = COLOR OPTIONS AVAILABLE | **B** = Black **N** = Bronze
W = White **S** = Sand

Effective: 01/06/15

AEGIS II® | BRACKETS

AVAILABLE IN BAG QUANTITIES ONLY

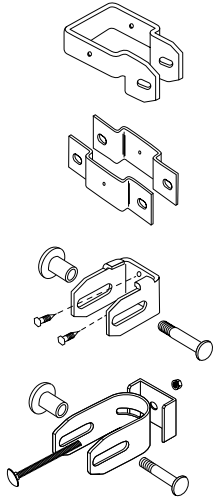

DESCRIPTION	SIZE	ITEM NUMBER	BAG QTY	BOX QTY	WEIGHT
Universal Boulevard Bracket*	2.5"	B⊗302S	2	80	.46 lbs
	3"	B⊗303S	2	60	.53 lbs
<i>Bags packaged with: #14 x .75" self-drilling screws .25" x 2" carriage bolts .25" tee nuts</i>					
Invincible Line Bracket	2.5"	B⊗319S	2	24	1.2 lbs
	3"	B⊗320S	2	24	1.2 lbs
<i>Bags packaged with: #14 x .75" self-drilling screws .25" x 2" carriage .25" tee nuts</i>					
Flat Mount Bracket		B⊗301S	2	100	.42 lbs
<i>Bags packaged with: #14 x .75" self-drilling screws .25" x 2" carriage bolts .25" tee nuts</i>					
Swivel Bracket		B⊗304S	2	80	1.0 lbs
<i>Bags packaged with: .3125" x 4" carriage bolt .3125" flange nuts .25" x 2" carriage bolts .25" tee nuts</i>					

⊗ = COLOR OPTIONS AVAILABLE | **B** = Black **N** = Bronze **W** = White **S** = Sand

* Not for use with Invincible style panels

AEGIS II® | CUSTOM FINISHES

WARRANTY ON CUT COMPONENTS VOID WITHOUT PROPER TOUCH-UP APPLICATION*

*For details & the guidelines for the proper 3-step process, see Ameristar's Sales Policy in the catalog guide

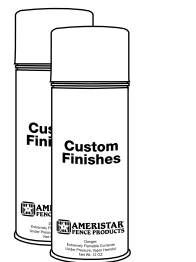
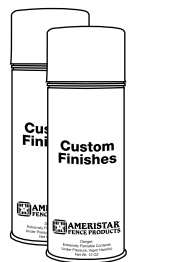
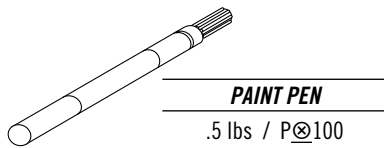

⊗ = COLOR OPTIONS AVAILABLE | **B** = Black **N** = Bronze **W** = White **S** = Sand

Effective: 01/06/15

AEGIS II® | COMPONENTS

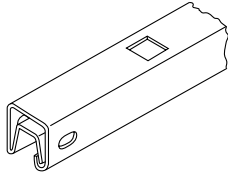

DESCRIPTION	PANEL HEIGHT	LENGTH	ITEM NUMBER	BOX QTY	WEIGHT
ForeRunner Rail / Through Punched	8'	92.625"	C⊗ R28N	4	17 lbs
	6'	67.75"	C⊗ R26N	6	13 lbs

Used for Classic, Genesis & Majestic (not Majestic top rail) styles. Includes grommets & retaining rods.

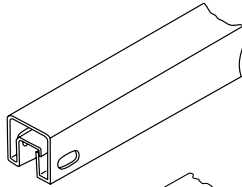

ForeRunner Rail / Bottom Punched	8'	92.625"	M⊗ R28N	4	18 lbs
	6'	67.75"	M⊗ R26N	6	13 lbs

Used for Majestic top rail. Includes retaining rods.

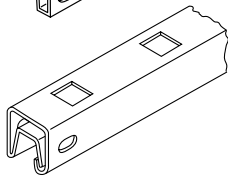

ForeRunner Rail / Through Punched FOR INVINCIBLE ONLY	8'	91.25"	I⊗ R28N	4	17 lbs
	6'	71.375"	I⊗ R26N	6	13 lbs

Used for Invincible style. Includes grommets & retaining rods.

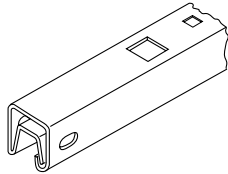

ForeRunner Rail / Through Punched FOR RINGS	8'	92.625"	R⊗ R28N	4	17 lbs
	6'	67.75"	R⊗ R26N	6	13 lbs

Used for rail located below rings. Includes grommets & retaining rods.

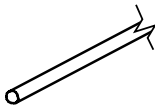

Retaining Rods	67"	H531P	1	.25 lbs
	92.625"	H530P	1	.32 lbs

Galvanized over .125" diameter steel.

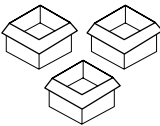

Grommet Sets	.75" sq.	X⊗ 150P	15	3 oz.
	.75" sq.	X⊗ 190P-20	19	4 oz.

Available in bag quantities only.

⊗ = COLOR OPTIONS AVAILABLE | **B** = Black | **N** = Bronze | **W** = White | **S** = Sand

Effective: 01/06/15

AEGIS II® | STEEL SQUARE POSTS

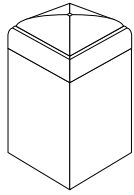

STEEL POSTS

	POST LENGTH	ITEM NUMBER	WEIGHT
2.5"sq. x 12ga.	5'	PⓂ25060	16 lbs
	6'	PⓂ25072	19 lbs
	7'	PⓂ25084	22 lbs
	8'	PⓂ25096	26 lbs
	9'	PⓂ25108	28 lbs
	10'	PⓂ25120	31 lbs
	11'	PⓂ25132	35 lbs
	12'	PⓂ25144	36 lbs
	13'	PⓂ25156	40 lbs
	14'	PⓂ25168	43 lbs
3"sq. x 12ga.	15'	PⓂ25180	46 lbs
	5'	PⓂ30060	20 lbs
	6'	PⓂ30072	24 lbs
	7'	PⓂ30084	30 lbs
	8'	PⓂ30096	34 lbs
	9'	PⓂ30108	39 lbs
	10'	PⓂ30120	43 lbs
	11'	PⓂ30132	47 lbs
	12'	PⓂ30144	51 lbs
	13'	PⓂ30156	56 lbs
4"sq. x 11ga.	14'	PⓂ30168	60 lbs
	15'	PⓂ30180	64 lbs
	16'	PⓂ30192	69 lbs
	6'	PⓂ40072	39 lbs
	7'	PⓂ40084	47 lbs
	8'	PⓂ40096	54 lbs
	9'	PⓂ40108	61 lbs
	10'	PⓂ40120	67 lbs
	11'	PⓂ40132	74 lbs
	12'	PⓂ40144	81 lbs
13'	PⓂ40156	87 lbs	
14'	PⓂ40168	94 lbs	
15'	PⓂ40180	101 lbs	
16'	PⓂ40192	108 lbs	
18'	PⓂ40216	114 lbs	
20'	PⓂ40240	126 lbs	
24'	PⓂ40288	162 lbs	

ADDITIONAL LENGTHS CONTINUED ON NEXT PAGE

Effective: 01/06/15

AEGIS II® | STEEL SQUARE POSTS

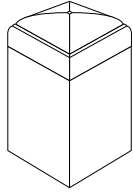

STEEL POSTS

6"sq. x .1875" wall

8"sq. x .25" wall

POST LENGTH	ITEM NUMBER	WEIGHT
7'	P⊗60084	102 lbs
8'	P⊗60096	116 lbs
9'	P⊗60108	131 lbs
10'	P⊗60120	145 lbs
11'	P⊗60132	160 lbs
12'	P⊗60144	174 lbs
13'	P⊗60156	189 lbs
14'	P⊗60168	203 lbs
15'	P⊗60180	218 lbs
16'	P⊗60192	232 lbs
9'	P⊗80108	233 lbs
10'	P⊗80120	259 lbs
11'	P⊗80132	285 lbs
12'	P⊗80144	311 lbs
13'	P⊗80156	336 lbs
14'	P⊗80168	370 lbs
15'	P⊗80180	390 lbs
16'	P⊗80192	415 lbs
20'	P⊗80240	517 lbs
24'	P⊗80288	620 lbs

⊗ = COLOR OPTIONS AVAILABLE | **B** = Black **N** = Bronze **W** = White **S** = Sand

NOTE: When installed in a location subject to freezing, where posts are grouted into core-drilled holes, a .25" diameter hole should be drilled in the post approximately .5" above elevation to allow for drainage of built-up ground water. The drilled hole must be wiped clean and dry before applying Ameristar zinc primer and color finish.

Effective: 01/06/15

TO PLACE YOUR ORDER CALL 888-333-3422 | VISIT AMERISTARFENCE.COM

AMERISTAR
ASSA ABLOY

⊗ = COLOR OPTIONS AVAILABLE | **B** = Black **N** = Bronze **W** = White
S = Sand

AEGIS II® | STEEL PLATED SQUARE POSTS

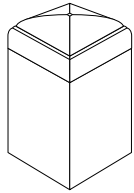

STEEL POSTS

	POST LENGTH	PLATE SIZE	ITEM NUMBER	WEIGHT
2.5"sq. x 12ga.	4'	5" sq. x .25" / .5625" holes (8833G)	P⊗ 25048P	16 lbs
	5'	5" sq. x .25" / .5625" holes (8833G)	P⊗ 25060P	19 lbs
	6'	5" sq. x .25" / .5625" holes (8833G)	P⊗ 25072P	22 lbs
	7'	5" sq. x .25" / .5625" holes (8833G)	P⊗ 25084P	26 lbs
	8'	5" sq. x .25" / .5625" holes (8833G)	P⊗ 25096P	28 lbs
	9'	5" sq. x .25" / .5625" holes (8833G)	P⊗ 25108P	31 lbs
3"sq. x 12ga.	10'	5" sq. x .25" / .5625" holes (8833G)	P⊗ 25120P	34 lbs
	4'	6" sq. x .25" / .5625" holes (5003G)	P⊗ 30048P	20 lbs
	5'	6" sq. x .25" / .5625" holes (5003G)	P⊗ 30060P	24 lbs
	6'	6" sq. x .25" / .5625" holes (5003G)	P⊗ 30072P	30 lbs
	7'	6" sq. x .25" / .5625" holes (5003G)	P⊗ 30084P	34 lbs
	8'	6" sq. x .25" / .5625" holes (5003G)	P⊗ 30096P	39 lbs
4"sq. x 11ga.	9'	6" sq. x .25" / .5625" holes (5003G)	P⊗ 30108P	43 lbs
	10'	8" sq. x .25" / .5625" holes (5003G)	P⊗ 30120P	47 lbs
	4'	8" sq. x .375" / .5625" holes (8876G)	P⊗ 40048P	33 lbs
	5'	8" sq. x .375" / .5625" holes (8876G)	P⊗ 40060P	39 lbs
	6'	8" sq. x .375" / .5625" holes (8876G)	P⊗ 40072P	47 lbs
	7'	8" sq. x .375" / .5625" holes (8876G)	P⊗ 40084P	54 lbs
	8'	8" sq. x .375" / .5625" holes (8876G)	P⊗ 40096P	61 lbs
	9'	8" sq. x .375" / .5625" holes (8876G)	P⊗ 40108P	67 lbs
	10'	8" sq. x .375" / .5625" holes (8876G)	P⊗ 40120P	74 lbs

⊗ = COLOR OPTIONS AVAILABLE | **B** = Black **N** = Bronze **W** = White **S** = Sand

NOTE: Posts used with Majestic may require an additional 1" longer than the panel or gate height, depending on the grade elevation.

Effective: 01/06/15

AEGIS II® | POST CAPS

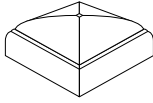

STANDARD FLAT CAP
Steel

CAP SIZE	ITEM NUMBER	WEIGHT
2.5"sq.	A⊗ 507	0.3 lbs
3"sq.	A⊗ 508	0.3 lbs
4"sq.	A⊗ 509	0.4 lbs
6"sq.	A⊗ 515	0.8 lbs
8"sq.	A⊗ 801	2.0 lbs



BALL CAP
Aluminum

CAP SIZE	ITEM NUMBER	WEIGHT
2.5"sq.	A⊗ 513	0.7 lbs
3"sq.	A⊗ 516	0.8 lbs
4"sq.	A⊗ 517	2.0 lbs
6"sq.	A⊗ 521	8.0 lbs

⊗ = **COLOR OPTIONS AVAILABLE** | **B** = Black | **N** = Bronze | **W** = White
S = Sand

Effective: 01/06/15

AEGIS II® | CONSTRUCTION SPECIFICATION 32 31 19**HEAVY INDUSTRIAL STEEL ORNAMENTAL FENCE SYSTEM – INTERNALLY SECURED****PART 1 - GENERAL****1.01 WORK INCLUDED**

The contractor shall provide all labor, materials and appurtenances necessary for installation of the industrial ornamental steel fence system defined herein at (specify project site).

1.02 RELATED WORK

Section ____ - Earthwork

Section ____ - Concrete

1.03 SYSTEM DESCRIPTION

The manufacturer shall supply a total industrial ornamental steel fence system of the Ameristar® Aegis II® (specify *Classic™, Majestic™, Genesis™ or Invincible™*) design. They system shall include all components (i.e., pickets, rails, posts, gates and hardware) required.

1.04 QUALITY ASSURANCE

The contractor shall provide laborers and supervisors who are thoroughly familiar with the type of construction involved and materials and techniques specified.

1.05 REFERENCES

- **ASTM A653/A653M** – Standard Specification for Steel Sheet, Zinc-Coated (*Galvanized*) or Zinc-Iron Alloy Coated (*Galvannealed*) by the Hot-Dip Process
- **ASTM B117** – Practice for Operating Salt-Spray (*Fog*) Apparatus
- **ASTM D523** – Test Method for Specular Gloss
- **ASTM D714** – Test Method for Evaluating Degree of Blistering in Paint
- **ASTM D822** – Practice for Conducting Tests on Paint and Related Coatings and Materials using Filtered Open – Flame Carbon – Arc Light and Water Exposure Apparatus
- **ASTM D1654** – Test Method for Evaluation of Painted or Coated Specimens Subjected to Corrosive Environments
- **ASTM D2244** – Test Method for Calculation of Color Differences from Instrumentally Measured Color Coordinates
- **ASTM D2794** – Test Method for Resistance of Organic Coatings to the Effects of Rapid Deformation (Impact)
- **ASTM D3359** – Test Method for Measuring Adhesion by Tape Test
- **ASTM F2408** – Ornamental Fences Employing Galvanized Steel Tubular Pickets

1.06 SUBMITTAL

The manufacturer's submittal package shall be provided prior to installation.

1.07 PRODUCT HANDLING AND STORAGE

Upon receipt at the job site, all materials shall be checked to ensure that no damages occurred during shipping or handling. Materials shall be stored in such a manner to ensure proper ventilation and drainage, and to protect against damage, weather, vandalism and theft.

1.08 PRODUCT WARRANTY

- A. All structural fence components (i.e. rails, pickets, and posts) shall be warranted within specified limitations, by the manufacturer for a period of 10 years from date of original purchase. Warranty shall cover any defects in material finish, including cracking, peeling, chipping, blistering or corroding.
- B. Reimbursement for labor necessary to restore or replace components that have been found to be defective under the terms of manufacturer's warranty shall be guaranteed for five (5) years from date of original purchase.

PART 2 - MATERIALS**2.01 MANUFACTURER**

The fence system shall conform to Ameristar Aegis II, (specify *Classic, Majestic, Genesis, or Invincible*) design, (specify *2-Rail, 3-Rail, or 3-Rail with Rings*) style manufactured by Ameristar Fence Products, Inc. in Tulsa, Oklahoma.

2.02 MATERIAL

- A. Steel material for fence framework (i.e. tubular pickets, rails and posts), shall be galvanized prior to forming in accordance with the requirements of **ASTM A653/A653M**, with minimum yield strength of 45,000 psi (310 MPa). The steel shall be hot-dip galvanized to meet the requirements of **ASTM A653/A653M** with a minimum zinc coating weight of 0.90 oz/ft² (276 g/m²), Coating Designation G-90.
- B. Material for pickets shall be 1" square x 14 Ga. tubing. The cross-sectional shape of the rails shall conform to the manufacturer's ForeRunner™ double wall design with outside cross-section dimensions of 1.75" square and a minimum thickness of 14 Ga. Picket holes in the ForeRunner rail shall be spaced 4.715" o.c., except for Invincible style 6' long, which shall be, spaced 4.98" o.c. Picket retaining rods shall be 0.125" diameter galvanized steel. High quality PVC grommets shall be supplied to seal all picket-to-rail intersections. Fence posts and gate posts shall meet the minimum size requirements of **Table 1**.

2.03 FABRICATION

- A. Pickets, rails and posts shall be precut to specified lengths.

Effective: 01/06/15

AEGIS II® | CONSTRUCTION SPECIFICATION 32 31 19

HEAVY INDUSTRIAL STEEL ORNAMENTAL FENCE SYSTEM – INTERNALLY SECURED

- ForeRunner rails shall be prepunched to accept pickets. Pickets shall be predrilled to accept retaining rods.
- B.** Grommets shall be inserted into the prepunched holes in the rails and pickets shall be inserted through the grommets so that predrilled picket holes align with the internal upper raceway of the ForeRunner rails (*Note: This can best be accomplished by making an alignment jig*). Retaining rods shall be inserted into each ForeRunner rail so that they pass through the predrilled holes in each picket.
- C.** The manufactured galvanized framework shall be subjected to the PermaCoat® thermal stratification coating process (*high-temperature, in-line, multi-stage, multi-layer*) including, as a minimum, a six-stage pretreatment/wash (*with zinc phosphate*), an electrostatic spray application of an epoxy base, and a separate electrostatic spray application of a polyester finish. The base coat shall be a thermosetting epoxy powder coating (*gray in color*) with a minimum thickness of 2 mils (0.0508mm). The topcoat shall be a “no-mar” TGIC polyester powder coat finish with a minimum thickness of 2 mils (0.0508mm). The color shall be (specify Black, Bronze, White, or Desert Sand). The stratification-coated framework shall be capable of meeting the performance requirements for each quality characteristic shown in **Table 2**.
- D.** Completed sections (i.e., panels) shall be capable of supporting a 600 lb. load applied at midspan without permanent deformation. Panels shall be biasable to a 25% change in grade.
- E.** Swing gates shall be fabricated using 1.75" x 14ga ForeRunner double channel rail, 2" sq. x 11ga. gate ends, and 1" sq. x 14ga. pickets. Gates that exceed 6' in width will have a 1.75" sq. x 14ga. intermediate upright. All rail and upright intersections shall be joined by welding. All picket and rail intersections shall also be joined by welding.

PART 3 - EXECUTION

3.01 PREPARATION

All new installation shall be laid out by the contractor in accordance with the construction plans.

3.02 FENCE INSTALLATION

Fence post shall be spaced according to **Table 3**, plus or minus ½". For installations that must be raked to follow sloping grades, the post spacing dimension must be measured along the grade. Fence panels shall be attached to posts with brackets supplied by the manufacturer. Posts

shall be set in concrete footers having a minimum depth of 36" (*Note: In some cases, local restrictions of freezing weather conditions may require a greater depth*). The "Earthwork" and "Concrete" sections of this specification shall govern material requirements for the concrete footer. Posts setting by other methods such as plated posts or grouted core-drilled footers are permissible only if shown by engineering analysis to be sufficient in strength for the intended application.

3.03 FENCE INSTALLATION MAINTENANCE

When cutting/drilling rails or posts adhere to the following steps to seal the exposed steel surfaces; 1) Remove all metal shavings from cut area. 2) Apply zinc-rich primer to thoroughly cover cut edge and/or drilled hole; let dry. 3) Apply 2 coats of custom finish paint matching fence color. Failure to seal exposed surfaces per steps 1-3 above will negate warranty. Ameristar spray cans or paint pens shall be used to prime and finish exposed surfaces; it is recommended that paint pens be used to prevent overspray. Use of non-Ameristar parts or components will negate the manufacturer's warranty.

3.04 GATE INSTALLATION

Gate posts shall be spaced according to the manufacturer's gate drawings, dependent on standard out-to-out gate leaf dimensions and gate hardware selected. Type and quantity of gate hinges shall be based on the application; weight, height, and number of gate cycles. The manufacturer's gate drawings shall identify the necessary gate hardware required for the application. Gate hardware shall be provided by the manufacture of the gate and shall be installed per manufacturer's recommendations.

3.05 CLEANING

The contractor shall clean the jobsite of excess materials; post-hole excavations shall be scattered uniformly away from posts.

SEE REFERENCED TABLES ON THE FOLLOWING PAGE

Effective: 01/06/15

AEGIS II® | CONSTRUCTION SPECIFICATION 32 31 19

HEAVY INDUSTRIAL STEEL ORNAMENTAL FENCE SYSTEM – INTERNALLY SECURED

TABLE 1

MINIMUM SIZES FOR AEGIS II POSTS				
FENCE POSTS	PANEL HEIGHTS			
2½" x 12 ga.	up to and including 6' height			
3" x 12 ga.	over 6' and including 10' height			
4" x 11 ga.	over 10' height			
GATE LEAF	GATE HEIGHT			
	up to & including 6'	Over 6' to 8'	Over 8' to 10'	Over 12'
up to 4'	3" x 12 gauge	3" x 12 gauge	4" x 11 gauge	4" x 11 gauge
4'1" to 6'	3" x 12 gauge	3" x 12 gauge	4" x 11 gauge	4" x 11 gauge
6'1" to 8'	4" x 11 gauge	6" x ¾"	6" x ¾"	6" x ¾"
8'1" to 10'	4" x 11 gauge	6" x ¾"	6" x ¾"	6" x ¾"
10'1" to 12'	6" x ¾"	6" x ¾"	6" x ¾"	8" x ¼"
12'1" to 16'	6" x ¾"	6" x ¾"	8" x ¼"	8" x ¼"

TABLE 2

COATING PERFORMANCE REQUIREMENTS		
QUALITY CHARACTERISTICS	ASTM TEST METHOD	PERFORMANCE REQUIREMENTS
ADHESION	D3359 – METHOD B	Adhesion (<i>retention of coating</i>) over 90% of test area (<i>tape and knife kit test</i>).
CORROSION RESISTANCE	B117, D714, D1654	Corrosion resistance over 3,500 hours (<i>scribed per D1654; failure mode is accumulation of 1/8" coating loss from scribe or medium #8 blisters</i>)
IMPACT RESISTANCE	D2794	Impact resistance over 60" lb. (<i>forward impact using 0.625" ball</i>).
WEATHERING RESISTANCE	D822 D2244, D523 (60° method)	Weathering resistance over 1,000 hours (<i>failure mode is 60% loss of gloss or color variance of more than 3 delta-E color units</i>).

TABLE 3

AEGIS II POST SPACING BY BRACKET TYPE										
SPAN	Invincible: 8' / 6' nominal (91½" / 67¾" rails)		Classic, Genesis & Majestic: 8' / 6' nominal (92½" / 71¾" rails)							
	2½"	3"	2½"	3"	2½"	3"	2½"	3"	2½"	3"
BRACKET TYPE	Industrial Flat Mount (BB301)*		Industrial Universal (BB302)		Industrial Universal (BB303)		Industrial Flat Mount (BB301)		Industrial Swivel (BB304)*	
POST SETTINGS ± ½" O.C.	94½" / 75"	95" / 75.5"	96" / 71.5"	96½" / 72"	96" / 71.5"	96½" / 72"	96" / 71.5"	96½" / 72"	*97½" / *73"	*98" / *73.5"

*When using BB304 swivel brackets on either or both ends of a panel installation, care must be taken to ensure the spacing between post and adjoining pickets meets applicable codes. This will require trimming one or both ends of the panel. When using the BB301 flat mount bracket for Invincible style, rail may need to be drilled to accommodate rail to bracket attachment.

TABLE 4

AEGIS II WIND LOADING				
FENCE HEIGHT	RAIL LENGTH	POST SIZE	WIND LOAD CAPACITY FACTOR (PSF)	TYPICAL WIND LOAD CAPACITY (MPH)
4'	6'	2½" x 12 ga.	102.3 (PSF)	236 (MPH)
		3" x 12 ga.	122.8 (PSF)	259 (MPH)
	8'	2½" x 12 ga.	77.0 (PSF)	205 (MPH)
		3" x 12 ga.	92.2 (PSF)	224 (MPH)
5'	6'	2½" x 12 ga.	65.5 (PSF)	189 (MPH)
		3" x 12 ga.	78.6 (PSF)	203 (MPH)
	8'	2½" x 12 ga.	49.3 (PSF)	164 (MPH)
		3" x 12 ga.	59.0 (PSF)	179 (MPH)
6'	6'	2½" x 12 ga.	45.5 (PSF)	157 (MPH)
		3" x 12 ga.	54.6 (PSF)	172 (MPH)
	8'	2½" x 12 ga.	34.2 (PSF)	136 (MPH)
		3" x 12 ga.	41.0 (PSF)	149 (MPH)
7'	6'	2½" x 12 ga.	33.4 (PSF)	135 (MPH)
		3" x 12 ga.	40.0 (PSF)	147 (MPH)
	8'	2½" x 12 ga.	25.0 (PSF)	116 (MPH)
		3" x 12 ga.	30.0 (PSF)	128 (MPH)
8'	6'	2½" x 12 ga.	25.6 (PSF)	118 (MPH)
		3" x 12 ga.	30.7 (PSF)	129 (MPH)
	8'	2½" x 12 ga.	19.2 (PSF)	102 (MPH)
		3" x 12 ga.	23.0 (PSF)	112 (MPH)
9'	6'	4" x 11 ga.	30.6 (PSF)	129 (MPH)
		4" x 11 ga.	32.0 (PSF)	132 (MPH)
10'	6'	4" x 11 ga.	28.7 (PSF)	125 (MPH)

MPH values shown in Table 4 are provided for information only. They are calculated using ANSI/AISC 7-05, "American Society of Civil Engineers Minimum Design Loads for Buildings and Other Structures" Exposure Category C (open terrain with scattered obstructions having lengths generally less than 30 feet), based on post setting in 36" deep concrete footer in soil assumed to be of mid-range strength and compaction. Since specified project conditions such as jurisdictional building codes, elevation of installation, post base/footer design, soil strength, etc., may change from project to project, a structural engineering evaluation, unique to applicable requirements and conditions, should be performed. Consult your Ameristar Service Representative for an estimate on Engineering Analysis and PE Certification.

AEGIS II® | LIMITED WARRANTY

INTERNALLY SECURED STEEL ORNAMENTAL FENCE PRODUCTS

Aegis II® Industrial Steel Ornamental Fence System by Ameristar® is manufactured from the highest quality materials by skilled craftsmen to meet the highest standards of workmanship in the industry. Galvanized steel framework shall be subject to a six stage pretreatment/wash (with zinc phosphate) followed by an electrostatic spray application of PermaCoat® Color System, a two coat powder system. The base coat is a thermosetting epoxy powder coating (gray in color). The top coat is a “no-mar” TGIC polyester powder coat finish, which provides the protection necessary to withstand adverse environmental conditions.

The powder coated surface on all framework (i.e., pickets, rails and posts) by Ameristar is guaranteed under normal and proper usage, against cracking, peeling, chipping, blistering or corroding for a period of ten (10) years from the original purchase date. Normal and proper usage does not include physical damage, abrasion or exposure to salty environments to the protective coating.

Aegis II Industrial Steel Ornamental Fence System framework is also guaranteed for the same period of time against defects in workmanship or materials.

Should any ornamental fence framework manufactured by Ameristar Fence Products fail in accordance with any of the above conditions, Ameristar Fence Products warrants to the original purchaser their redemption through replacement, renewal or issuance of a pro-rated credit. The decision as to which method of redemption is allowed is solely at the discretion of Ameristar. If pro-rated allowance is the chosen alternative, the amount will be based on the total number of years under warranty from date of purchase to date of claim, based on the original cost of framing materials found to be defective. Notice of failure under the conditions of this warranty shall be sent to Ameristar Fence Products or its authorized representative, in writing, together with proof of purchase and shall specify the nature of the defect and when it was first observed. When cutting Aegis II components immediately seal the exposed surfaces by 1) Removing all metal shavings from cut area 2) Apply zinc-rich primer to thoroughly cover cut edge and drilled hole; let dry 3) Apply 2 coats of custom finish paint matching fence color. Failure to seal exposed surfaces per steps 1-3 above will negate warranty. If the contractor uses non Ameristar parts/components this will negate the warranty. Should the fence be improperly installed, Ameristar Fence Products shall not be responsible for guaranteed performance or appearance of the material. Neither does this guarantee apply when failure or damage is due to improper use or application, abuse or misuse, salty environments, vandalism or acts of God. Ameristar Fence Products reserves the right to inspect the material to determine validity of the claim.

Upon validation of the claim by Ameristar Fence Products or its authorized representative, redemption by replacement, renewal or issuance of a pro-rated credit shall be made by Ameristar Fence Products. Reimbursement for labor necessary to restore and/or replace components that have been found defective under the terms of this warranty is guaranteed to the original purchaser for a period of five (5) years from the original purchase date. Ameristar reserves the right to select the qualified company or individual to perform the labor to repair or replace the components that are deemed to be defective under the terms of this warranty.

The above constitutes the complete warranty by the manufacturer. No other agreement, written or implied, is valid. Ameristar Fence Products does not authorize any other person or agent to make any other express warranties. Ameristar Fence Products neither assumes nor authorizes any other person or agent to assume any other liability in connection with Aegis II Industrial Steel Ornamental Fence System. Some jurisdictions do not allow limitations on how long an implied warranty lasts, nor do they allow an exclusion or limitation of incidental or consequential damages; therefore, the limitations and exclusions noted herein may not apply.

Effective: 01/06/15

AEGIS II® | SINGLE SWING w/STRAIGHT PICKETS GATE SPECIFICATIONS

2"sq x 12ga STEEL GATE ENDS | 1.75" ForeRunner™ RAILS | 14ga wall STEEL PICKETS | 3.5' - 16' NOMINAL OPENINGS

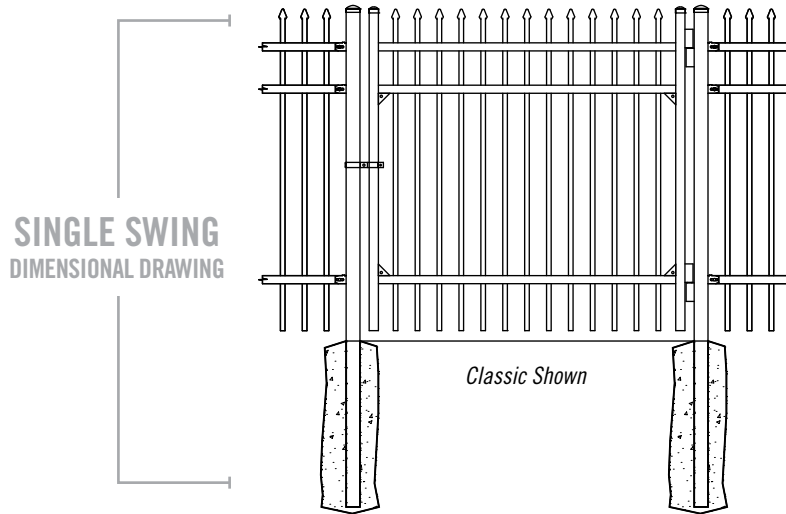

IGBSX25 / IGBSX3
FORK LATCH / BOX
HINGE KITS

SGBSXA
AMERISTAR LOCK/BOX
HINGE KIT

SINGLE SWING
HARDWARE KITS & POST
INTERSPACES

OPENING	LEAF WIDTH*	HC	LC	P _s	HC	LC	P _s
3.5'	40.25"	2"	2"	44.25"	2"	.625"	47.875"
4'	49.5"	2"	2"	53.5"	2"	.625"	52.125"
5'	59"	2"	2"	63"	2"	.625"	61.625"
6'	68.5"	2"	2"	72.5"	2"	.625"	71.125"
7'	78"	2"	2"	82"	2"	.625"	80.625"
8'	96.75"	2"	2"	100.75"	2"	.625"	99.375"
9'	106.25"	2"	2"	110.25"	2"	.625"	108.875"
10'	115.5"	2"	2"	119.5"	2"	.625"	118.125"
11'	134.5"	2"	2"	138.5"	2"	.625"	137.125"
12'	143.75"	2"	2"	147.75"	2"	.625"	146.375"
13'	153.25"	2"	2"	157.25"	2"	.625"	155.875"
14'	162.75"	2"	2"	166.75"	2"	.625"	165.375"
15'	181.5"	2"	2"	185.5"	2"	.625"	184.125"
16'	191"	2"	2"	195"	2"	.625"	193.625"

W = width* | HC = hinge clearance | LC = latch clearance | P_s = gate post spacing**
* From outside to outside | ** From inside to inside

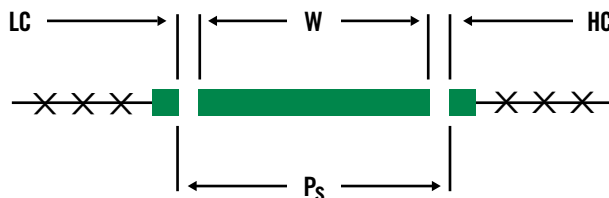

Effective: 01/06/15

AEGIS II® | DOUBLE SWING w/STRAIGHT PICKETS GATE SPECIFICATIONS

2"sq x 12ga STEEL GATE ENDS | 1.75" ForeRunner™ RAILS | 14ga wall STEEL PICKETS | 7' - 32' NOMINAL OPENINGS

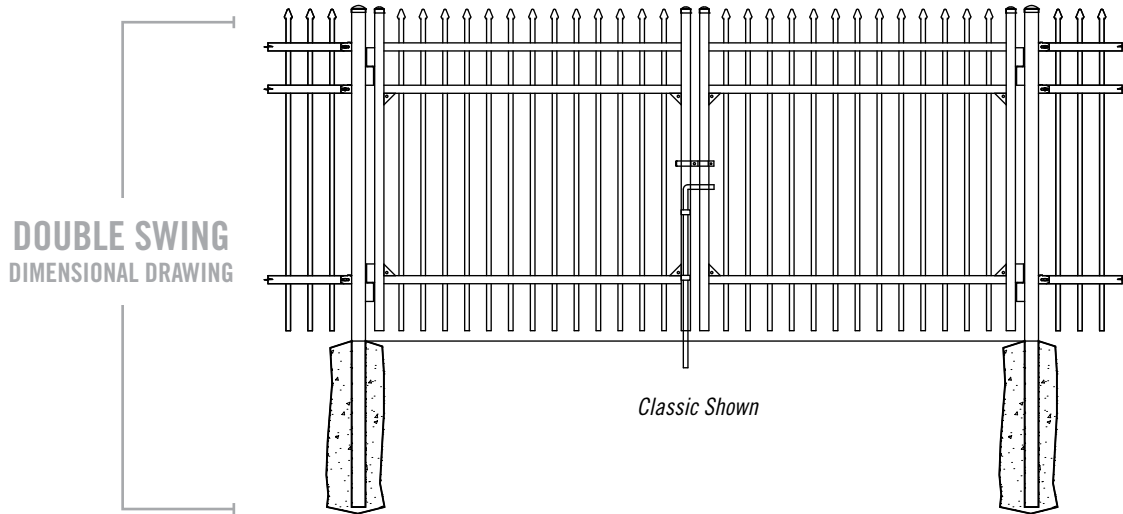

IGBDX
FORK HINGE / BOX
KITS

OPENING	LEAF WIDTH*	HC	LC	P _d
7'	40.25"	2"	2"	86.5"
8'	49.5"	2"	2"	105"
10'	59"	2"	2"	124"
12'	68.5"	2"	2"	143"
14'	78"	2"	2"	162"
16'	96.75"	2"	2"	199.5"
18'	106.25"	2"	2"	218.5"
20'	115.5"	2"	2"	237"
22'	134.5"	2"	2"	275"
24'	143.75"	2"	2"	293.5"
26'	153.25"	2"	2"	312.5"
28'	162.75"	2"	2"	333.5"
30'	181.5"	2"	2"	369"
32'	191"	2"	2"	388"

DOUBLE SWING
HARDWARE KITS & POST
INTERSPACES

W = width (x2)* | HC = hinge clearance (x2)
 LC = latch clearance | P_d = gate post spacing**
 * From outside to outside | ** From inside to inside

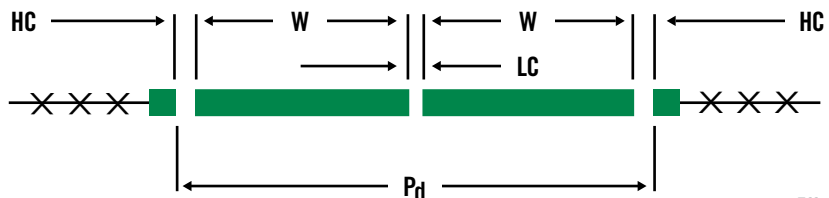

Effective: 01/06/15

AEGIS II® | SINGLE SWING w/CURVED PICKETS GATE SPECIFICATIONS

2"sq x 12ga STEEL GATE ENDS | 1.75" ForeRunner™ RAILS | 14ga wall STEEL PICKETS | 3.5' - 16' NOMINAL OPENINGS

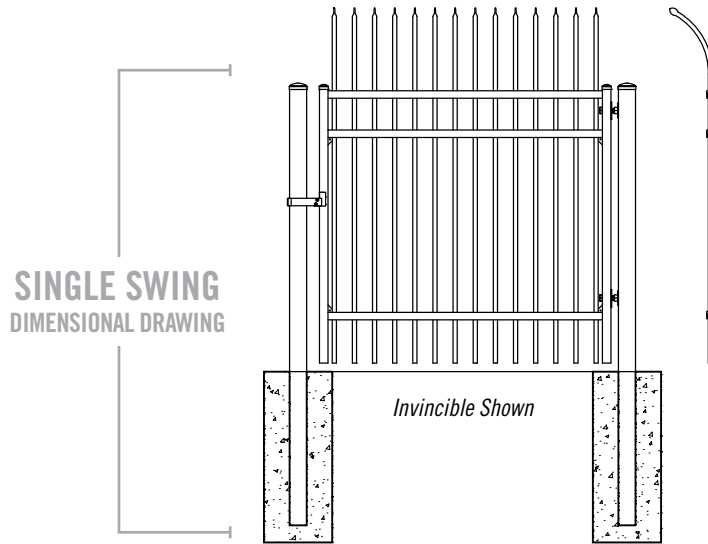

IGBSX25 / IGBSX3
FORK LATCH / BOX
HINGE KITS

IGBS-25
IGBS-3 / IGBS-4
INDUSTRIAL COMMERCIAL
HINGE KITS

SINGLE SWING
HARDWARE KITS & POST
INTERSPACES

OPENING	LEAF WIDTH*	HC	LC	P _S	HC	LC	P _S
3.5'	40"	2"	2"	44"	1.5"	3"	44.5"
4'	44.75"	2"	2"	48.75"	1.5"	3"	49.25"
5'	58.875"	2"	2"	62.875"	1.5"	3"	63.375"
6'	68.25"	2"	2"	72.25"	1.5"	3"	72.75"
7'	82.375"	2"	2"	86.375"	1.5"	3"	86.875"
8'	91.875"	2"	2"	95.875"	1.5"	3"	96.375"
9'	106"	2"	2"	110"	1.5"	3"	110.5"
10'	115.375"	2"	2"	119.375"	1.5"	3"	119.875"
11'	129.5"	2"	2"	133.5"	1.5"	3"	134"
12'	139"	2"	2"	143"	1.5"	3"	143.5"
13'	153.125"	2"	2"	157.125"	1.5"	3"	157.625"
14'	167.25"	2"	2"	171.25"	1.5"	3"	171.75"
15'	176.75"	2"	2"	180.75"	1.5"	3"	181.25"
16'	190.875"	2"	2"	194.875"	1.5"	3"	195.375"

W = width* | HC = hinge clearance | LC = latch clearance | P_S = gate post spacing**
* From outside to outside | ** From inside to inside

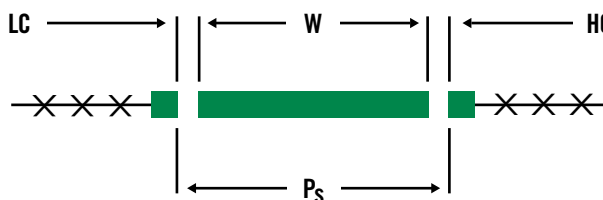

Effective: 01/06/15

AEGIS II® | DOUBLE SWING w/CURVED PICKETS GATE SPECIFICATIONS

2"sq x 12ga STEEL GATE ENDS | 1.75" ForeRunner™ RAILS | 14ga wall STEEL PICKETS | 7' - 32' NOMINAL OPENINGS

DOUBLE SWING
DIMENSIONAL DRAWING

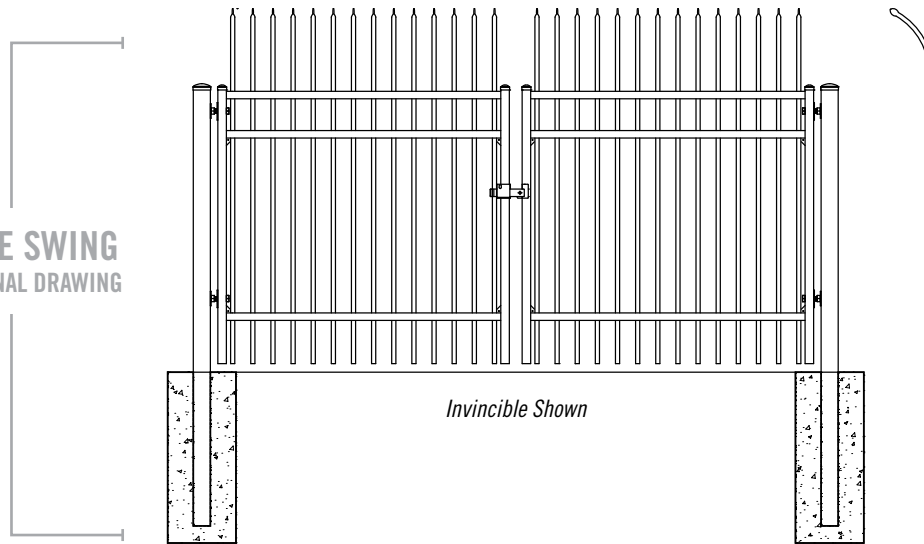

IGBDX
BOX HINGE KITS

OPENING	LEAF WIDTH*	HC	LC	P _d
7'	40"	2"	2"	86"
8'	44.75"	2"	2"	95.5"
10'	58.875"	2"	2"	123.75"
12'	68.25"	2"	2"	142.5"
14'	82.375"	2"	2"	170.75"
16'	91.875"	2"	2"	189.75"
18'	106"	2"	2"	218"
20'	115.375"	2"	2"	236.75"
22'	129.5"	2"	2"	265"
24'	139"	2"	2"	284"
26'	153.125"	2"	2"	312.25"
28'	167.25"	2"	2"	340.5"
30'	176.75"	2"	2"	359.5"
32'	190.875"	2"	2"	387.75"

DOUBLE SWING
HARDWARE KITS & POST
INTERSPACES

W = width (x2)* | HC = hinge clearance (x2)
LC = latch clearance | P_d = gate post spacing**
* From outside to outside | ** From inside to inside

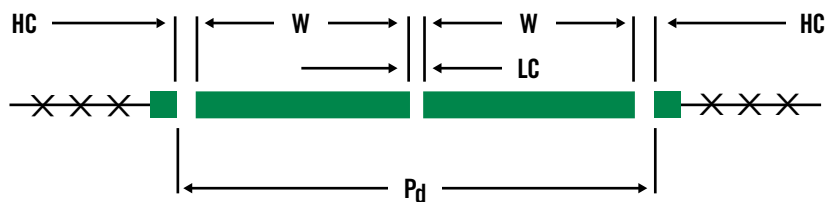

Effective: 01/06/15

AEGIS II® | 2-RAIL SWING GATES

4" AIR GAP | STANDARD BOTTOM | GATE HARDWARE SOLD SEPARATELY

	OPENING	LEAF WIDTH	ITEM NUMBER	PICKET QTY	WEIGHT	STOCKING
3' HEIGHT	3.5'	40.25"	2☒⊗2034-42	7	53 lbs	☉
	4'	49.5"	2☒⊗2034-48	9	63 lbs	☉
	5'	59"	2☒⊗2034-60	11	73 lbs	☉
	6'	68.5"	2☒⊗2034-72	13	84 lbs	☉
	7'	78"	2☒⊗2034-84	15	94 lbs	☉
	8'	96.75"	2☒⊗2034-96	19	104 lbs	☉
	9'	106.25"	2☒⊗2034-108	21	125 lbs	☉
	10'	115.5"	2☒⊗2034-120	23	136 lbs	☉
	11'	134.5"	2☒⊗2034-132	27	144 lbs	☉
	12'	143.75"	2☒⊗2034-144	29	154 lbs	☉
	13'	153.25"	2☒⊗2034-156	31	165 lbs	☉
	14'	162.75"	2☒⊗2034-168	33	190 lbs	☉
15'	181.5"	2☒⊗2034-180	37	195 lbs	☉	
16'	191"	2☒⊗2034-192	39	205 lbs	☉	
3½' HEIGHT	3.5'	40.25"	2☒⊗2040-42	7	58 lbs	☉
	4'	49.5"	2☒⊗2040-48	9	69 lbs	☉
	5'	59"	2☒⊗2040-60	11	80 lbs	☉
	6'	68.5"	2☒⊗2040-72	13	92 lbs	☉
	7'	78"	2☒⊗2040-84	15	103 lbs	☉
	8'	96.75"	2☒⊗2040-96	19	114 lbs	☉
	9'	106.25"	2☒⊗2040-108	21	137 lbs	☉
	10'	115.5"	2☒⊗2040-120	23	148 lbs	☉
	11'	134.5"	2☒⊗2040-132	27	158 lbs	☉
	12'	143.75"	2☒⊗2040-144	29	169 lbs	☉
	13'	153.25"	2☒⊗2040-156	31	180 lbs	☉
	14'	162.75"	2☒⊗2040-168	33	207 lbs	☉
15'	181.5"	2☒⊗2040-180	37	213 lbs	☉	
16'	191"	2☒⊗2040-192	39	224 lbs	☉	
4' HEIGHT	3.5'	40.25"	2☒⊗2048-42	7	63 lbs	☉
	4'	49.5"	2☒⊗2048-48	9	75 lbs	☉
	5'	59"	2☒⊗2048-60	11	87 lbs	☉
	6'	68.5"	2☒⊗2048-72	13	99 lbs	☉
	7'	78"	2☒⊗2048-84	15	112 lbs	☉
	8'	96.75"	2☒⊗2048-96	19	124 lbs	☉
	9'	106.25"	2☒⊗2048-108	21	148 lbs	☉
10'	115.5"	2☒⊗2048-120	23	160 lbs	☉	

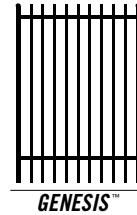
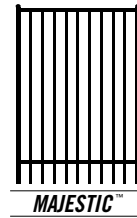
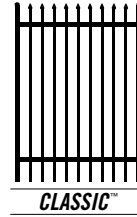

ADDITIONAL 4', 5', 6', 7', 8', 9' & 10' HEIGHTS CONTINUED ON NEXT PAGES

Effective: 01/06/15

AEGIS II® | 2-RAIL SWING GATES

4" AIR GAP | STANDARD BOTTOM | GATE HARDWARE SOLD SEPARATELY

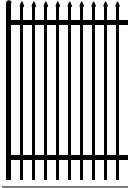
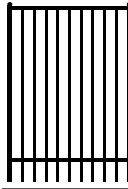
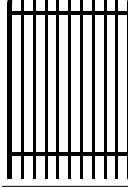
	OPENING	LEAF WIDTH	ITEM NUMBER	PICKET QTY	WEIGHT	STOCKING	
4' HEIGHT	11'	134.5"	2☒⊗2048-132	27	171 lbs	☉	 CLASSIC™
	12'	143.75"	2☒⊗2048-144	29	183 lbs	☉	
	13'	153.25"	2☒⊗2048-156	31	195 lbs	☉	
	14'	162.75"	2☒⊗2048-168	33	224 lbs	☉	
	15'	181.5"	2☒⊗2048-180	37	231 lbs	☉	
	16'	191"	2☒⊗2048-192	39	243 lbs	☉	
5' HEIGHT	3.5'	40.25"	2☒⊗2058-42	7	73 lbs	☉	 MAJESTIC™
	4'	49.5"	2☒⊗2058-48	9	87 lbs	☉	
	5'	59"	2☒⊗2058-60	11	101 lbs	☉	
	6'	68.5"	2☒⊗2058-72	13	114 lbs	☉	
	7'	78"	2☒⊗2058-84	15	130 lbs	☉	
	8'	96.75"	2☒⊗2058-96	19	144 lbs	☉	
	9'	106.25"	2☒⊗2058-108	21	171 lbs	☉	
	10'	115.5"	2☒⊗2058-120	23	184 lbs	☉	
	11'	134.5"	2☒⊗2058-132	27	198 lbs	☉	
	12'	143.75"	2☒⊗2058-144	29	212 lbs	☉	
6' HEIGHT	13'	153.25"	2☒⊗2058-156	31	225 lbs	☉	 GENESIS™
	14'	162.75"	2☒⊗2058-168	33	258 lbs	☉	
	15'	181.5"	2☒⊗2058-180	37	267 lbs	☉	
	16'	191"	2☒⊗2058-192	39	281 lbs	☉	
	3.5'	40.25"	2☒⊗2070-42	7	84 lbs	☉	
	4'	49.5"	2☒⊗2070-48	9	99 lbs	☉	
	5'	59"	2☒⊗2070-60	11	115 lbs	☉	
	6'	68.5"	2☒⊗2070-72	13	130 lbs	☉	
	7'	78"	2☒⊗2070-84	15	147 lbs	☉	
	8'	96.75"	2☒⊗2070-96	19	163 lbs	☉	
9'	106.25"	2☒⊗2070-108	21	194 lbs	☉		
10'	115.5"	2☒⊗2070-120	23	209 lbs	☉		
11'	134.5"	2☒⊗2070-132	27	225 lbs	☉		
12'	143.75"	2☒⊗2070-144	29	252 lbs	☉		
13'	153.25"	2☒⊗2070-156	31	255 lbs	☉		
14'	162.75"	2☒⊗2070-168	33	292 lbs	☉		
15'	181.5"	2☒⊗2070-180	37	303 lbs	☉		
16'	191"	2☒⊗2070-192	39	324 lbs	☉		

7', 8', 9' & 10' HEIGHTS CONTINUED ON NEXT PAGES

Effective: 01/06/15

AEGIS II® | 2-RAIL SWING GATES

4" AIR GAP | STANDARD BOTTOM | GATE HARDWARE SOLD SEPARATELY

	OPENING	LEAF WIDTH	ITEM NUMBER	PICKET QTY	WEIGHT	STOCKING
7' HEIGHT	3.5'	40.25" / 40"†	2☒☒2082-42	7 / 8†	94 / 99†	☉
	4'	49.5" / 44.75"†	2☒☒2082-48	9 / 9†	111 / 117†	☉
	5'	59" / 58.875"†	2☒☒2082-60	11 / 12†	128 / 137†	☉
	6'	68.5" / 68.25"†	2☒☒2082-72	13 / 14†	146 / 155†	☉
	7'	78" / 82.375"†	2☒☒2082-84	15 / 17†	165 / 175†	☉
	8'	96.75" / 91.875"†	2☒☒2082-96	19 / 19†	182 / 195†	☉
	9'	106.25" / 106"†	2☒☒2082-108	21 / 22†	217 / 226†	☉
	10'	115.5" / 115.375"†	2☒☒2082-120	23 / 24†	234 / 246†	☉
	11'	134.5" / 129.5"†	2☒☒2082-132	27 / 27†	251 / 264†	☉
	12'	143.75" / 139"†	2☒☒2082-144	29 / 29†	268 / 288†	☉
	13'	153.25" / 153.125"†	2☒☒2082-156	31 / 32†	286 / 302†	☉
	14'	162.75" / 167.25"†	2☒☒2082-168	33 / 35†	370 / 334†	☉
15'	181.5" / 176.75"†	2☒☒2082-180	37 / 37†	344 / 355†	☉	
16'	191" / 190.875"†	2☒☒2082-192	39 / 40†	356 / 368†	☉	
8' HEIGHT	3.5'	40.25" / 40"†	2☒☒2094-42	7 / 8†	104 / 111†	☉
	4'	49.5" / 44.75"†	2☒☒2094-48	9 / 9†	123 / 138†	☉
	5'	59" / 58.875"†	2☒☒2094-60	11 / 12†	142 / 153†	☉
	6'	68.5" / 68.25"†	2☒☒2094-72	13 / 14†	161 / 173†	☉
	7'	78" / 82.375"†	2☒☒2094-84	15 / 17†	182 / 195†	☉
	8'	96.75" / 91.875"†	2☒☒2094-96	19 / 19†	201 / 225†	☉
	9'	106.25" / 106"†	2☒☒2094-108	21 / 22†	240 / 262†	☉
	10'	115.5" / 115.375"†	2☒☒2094-120	23 / 24†	259 / 289†	☉
	11'	134.5" / 129.5"†	2☒☒2094-132	27 / 27†	278 / 295†	☉
	12'	143.75" / 139"†	2☒☒2094-144	29 / 29†	297 / 315†	☉
	13'	153.25" / 153.125"†	2☒☒2094-156	31 / 32†	330 / 338†	☉
	14'	162.75" / 167.25"†	2☒☒2094-168	33 / 35†	360 / 374†	☉
15'	181.5" / 176.75"†	2☒☒2094-180	37 / 37†	374 / 396†	☉	
16'	191" / 190.875"†	2☒☒2094-192	39 / 40†	393 / 412†	☉	

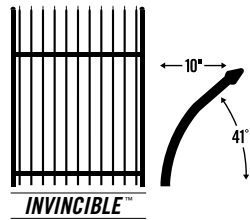
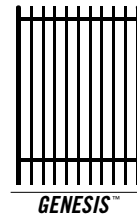
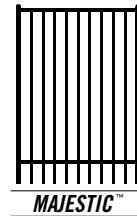
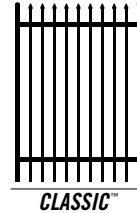

9' & 10' HEIGHTS CONTINUED ON NEXT PAGE

☒ = FENCE STYLES AVAILABLE | C = Classic M = Majestic G = Genesis I = Invincible†
 ☒ = COLOR OPTIONS AVAILABLE | B = Black N = Bronze W = White S = Sand
 ☉ = NON-STOCKED PRODUCT
 For details, see Ameristar's Sales Policy in the catalog guide.

Effective: 01/06/15

AEGIS II® | 2-RAIL SWING GATES

4" AIR GAP | STANDARD BOTTOM | GATE HARDWARE SOLD SEPARATELY

	OPENING	LEAF WIDTH	ITEM NUMBER	PICKET QTY	WEIGHT	STOCKING
9' HEIGHT	3.5'	40.25" / 40"†	2☒⊗2106-42	7 / 8†	114 / 119†	⊙
	4'	49.5" / 44.75"†	2☒⊗2106-48	9 / 9†	135 / 141†	⊙
	5'	59" / 58.875"†	2☒⊗2106-60	11 / 12†	156 / 165†	⊙
	6'	68.5" / 68.25"†	2☒⊗2106-72	13 / 14†	177 / 186†	⊙
	7'	78" / 82.375"†	2☒⊗2106-84	15 / 17†	200 / 210†	⊙
10' HEIGHT	8'	96.75" / 91.875"†	2☒⊗2106-96	19 / 19†	221 / 234†	⊙
	3.5'	40.25" / 40"†	2☒⊗2118-42	7 / 8†	124 / 130†	⊙
	4'	49.5" / 44.75"†	2☒⊗2118-48	9 / 9†	147 / 162†	⊙
	5'	59" / 58.875"†	2☒⊗2118-60	11 / 12†	170 / 179†	⊙
	6'	68.5" / 68.25"†	2☒⊗2118-72	13 / 14†	192 / 202†	⊙
7'	78" / 82.375"†	2☒⊗2118-84	15 / 17†	217 / 227†	⊙	
8'	96.75" / 91.875"†	2☒⊗2118-96	19 / 19†	240 / 262†	⊙	

☒ = FENCE STYLES AVAILABLE | C = Classic M = Majestic G = Genesis I = Invincible†

⊗ = COLOR OPTIONS AVAILABLE | B = Black N = Bronze W = White S = Sand

⊙ = NON-STOCKED PRODUCT

For details, see Ameristar's Sales Policy in the catalog guide.

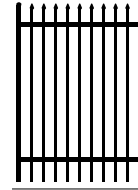

CLASSIC™

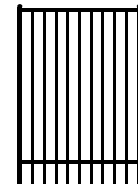

MAJESTIC™

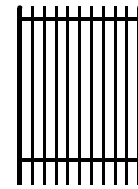

GENESIS™

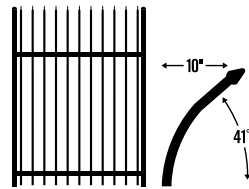









































































INVINCIBLE™

Effective: 01/06/15

AEGIS II® | 3-RAIL SWING GATES

4" AIR GAP | STANDARD BOTTOM | GATE HARDWARE SOLD SEPARATELY

	OPENING	LEAF WIDTH	ITEM NUMBER	PICKET QTY	WEIGHT	STOCKING
3' HEIGHT	3.5'	40.25"	2   3034-42	7	64 lbs	⊙
	4'	49.5"	2   3034-48	9	76 lbs	⊙
	5'	59"	2   3034-60	11	88 lbs	⊙
	6'	68.5"	2   3034-72	13	100 lbs	⊙
	7'	78"	2   3034-84	17	114 lbs	⊙
	8'	96.75"	2   3034-96	19	126 lbs	⊙
	9'	106.25"	2   3034-108	21	152 lbs	⊙
	10'	115.5"	2   3034-120	23	164 lbs	⊙
	11'	134.5"	2   3034-132	27	176 lbs	⊙
	12'	143.75"	2   3034-144	29	188 lbs	⊙
	13'	153.25"	2   3034-156	31	202 lbs	⊙
	14'	162.75"	2   3034-168	35	234 lbs	⊙
3½' HEIGHT	15'	181.5"	2   3034-180	37	239 lbs	⊙
	16'	191"	2   3034-192	39	251 lbs	⊙
	3.5'	40.25"	2   3040-42	7	69 lbs	⊙
	4'	49.5"	2   3040-48	9	82 lbs	⊙
	5'	59"	2   3040-60	11	95 lbs	⊙
	6'	68.5"	2   3040-72	13	108 lbs	⊙
	7'	78"	2   3040-84	17	123 lbs	⊙
	8'	96.75"	2   3040-96	19	136 lbs	⊙
	9'	106.25"	2   3040-108	21	164 lbs	⊙
	10'	115.5"	2   3040-120	23	177 lbs	⊙
	11'	134.5"	2   3040-132	27	190 lbs	⊙
	12'	143.75"	2   3040-144	29	203 lbs	⊙
13'	153.25"	2   3040-156	31	217 lbs	⊙	
14'	162.75"	2   3040-168	35	251 lbs	⊙	
4' HEIGHT	15'	181.5"	2   3040-180	37	257 lbs	⊙
	16'	191"	2   3040-192	39	270 lbs	⊙
	3.5'	40.25"	2   3048-42	7	74 lbs	⊙
	4'	49.5"	2   3048-48	9	88 lbs	⊙
	5'	59"	2   3048-60	11	102 lbs	⊙
	6'	68.5"	2   3048-72	13	116 lbs	⊙
	7'	78"	2   3048-84	17	132 lbs	⊙
	8'	96.75"	2   3048-96	19	146 lbs	⊙
9'	106.25"	2   3048-108	21	175 lbs	⊙	
10'	115.5"	2   3048-120	23	189 lbs	⊙	

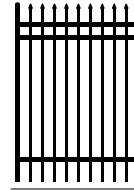

CLASSIC™

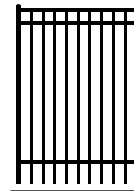

MAJESTIC™

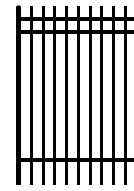

GENESIS™

ADDITIONAL 4', 5', 6', 7', 8', 9' & 10' HEIGHTS CONTINUED ON NEXT PAGES

Effective: 01/06/15

AEGIS II® | 3-RAIL SWING GATES

4" AIR GAP | STANDARD BOTTOM | GATE HARDWARE SOLD SEPARATELY

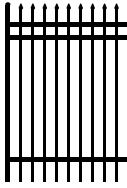
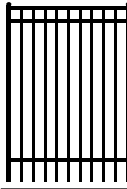
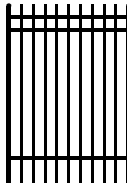
	OPENING	LEAF WIDTH	ITEM NUMBER	PICKET QTY	WEIGHT	STOCKING	
4' HEIGHT	11'	134.5"	2☒⊗3048-132	27	203 lbs	☉	 CLASSIC™
	12'	143.75"	2☒⊗3048-144	29	217 lbs	☉	
	13'	153.25"	2☒⊗3048-156	31	232 lbs	☉	
	14'	162.75"	2☒⊗3048-168	35	268 lbs	☉	
	15'	181.5"	2☒⊗3048-180	37	275 lbs	☉	
	16'	191"	2☒⊗3048-192	39	289 lbs	☉	
5' HEIGHT	3.5'	40.25"	2☒⊗3058-42	7	84 lbs	☉	 MAJESTIC™
	4'	49.5"	2☒⊗3058-48	9	100 lbs	☉	
	5'	59"	2☒⊗3058-60	11	116 lbs	☉	
	6'	68.5"	2☒⊗3058-72	13	132 lbs	☉	
	7'	78"	2☒⊗3058-84	17	150 lbs	☉	
	8'	96.75"	2☒⊗3058-96	19	166 lbs	☉	
	9'	106.25"	2☒⊗3058-108	21	198 lbs	☉	
	10'	115.5"	2☒⊗3058-120	23	214 lbs	☉	
	11'	134.5"	2☒⊗3058-132	27	230 lbs	☉	
	12'	143.75"	2☒⊗3058-144	29	246 lbs	☉	
6' HEIGHT	13'	153.25"	2☒⊗3058-156	31	262 lbs	☉	 GENESIS™
	14'	162.75"	2☒⊗3058-168	35	302 lbs	☉	
	15'	181.5"	2☒⊗3058-180	37	311 lbs	☉	
	16'	191"	2☒⊗3058-192	39	327 lbs	☉	
	3.5'	40.25"	2☒⊗3070-42	7	94 lbs	☉	
	4'	49.5"	2☒⊗3070-48	9	112 lbs	☉	
	5'	59"	2☒⊗3070-60	11	130 lbs	☉	
	6'	68.5"	2☒⊗3070-72	13	147 lbs	☉	
	7'	78"	2☒⊗3070-84	17	167 lbs	☉	
	8'	96.75"	2☒⊗3070-96	19	185 lbs	☉	
9'	106.25"	2☒⊗3070-108	21	221 lbs	☉		
10'	115.5"	2☒⊗3070-120	23	239 lbs	☉		
11'	134.5"	2☒⊗3070-132	27	256 lbs	☉		
12'	143.75"	2☒⊗3070-144	29	286 lbs	☉		
13'	153.25"	2☒⊗3070-156	31	292 lbs	☉		
14'	162.75"	2☒⊗3070-168	35	336 lbs	☉		
15'	181.5"	2☒⊗3070-180	37	347 lbs	☉		
16'	191"	2☒⊗3070-192	39	370 lbs	☉		

7', 8', 9' & 10' HEIGHTS CONTINUED ON NEXT PAGES

Effective: 01/06/15

AEGIS II® | 3-RAIL SWING GATES

4" AIR GAP | STANDARD BOTTOM | GATE HARDWARE SOLD SEPARATELY

	OPENING	LEAF WIDTH	ITEM NUMBER	PICKET QTY	WEIGHT	STOCKING
7' HEIGHT	3.5'	40.25" / 40"†	2☒☒3082-42	7 / 8†	104 / 110†	☉
	4'	49.5" / 44.75"†	2☒☒3082-48	9 / 9†	124 / 137†	☉
	5'	59" / 58.875"†	2☒☒3082-60	11 / 12†	143 / 160†	☉
	6'	68.5" / 68.25"†	2☒☒3082-72	13 / 14†	163 / 181†	☉
	7'	78" / 82.375"†	2☒☒3082-84	15 / 17†	185 / 197†	☉
	8'	96.75" / 91.875"†	2☒☒3082-96	19 / 19†	204 / 221†	☉
	9'	106.25" / 106"†	2☒☒3082-108	21 / 22†	244 / 261†	☉
	10'	115.5" / 115.375"†	2☒☒3082-120	23 / 24†	263 / 285†	☉
	11'	134.5" / 129.5"†	2☒☒3082-132	27 / 27†	283 / 305†	☉
	12'	143.75" / 139"†	2☒☒3082-144	29 / 29†	303 / 320†	☉
	13'	153.25" / 153.125"†	2☒☒3082-156	31 / 32†	322 / 349†	☉
	14'	162.75" / 167.25"†	2☒☒3082-168	33 / 35†	370 / 390†	☉
8' HEIGHT	15'	181.5" / 176.75"†	2☒☒3082-180	37 / 37†	382 / 401†	☉
	16'	191" / 190.875"†	2☒☒3082-192	39 / 40†	402 / 414†	☉
	3.5'	40.25" / 40"†	2☒☒3094-42	7 / 8†	114 / 129†	☉
	4'	49.5" / 44.75"†	2☒☒3094-48	9 / 9†	136 / 151†	☉
	5'	59" / 58.875"†	2☒☒3094-60	11 / 12†	157 / 177†	☉
	6'	68.5" / 68.25"†	2☒☒3094-72	13 / 14†	179 / 200†	☉
	7'	78" / 82.375"†	2☒☒3094-84	15 / 17†	202 / 217†	☉
	8'	96.75" / 91.875"†	2☒☒3094-96	19 / 19†	224 / 250†	☉
	9'	106.25" / 106"†	2☒☒3094-108	21 / 22†	267 / 281†	☉
	10'	115.5" / 115.375"†	2☒☒3094-120	23 / 24†	288 / 315†	☉
	11'	134.5" / 129.5"†	2☒☒3094-132	27 / 27†	310 / 329†	☉
	12'	143.75" / 139"†	2☒☒3094-144	29 / 29†	345 / 353†	☉
13'	153.25" / 153.125"†	2☒☒3094-156	31 / 32†	352 / 386†	☉	
14'	162.75" / 167.25"†	2☒☒3094-168	33 / 35†	404 / 416†	☉	
15'	181.5" / 176.75"†	2☒☒3094-180	37 / 37†	418 / 442†	☉	
16'	191" / 190.875"†	2☒☒3094-192	39 / 40†	439 / 466†	☉	

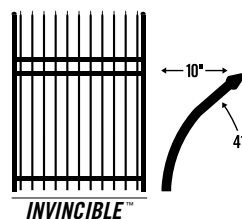
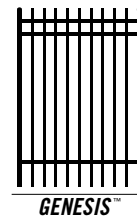
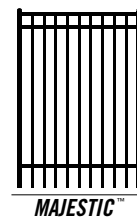
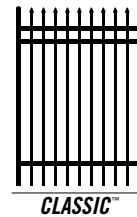

9' & 10' HEIGHTS CONTINUED ON NEXT PAGE

☒ = FENCE STYLES AVAILABLE | C = Classic M = Majestic G = Genesis I = Invincible†

☒ = COLOR OPTIONS AVAILABLE | B = Black N = Bronze W = White S = Sand

☉ = NON-STOCKED PRODUCT

For details, see Ameristar's Sales Policy in the catalog guide.

Effective: 01/06/15

AEGIS II® | 3-RAIL SWING GATES

4" AIR GAP | STANDARD BOTTOM | GATE HARDWARE SOLD SEPARATELY

	OPENING	LEAF WIDTH	ITEM NUMBER	PICKET QTY	WEIGHT	STOCKING
9' HEIGHT	3.5'	40.25" / 40"†	2☒⊗3106-42	7 / 8†	124 / 139†	⊙
	4'	49.5" / 44.75"†	2☒⊗3106-48	9 / 9†	148 / 154†	⊙
	5'	59" / 58.875"†	2☒⊗3106-60	11 / 12†	171 / 182†	⊙
	6'	68.5" / 68.25"†	2☒⊗3106-72	13 / 14†	194 / 206†	⊙
	7'	78" / 82.375"†	2☒⊗3106-84	15 / 17†	220 / 232†	⊙
10' HEIGHT	8'	96.75" / 91.875"†	2☒⊗3106-96	19 / 19†	243 / 259†	⊙
	3.5'	40.25" / 40"†	2☒⊗3118-42	7 / 8†	134 / 141†	⊙
	4'	49.5" / 44.75"†	2☒⊗3118-48	9 / 9†	160 / 175†	⊙
	5'	59" / 58.875"†	2☒⊗3118-60	11 / 12†	185 / 205†	⊙
	6'	68.5" / 68.25"†	2☒⊗3118-72	13 / 14†	210 / 222†	⊙
7'	78" / 82.375"†	2☒⊗3118-84	15 / 17†	237 / 249†	⊙	
8'	96" / 91.875"†	2☒⊗3118-96	19 / 19†	262 / 279†	⊙	

☒ = FENCE STYLES AVAILABLE | C = Classic M = Majestic G = Genesis I = Invincible†

⊗ = COLOR OPTIONS AVAILABLE | B = Black N = Bronze W = White S = Sand

⊙ = NON-STOCKED PRODUCT

For details, see Ameristar's Sales Policy in the catalog guide.

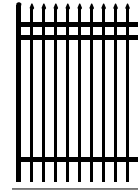

CLASSIC™

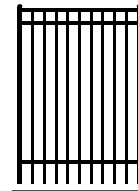

MAJESTIC™

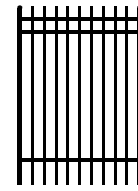

GENESIS™

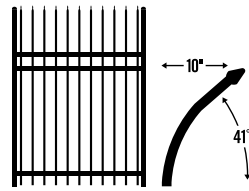

INVINCIBLE™

Effective: 01/06/15

AEGIS II® | 3-RAIL SWING GATES WITH RINGS

4" AIR GAP | STANDARD BOTTOM | GATE HARDWARE SOLD SEPARATELY

	OPENING	LEAF WIDTH	ITEM NUMBER	PICKET QTY	WEIGHT	STOCKING
3' HEIGHT	3.5'	40.25"	2☒☒3034-42R	7	68	☉
	4'	49.5"	2☒☒3034-48R	9	82	☉
	5'	59"	2☒☒3034-60R	11	95	☉
	6'	68.5"	2☒☒3034-72R	13	109	☉
	7'	78"	2☒☒3034-84R	15	124	☉
	8'	96.75"	2☒☒3034-96R	19	137	☉
	9'	106.25"	2☒☒3034-108R	21	164	☉
	10'	115.5"	2☒☒3034-120R	23	177	☉
	11'	134.5"	2☒☒3034-132R	27	197	☉
	12'	143.75"	2☒☒3034-144R	29	210	☉
	13'	153.25"	2☒☒3034-156R	31	226	☉
	14'	162.75"	2☒☒3034-168R	33	254	☉
3½' HEIGHT	15'	181.5"	2☒☒3034-180R	37	250	☉
	16'	191"	2☒☒3034-192R	39	255	☉
	3.5'	40.25"	2☒☒3040-42R	7	73	☉
	4'	49.5"	2☒☒3040-48R	9	88	☉
	5'	59"	2☒☒3040-60R	11	102	☉
	6'	68.5"	2☒☒3040-72R	13	117	☉
	7'	78"	2☒☒3040-84R	15	133	☉
	8'	96.75"	2☒☒3040-96R	19	147	☉
	9'	106.25"	2☒☒3040-108R	21	175	☉
	10'	115.5"	2☒☒3040-120R	23	189	☉
	11'	134.5"	2☒☒3040-132R	27	211	☉
	12'	143.75"	2☒☒3040-144R	29	225	☉
13'	153.25"	2☒☒3040-156R	31	242	☉	
14'	162.75"	2☒☒3040-168R	33	271	☉	
4' HEIGHT	15'	181.5"	2☒☒3040-180R	37	275	☉
	16'	191"	2☒☒3040-192R	39	282	☉
	3.5'	40.25"	2☒☒3048-42R	7	78	☉
	4'	49.5"	2☒☒3048-48R	9	94	☉
	5'	59"	2☒☒3048-60R	11	109	☉
	6'	68.5"	2☒☒3048-72R	13	124	☉
	7'	78"	2☒☒3048-84R	15	142	☉
8'	96.75"	2☒☒3048-96R	19	157	☉	
9'	106.25"	2☒☒3048-108R	21	186	☉	
10'	115.5"	2☒☒3048-120R	23	201	☉	

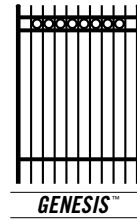
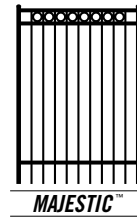
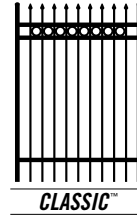

ADDITIONAL 4', 5', 6', 7', 8', 9' & 10' HEIGHTS CONTINUED ON NEXT PAGES

Effective: 01/06/15

AEGIS II® | 3-RAIL SWING GATES WITH RINGS

4" AIR GAP | STANDARD BOTTOM | GATE HARDWARE SOLD SEPARATELY

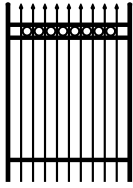
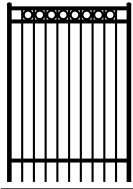
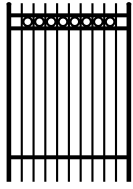



















































































	OPENING	LEAF WIDTH	ITEM NUMBER	PICKET QTY	WEIGHT	STOCKING	
4' HEIGHT	11'	134.5"	2☒⊗3048-132R	27	225	☉	 CLASSIC™
	12'	143.75"	2☒⊗3048-144R	29	240	☉	
	13'	153.25"	2☒⊗3048-156R	31	257	☉	
	14'	162.75"	2☒⊗3048-168R	33	287	☉	
	15'	181.5"	2☒⊗3048-180R	37	300	☉	
	16'	191"	2☒⊗3048-192R	39	315	☉	
5' HEIGHT	3.5'	40.25"	2☒⊗3058-42R	7	88	☉	 MAJESTIC™
	4'	49.5"	2☒⊗3058-48R	9	106	☉	
	5'	59"	2☒⊗3058-60R	11	123	☉	
	6'	68.5"	2☒⊗3058-72R	13	139	☉	
	7'	78"	2☒⊗3058-84R	15	160	☉	
	8'	96.75"	2☒⊗3058-96R	19	177	☉	
	9'	106.25"	2☒⊗3058-108R	21	208	☉	
	10'	115.5"	2☒⊗3058-120R	23	225	☉	
	11'	134.5"	2☒⊗3058-132R	27	253	☉	
	12'	143.75"	2☒⊗3058-144R	29	270	☉	
6' HEIGHT	13'	153.25"	2☒⊗3058-156R	31	288	☉	 GENESIS™
	14'	162.75"	2☒⊗3058-168R	33	320	☉	
	15'	181.5"	2☒⊗3058-180R	37	350	☉	
	16'	191"	2☒⊗3058-192R	39	381	☉	
	3.5'	40.25"	2☒⊗3070-42R	7	98	☉	
	4'	49.5"	2☒⊗3070-48R	9	118	☉	
	5'	59"	2☒⊗3070-60R	11	137	☉	
	6'	68.5"	2☒⊗3070-72R	13	155	☉	
	7'	78"	2☒⊗3070-84R	15	177	☉	
	8'	96.75"	2☒⊗3070-96R	19	196	☉	
9'	106.25"	2☒⊗3070-108R	21	230	☉		
10'	115.5"	2☒⊗3070-120R	23	249	☉		
11'	134.5"	2☒⊗3070-132R	27	280	☉		
12'	143.75"	2☒⊗3070-144R	29	299	☉		
13'	153.25"	2☒⊗3070-156R	31	319	☉		
14'	162.75"	2☒⊗3070-168R	33	353	☉		
15'	181.5"	2☒⊗3070-180R	37	372	☉		
16'	191"	2☒⊗3070-192R	39	428	☉		

7', 8', 9' & 10' HEIGHTS CONTINUED ON NEXT PAGES

Effective: 01/06/15

AEGIS II® | 3-RAIL SWING GATES WITH RINGS

4" AIR GAP | STANDARD BOTTOM | GATE HARDWARE SOLD SEPARATELY

	OPENING	LEAF WIDTH	ITEM NUMBER	PICKET QTY	WEIGHT	STOCKING
7' HEIGHT	3.5'	40.25"	2   3082-42R	7	108	
	4'	49.5"	2   3082-48R	9	130	
	5'	59"	2   3082-60R	11	150	
	6'	68.5"	2   3082-72R	13	171	
	7'	78"	2   3082-84R	15	195	
	8'	96.75"	2   3082-96R	19	215	
	9'	106.25"	2   3082-108R	21	253	
	10'	115.5"	2   3082-120R	23	273	
	11'	134.5"	2   3082-132R	27	307	
	12'	143.75"	2   3082-144R	29	328	
	13'	153.25"	2   3082-156R	31	349	
	14'	162.75"	2   3082-168R	33	387	
8' HEIGHT	15'	181.5"	2   3082-180R	37	407	
	16'	191"	2   3082-192R	39	428	
	3.5'	40.25"	2   3094-42R	7	118	
	4'	49.5"	2   3094-48R	9	142	
	5'	59"	2   3094-60R	11	164	
	6'	68.5"	2   3094-72R	13	187	
	7'	78"	2   3094-84R	15	212	
	8'	96.75"	2   3094-96R	19	235	
	9'	106.25"	2   3094-108R	21	275	
	10'	115.5"	2   3094-120R	23	297	
	11'	134.5"	2   3094-132R	27	335	
	12'	143.75"	2   3094-144R	29	357	
13'	153.25"	2   3094-156R	31	380		
14'	162.75"	2   3094-168R	33	420		
15'	181.5"	2   3094-180R	37	443		
16'	191"	2   3094-192R	39	465		

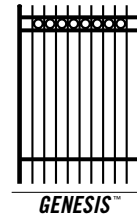
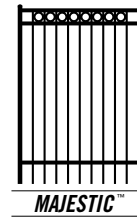
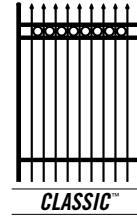

9' & 10' HEIGHTS CONTINUED ON NEXT PAGE

 = FENCE STYLES AVAILABLE | **C** = Classic **M** = Majestic **G** = Genesis

 = COLOR OPTIONS AVAILABLE | **B** = Black **N** = Bronze **W** = White **S** = Sand

 = NON-STOCKED PRODUCT

For details, see Ameristar's Sales Policy in the catalog guide.

Effective: 01/06/15

AEGIS II® | 3-RAIL SWING GATES WITH RINGS

4" AIR GAP | STANDARD BOTTOM | GATE HARDWARE SOLD SEPARATELY

	OPENING	LEAF WIDTH	ITEM NUMBER	PICKET QTY	WEIGHT	STOCKING
9' HEIGHT	3.5'	40.25"	2☒⊗3106-42R	7	128	⊙
	4'	49.5"	2☒⊗3106-48R	9	154	⊙
	5'	59"	2☒⊗3106-60R	11	178	⊙
	6'	68.5"	2☒⊗3106-72R	13	202	⊙
	7'	78"	2☒⊗3106-84R	15	230	⊙
	8'	96.75"	2☒⊗3106-96R	19	254	⊙
10' HEIGHT	3.5'	40.25"	2☒⊗3118-42R	21	138	⊙
	4'	49.5"	2☒⊗3118-48R	23	166	⊙
	5'	59"	2☒⊗3118-60R	27	192	⊙
	6'	68.5"	2☒⊗3118-72R	29	218	⊙
	7'	78"	2☒⊗3118-84R	31	247	⊙
	8'	96.75"	2☒⊗3118-96R	35	273	⊙

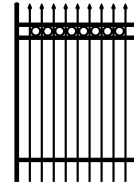

CLASSIC™

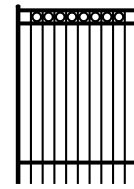

MAJESTIC™

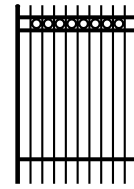

GENESIS™

☒ = FENCE STYLES AVAILABLE | C = Classic | M = Majestic | G = Genesis
 ⊗ = COLOR OPTIONS AVAILABLE | B = Black | N = Bronze | W = White | S = Sand
 ⊙ = NON-STOCKED PRODUCT
 For details, see Ameristar's Sales Policy in the catalog guide.

Effective: 01/06/15

AEGIS II® | **AEGIS PLUS**® | **AEGIS**®

AEGIS II® | **INDUSTRIAL ORNAMENTAL STEEL FENCE**

Effective: 01/06/15

AMERISTAR
ASSA ABLOY

| **TO PLACE YOUR ORDER CALL 888-333-3422** | **VISIT AMERISTARFENCE.COM**

Effective: 01/06/15

TO PLACE YOUR ORDER CALL 888-333-3422 | VISIT AMERISTARFENCE.COM |

AMERISTAR
ASSA ABLOY

AEGIS II® | **AEGIS PLUS**® | **AEGIS**®

AEGIS II® | **INDUSTRIAL ORNAMENTAL STEEL FENCE**

Effective: 01/06/15

AMERISTAR
ASSA ABLOY

| **TO PLACE YOUR ORDER CALL 888-333-3422** | **VISIT AMERISTARFENCE.COM**