

32 31 00/AME  
BuyLine 5862



**Ornamental Steel and Aluminum  
Ornamental Welded  
Engineered Gate Systems**

**Ameristar Fence Products**  
Architectural Metal Fences & Gates

# DEFINING FEATURES

Any truly great product must have a defining feature that sets it apart from all others; Ameristar® fence systems have several features that make them superior to those of competing manufacturers.

## DESIGN INNOVATION

Ameristar® has developed unique (patented or patents pending) product designs that simultaneously expand structural capabilities and increase aesthetic value of its architectural fence systems.

### FORERUNNER™ RAIL

The primary differentiating factor in Ameristar's Aegis II®, Aegis Plus®, and Echelon II® ornamental fence systems is the ForeRunner™ internal retaining rod picket-to-rail joining system. Panels employing this unique system present an attractive "good neighbor" look with no exposed fasteners.

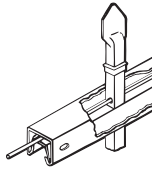

Aegis II® and Aegis Plus®  
(Pages 4 and 5)

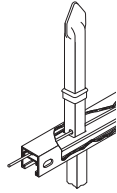

Echelon II®  
(Pages 8 and 9)

### DESIGN ADVANTAGES

#### • All Terrain Fence (ATF)® Panel Design

Architectural design and construction technology have progressed to enable new facility construction on rough and uneven terrain that was previously considered feasible for permanent structures. Montage Plus® ATF maintains its rigid strength, while adapting to slopes as severe as a 48 inch rise in an 8 foot run.



## SUPERIOR COATING PROCESS

Impasse® High Security Fences, Aegis II® Industrial Ornamental Steel Fences, Aegis Plus® Commercial Ornamental Steel Fences, and PermaCoat® Industrial and Commercial Color Chain Link Framework are all protected with Ameristar's unique PermaCoat double coating process (see Page 3 for details on process). The steel base material has a hot-dip galvanized coating, specially developed for subsequent application of powder coating. The galvanized substrate is subjected to the PermaCoat® process, a complete thermal stratification (multi-stage, high-temperature, multi-layer) electrostatic powder application system of both epoxy and polyester. The PermaCoat® powder coating system results in finished surfaces with unmatched performance. The base coat of epoxy powder far surpasses the corrosion resisting abilities of painted surfaces. The "no-mar" polyester powder top coat dramatically increases weathering resistance (color and gloss retention) and reduces scratches and burnishing marks normally encountered during shipping.

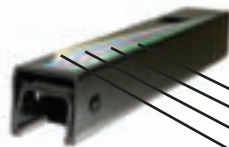

Aegis II® and Aegis Plus®  
(Pages 4 Through 5)

Galvanized Steel  
Zinc Phosphate  
Epoxy Powder Coat  
"No-Mar" Polyester Color Coat

## COMPREHENSIVE TECHNICAL SUPPORT

### Architectural Binder

The shop drawing shown is one of several shop drawings contained in the Ameristar® Architectural Binder, which is available upon request. Ameristar's standard technical information in the form of drawings, specifications, photographic examples, and warranties, is provided in hard copy

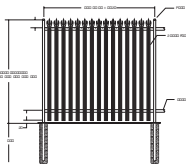

format. The binder addresses all Ameristar® high security, industrial, and commercial architectural metal fence and gate systems including Impasse®, Stalwart®, Aegis®, Montage Plus® and Echelon®, as well as PermaCoat® and GalvOnAll™ chain link fence products.

### Architectural DVD

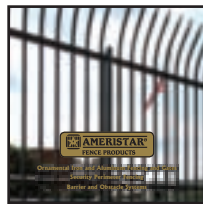

photographs and electronic specifications and drawings pertaining to all of Ameristar's architectural metal fence and gate systems, as well as relevant data on the multi-stage electrostatic coating process for high security and industrial/commercial applications.

### Internet Website

The Ameristar® architectural website (<http://www.ameristarfence.com>) enables the user to browse the entire Ameristar® product line. The site is complete with photos, drawings, specifications and installation procedures.

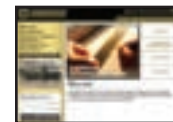

Ameristar's electronic media enable architects and specifiers to simply download specification information directly into the appropriate section of their CSI-formatted project specifications; they also enable the direct downloading of product drawings onto project blueprints.



# DEFINING FEATURES

32 31 00/AME  
BuyLine 5862

## SUPERIOR PERMACOAT® PROCESS

AMERISTAR®  
PERMACOAT®  
(DOUBLE COATED)

### 11 Stage PermaCoat® Double-Coating Process

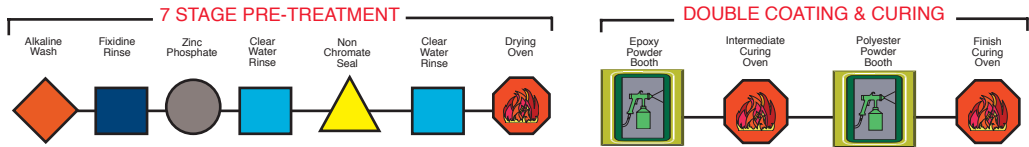

All fence parts, gates and accessories are given complete PermaCoat® application.

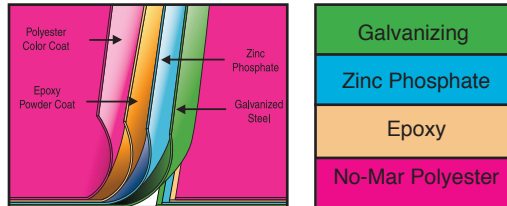

Zinc compounds are used in the phosphating process because they add a significant amount of sacrificial cathodic protection. The zinc is much more active than steel; therefore, the zinc must oxidize before the steel is free to corrode. Iron phosphate, by contrast, provides no sacrificial cathodic advantage when applied to steel.

## TYPICAL COMPETITOR PROCESSES

CONVENTIONAL  
POLYESTER  
(ONE COAT)

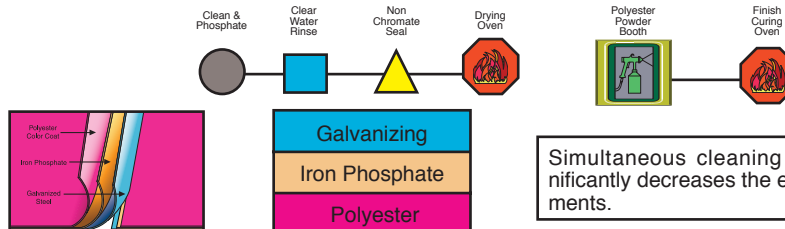

Simultaneous cleaning and phosphating significantly decreases the effectiveness of both treatments.

CONVENTIONAL  
PVC  
(ONE COAT)

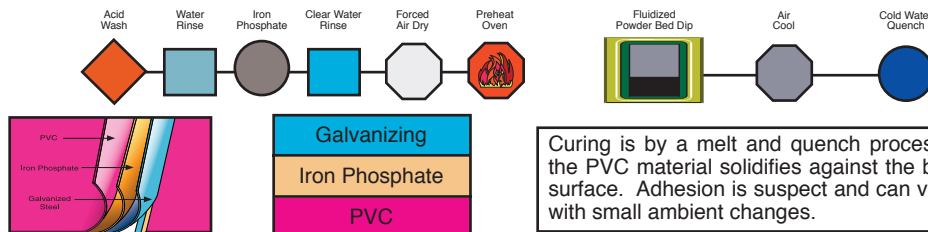

Curing is by a melt and quench process wherein the PVC material solidifies against the base metal surface. Adhesion is suspect and can vary greatly with small ambient changes.

PAINT  
SYSTEM

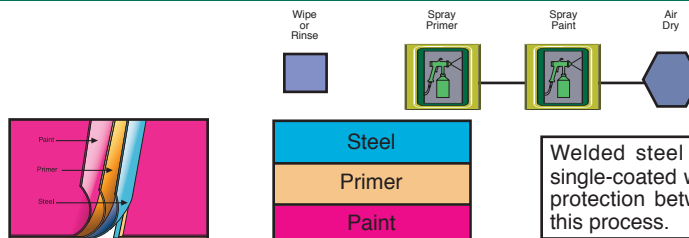

Welded steel fences are frequently painted or single-coated without pre-treatment. No transition protection between base material and paint with this process.

### SUPERIOR CORROSION RESISTANCE

PermaCoat® significantly exceeds paint, polyolefin, PVC, and one coat polyester finishes in its ability to resist corrosion. ASTM B117 test results below show the dramatic difference.

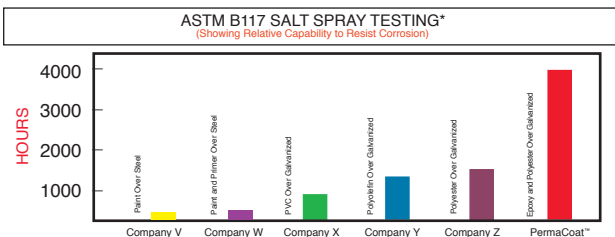

\* Testing to ASTM B-117 with scribe to ASTM D1654 - Failure mode of 1/8-inch undercut or medium #8 blisters.

### SUPERIOR UV RESISTANCE

PermaCoat® is far superior to PVC in resistance to the harmful effects of UV radiation, as shown below using South Florida exposure tests.

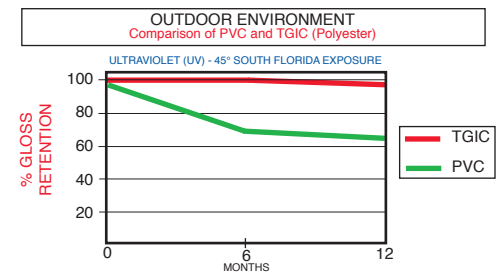

# AEGIS PLUS® AND AEGIS II®

## The Product Leader in Ornamental Fence

Aegis® - A revolutionary system of fence posts, framework and mounting accessories that are easily assembled to form an attractive “good neighbor” appearance with no exposed fasteners. Any truly great product must have a defining feature that sets it apart from all others; Ameristar’s Aegis® fences, including Aegis II® Industrial and Aegis Plus® Commercial, has two such features:

- **NO RIVETS**
- **NO SCREWS**
- **NO WELDS**

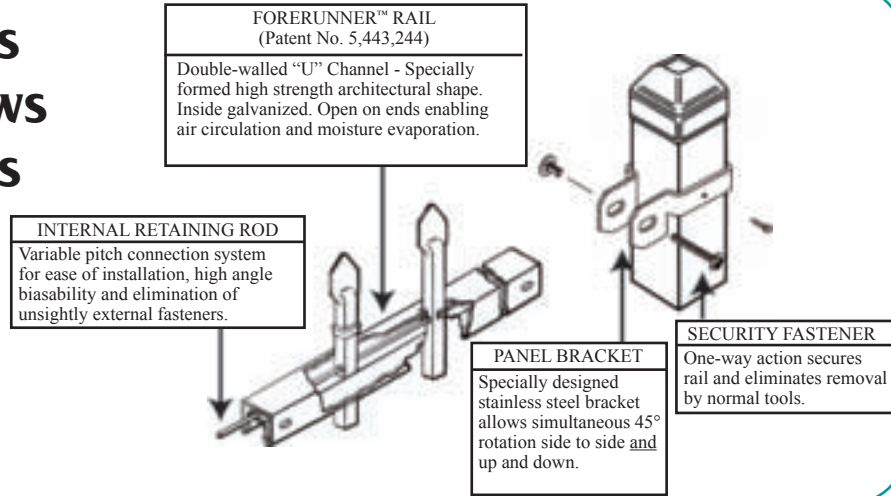

## RAIL STRENGTH

ForeRunner™ (Steel)	ForeRunner™ (Steel)	Structural Parameters	Square (Steel)	Square (Steel)	U-Channel (Steel)	U-Channel (Aluminum)			
		Profile of the Architectural Shape of the Rail *Vertical Design Loads are per rail; for capacity of fence panel, multiply by number of rails.							
.160	.160	$T_{eff}$ = Effective Wall Thickness (IN)	.083	.095	.120	.100/.070			
.1624	.1612	$S_v$ = Section Modulus (IN) Vertical	.188	.115	.0938	.1350			
.367	.254	$S_h$ = Section Modulus (IN) Horizontal	.309	.147	.210	.260			
2.55	2.13	$W$ = Rail Weight (LBS/FT)	2.11	1.75	1.68	0.54			
50,000	50,000	$F_y$ = Yield Strength (PSI)	50,000	50,000	45,000	35,000			
676#	652#	6' Span	Vertical Load Data $PV_f$ = Ultimate Vertical		6' Span	523#	320#	-----	262#
506#	492#	8' Span			8' Span	392#	239#	-----	229#
1,020#	639#	6' Span	Horizontal Load Data $PH_f$ = Ultimate Horizontal		6' Span	859#	409#	-----	482#
765#	482#	8' Span			8' Span	644#	306#	-----	438#
446#	430#	6' Span	* Vertical Load Data $PV_d$ = Vertical Design Load @ .66 $F_y$		6' Span	345#	211#	-----	173#
334#	325#	8' Span			8' Span	259#	158#	-----	151#
673#	422#	6' Span	* Horizontal Load Data $PH_d$ = Horizontal Design Load @ .66 $F_y$		6' Span	567#	270#	-----	318#
505#	318#	8' Span			8' Span	425#	202#	-----	289#

\* RECOMMENDED LOAD VALUE FOR SAFE STRUCTURAL DESIGN (Allowable Strength = .66  $F_y$ ).

## COMPONENT SIZES

System	Pickets	Rails
Aegis II® Industrial	1" x 14 GA.	1-3/4" x 14 GA. Double Wall
Aegis Plus® Commercial	3/4" x 17 GA.	1-1/2" x 14 GA.

\* Special Roll-Formed ForeRunner™ Shape

## COLORS

Request Color Chip samples for actual color



## ADORNMENTS

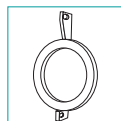
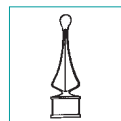

**Classic™**

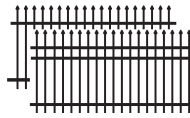

CLASSIC™  
Style C2 (2-Rail)  
Style C3 (3-Rail)

Ameristar's spear-pointed picket extends through the ForeRunner™ top rail to form the attractive traditional Classic™ design. The picket spear is formed with a 3/8" diameter rounded tip rather than a sharp point.

**Majestic™**

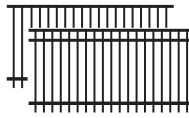

MAJESTIC™  
Style M2 (2-Rail)  
Style M3 (3-Rail)

The Majestic™ design maintains a stately look of dignity. The smooth clean lines of the Majestic™ style make it ideal for many contemporary applications. The Majestic™ style is a popular and safe perimeter for a pool area.

**Genesis™**

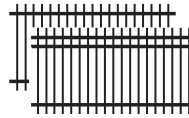

GENESIS™  
Style G2 (2-Rail)  
Style G3 (3-Rail)

The Genesis™ style offers extended pickets similar to the Classic™, but is differentiated by having a flat rather than spear-shaped picket top. Genesis™ is becoming increasingly popular as a perimeter for apartments and condominiums. Available in both 2 and 3-Rail styles. The Genesis™ style is base for adding decorative finials (see Adornments on Page 6).

**Invincible™**

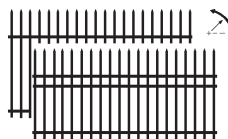

INVINCIBLE™ (Aegis II)  
Style I2 (2-Rail)  
Style I3 (3-Rail)

Security and protection are combined with the beauty of ornamental fencing in the Invincible™ design. Each picket is spear-topped and extends one foot above the top rail, curving outward to make this fence incapable of being overcome, as the name implies.

**Warrior™**

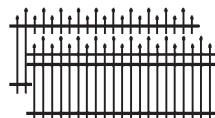
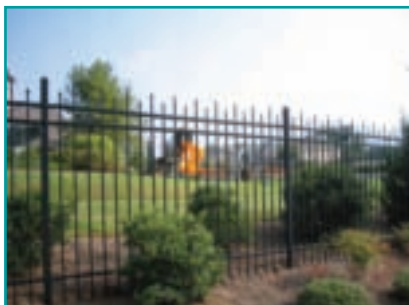

WARRIOR™ (Aegis Plus Only)  
Style W2 (2-Rail)  
Style W3 (3-Rail)

The extended spear pointed pickets of the Warrior™ style lend to their popularity for most traditional ornamental applications. Available in both 2 and 3-Rail styles.

# MONTAGE PLUS® AND MONTAGE II®

## Fusion Welded Steel Construction

Montage Plus® and Montage II® is crafted with an inherent beauty that adds a decorative touch to any landscape. The fusion welded steel construction makes it applicable for all types of heavy industrial applications and commercial installations such as retail businesses, storage facilities, schools, health care facilities and golf courses and recreational parks. The maintenance-free electro-deposition coating (E-Coat) makes Montage Plus® and Montage II® suitable for any climate, hot or cold, wet or dry; Ameristar® uses the same cyclic testing technology used in the automotive industry to ensure that the coating will withstand repeated shifts in temperature and humidity. The All Terrain Fence (ATF) design enables fence installation that follows significant grade changes (see Page 2).

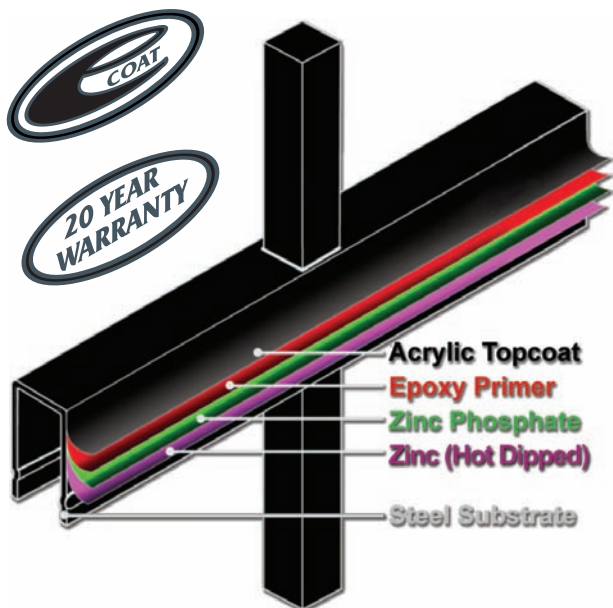

## COATING & WARRANTY

The E-Coat combination of galvanized steel, zinc phosphate pre-treatment, and epoxy and acrylic double coating provide the protection necessary to withstand adverse weathering effects and justify the 'best-in-the-business' 20 Year Warranty.

## COLORS, AVAILABILITY & MAINTENANCE

Montage Plus® is available in black or bronze. Color chip samples can be requested for actual color. Little or no maintenance is required as the E-coated components will remain corrosion-free for years to come. If coating is damaged by accidental impact, the affected components can be readily repaired with Ameristar's matching custom finishes (either spray or paint pen application). Montage Plus™ fence components are packaged as necessary to ensure damage-free shipping.

To order, simply specify the fence or gate design series, color and height desired. Then figure and provide the quantities needed. Contact Ameristar® for the nearest distributor.

## DESIGN OPTIONS

- **Pool, Pet & Play (PPP)® Picket Space Option**

In many cases related to child care, public swimming pools, and containment, a narrower space may be desired or required for added safety or security. Montage Plus® offers the optional 3" space.



- **Flush Bottom Rail Option**

For some applications, a flush bottom rail may be necessary to meet local building codes or simply to meet an aesthetic preference.



## COMPONENT SIZES

System	Height	Pickets	Rails
Montage Plus®	6' & UNDER	3/4" x 17 GA.	1-7/16" x 0.072" Top 1-1/2" x 0.072" Sides
	OVER 6'	3/4" x 14 GA.	1-7/16" x 0.072" Top 1-1/2" x 0.072" Sides
Montage II®	ALL HEIGHTS	1" x 14 GA.	1-3/4" x 0.105" Top 1-3/4" x 0.105" Sides

## ADORNMENTS



Quad Flare

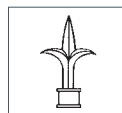

Triad

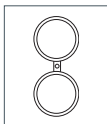

Ring



Ball Cap





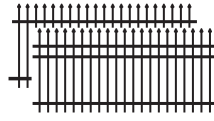

CLASSIC

Style C2 (2-Rail - 3', 3½', 4', 4½', 5' & 6')  
Style C3 (3-Rail - 3', 3½', 4', 4½', 5', 6', 7' & 8')  
Style C4 (4-Rail - 7' & 8')

**Classic™**

The extended spear top of the Classic™ style gives the secure structure an added touch of elegance. Classic™ is available in 2-rail, 3-rail and 4-rail designs.

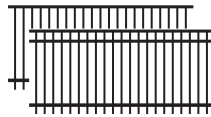

MAJESTIC

Style M2 (2-Rail - 3', 3½', 4', 4½', 5' & 6')  
Style M3 (3-Rail - 3', 3½', 4', 4½', 5', 6', 7' & 8')  
Style M4 (4-Rail - 7' & 8')

**Majestic™**

Majestic™ is a simple, yet elegant style with a smooth top rail, available in 2-rail, 3-rail and 4-rail designs. It is ideally suited for public pools and play areas.

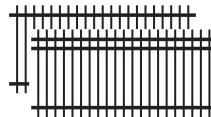

GENESIS

Style G2 (2-Rail - 3', 3½', 4', 4½', 5' & 6')  
Style G3 (3-Rail - 3', 3½', 4', 4½', 5', 6', 7' & 8')  
Style G4 (4-Rail - 7' & 8')

**Genesis™**

The Genesis name was coined for this panel design because it acts as a foundation for creation of multiple custom looks by the addition of decorative Triad or Quad-Flare finials. The Genesis™ style is base for adding decorative finials (see Adornments on Page 8).

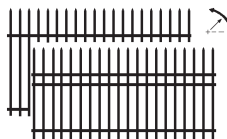

INVINCIBLE®

Style I3 (3-Rail - 7' & 8')  
Style I4 (4-Rail - 7' & 8')

**Invincible™**

Invincible means 'incapable of being overcome'. The gradual outward curve of the pickets makes this style a superior alternative to the chain link and barbed wire fences of the past. 3-rail and 4-rail profiles are available in 7' and 8' heights.

# ECHELON PLUS AND ECHELON II®

The Higher Level of Aluminum Fences

Echelon - A revolutionary fence system of aluminum posts, framework and mounting accessories that is easily assembled to form an attractive "good neighbor" appearance with no exposed fasteners. Any truly great product must have a defining feature that sets it apart from all others; Ameristar's Echelon fence, including Echelon II® Industrial and Echelon Plus® Commercial, has the revolutionary ForeRunner™ rail.

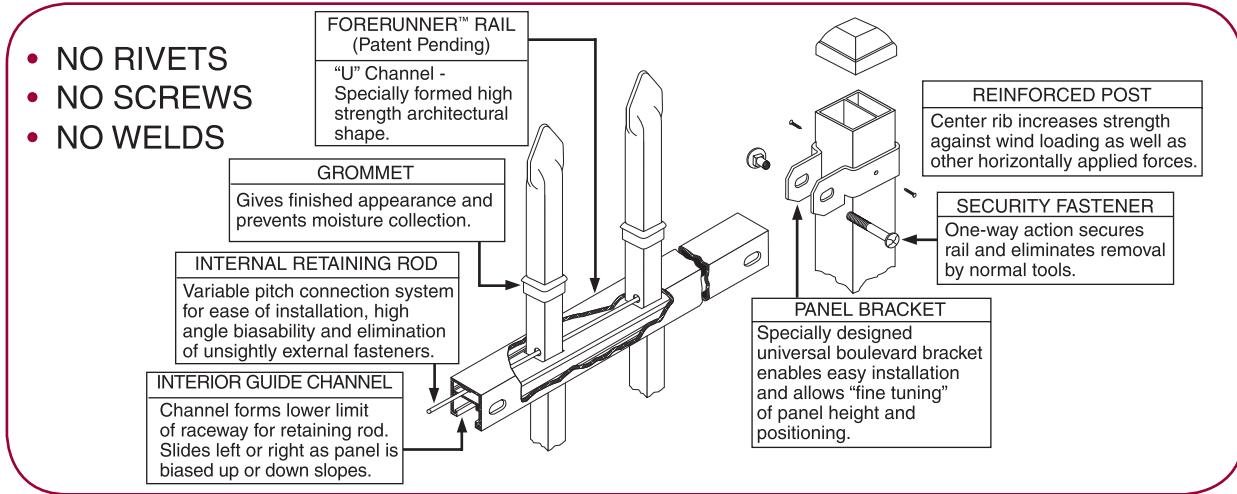

## RAIL STRENGTH

ForeRunner™ (Aluminum) Echelon II®	Structural Parameters	U-Channel (Steel)	U-Channel (Aluminum)
	Profile of the Architectural Shape of the Rail *Vertical Design Loads are per rail; for capacity of fence panel, multiply by number of rails.		
.120/.100	$T_{eff}$ = Effective Wall Thickness (IN)	.120	.100/.070
.2370	$S_v$ = Section Modulus (IN) Vertical	.0938	.1350
.421	$S_h$ = Section Modulus (IN) Horizontal	.210	.260
418#	6' Span	Vertical Load Data	6' Span
314#	8' Span	$PV_u$ = Ultimate Vertical	8' Span
742#	6' Span	Horizontal Load Data	6' Span
556#	8' Span	$PH_u$ = Ultimate Horizontal	8' Span
276#	6' Span	* Vertical Load Data	6' Span
207#	8' Span	$PV_d$ = Vertical Design Load @ .66 $F_y$	8' Span
490#	6' Span	* Horizontal Load Data	6' Span
367#	8' Span	$PH_d$ = Horizontal Design Load @ .66 $F_y$	8' Span

\* RECOMMENDED LOAD VALUE FOR SAFE STRUCTURAL DESIGN (Allowable Strength = .66  $F_y$ ).

## COMPONENT SIZES

System	Pickets	Rails
Echelon II® Industrial	1" x 1"	1-3/4" x 1-3/4"
Echelon Plus® Commercial	3/4" x .050"	1" x 1-1/2"

## COLORS

Request Color Chip samples for actual color



## ADORNMENTS

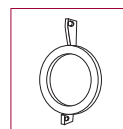
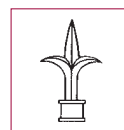
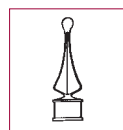



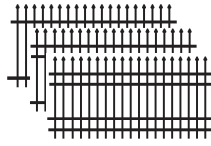

**CLASSIC™**  
Style C2 (2-Rail)  
Style C3 (3-Rail)  
Style C4 (4-Rail)

**Classic™**

Echelon Classic™ style ornamental fences feature the traditional extended picket culminating with an arrow-shaped spear point that conveys a subtle warning message to would-be intruders.

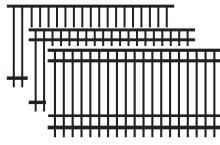

**MAJESTIC™**  
Style M2 (2-Rail)  
Style M3 (3-Rail)  
Style M4 (4-Rail)

**Majestic™**

The contemporary Echelon Majestic™ style utilizes a flush top rail to produce the stately and streamlined look that blends well with flowers, shrubbery, and trees used in border landscapes.

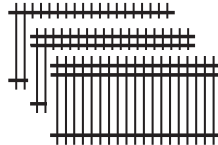

**GENESIS™**  
Style G2 (2-Rail)  
Style G3 (3-Rail)  
Style G4 (4-Rail)

**Genesis™**

The Echelon Genesis™ style highlights the sleek lines of unaltered square pickets reminiscent of solid vertical bar fences. The extended flat-topped tip does not detract from architecture or landscape. The Genesis™ style is base for adding decorative finials.

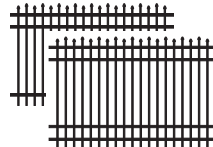

**WARRIOR™**  
Style W3 (3-Rail)  
Style W4 (4-Rail)  
ECHELON PLUS™ ONLY

**Warrior™**

The look of excellence in a traditional ornamental fence is further enhanced by the alternating picket heights that mark the Warrior™ design. This style complements landscaping, giving an elegant look to any property line.

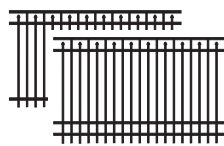

**CONQUEROR™**  
Style R3 (3-Rail)  
Style R4 (4-Rail)  
ECHELON PLUS™ ONLY

**Conqueror™**

The unique Conqueror™ configuration offers ‘the best of both worlds’ by combining the striking look of spear topped pickets with the safety of a flush top rail.

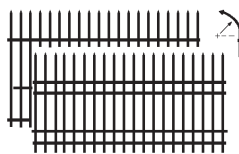

**INVINCIBLE™**  
Style I3 (3-Rail)  
Style I4 (4-Rail)  
ECHELON II® ONLY

**Invincible™**

The imposing Echelon Invincible™ style features an outwardly curving picket to warn potential intruders and make access by climbing virtually impossible.

Echelon Plus® and Echelon II® Industrial Ornamental Aluminum

# TRANSPORT®

## Aluminum Cantilever Gates

U.S.A. Patent No. 5,136,813

TransPort® Cantilever Gate Systems are available for Impasse® Security; Aegis II®, Echelon II® and Estate™ Ornamental; and PermaCoat® and GalvOnAll™ Chain Link applications. The TransPort™ is an all weather cantilever gate and aluminum track extrusion with internal roller assemblies. This results in the gate and track system sliding as a single unit.

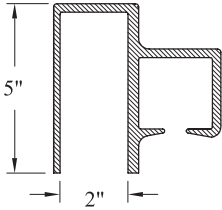



SINGLE FAST-TRAK™ TOP RAIL  
WEIGHT = 5.30 LBS./FT.

### STRENGTH

TransPort® Cantilever Gates offer superior strength as the track is 60% heavier (by weight) than competitor extrusions.



### GATE OPENING SIZES

Gate Type	Opening	Security	Ornamental	Chain Link
  Double Track	Single	6' Through 36'	6' Through 36'	6' Through 36'
	Bi Parting	12' Through 72'	12' Through 72'	12' Through 72'

TransPort® cantilever gates can traverse wide openings without ground support; this means smooth obstruction-free travel. The rollers are enclosed inside Fast-Trak rails ensuring safety and protection from weather.



### TYPES AND STYLES

TransPort® Impasse® Security  
Cantilever Gates

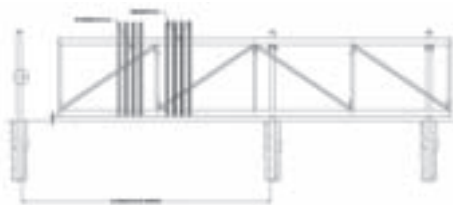

TransPort® Aegis II® and Echelon II®  
Ornamental Cantilever Gates



TransPort® PermaCoat® and GalvOnAll™  
Chain Link Cantilever Gates



TransPort® Estate™  
Ornamental Cantilever Gates

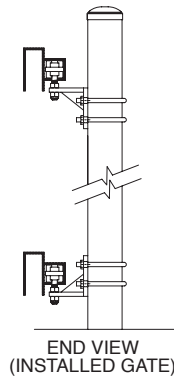

Smooth roll parallels fence



# PASSPORT™

Steel Roll Gates

32 31 00/AME  
BuyLine 5862



PassPort™ roll gates are fabricated with rigidly welded steel frames and are available in heights from 4' to 8' for openings up to 36'. Gates can be made in all the same styles and colors available in Ameristar's ornamental fences.

# ESTATE™

Beautiful, Strong and Maintenance-free Aluminum Entry Gates

The Estate™ design is a statement in itself. It adds value and aesthetics to complete the look of elegance. Private businesses, large estates and condominium complexes are ideal properties for the prestigious appeal of the Estate™ Entry Gate. All framework is 1/4" thick and all intersections are welded. Standard Entry Gates are available either with single leaves for openings up to 14', or with double leaves for openings up to 28'.



Special gates with the same arched top rails can be made in either walk gate or drive gate forms to match the spacings and top designs of all the Ameristar® ornamental fence types (i.e., Aegis II® or Echelon II® Industrial Ornamental, or Aegis Plus®, Montage Plus® or Echelon Plus® Commercial Ornamental) that have straight picket extensions or flush top rails.

## STYLES

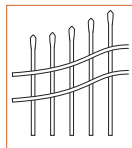

CLASSIC™

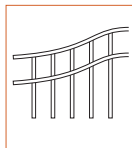

MAJESTIC™

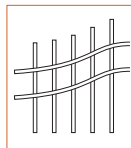

GENESIS™

Warrior™ and Conqueror™ (not shown) are also available.

## ADORNMENTS

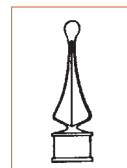

Quad Flare



Triad



Ring



Ball Cap

## COMPONENT SIZES

Pickets	Rails	Uprights
3/4" Square x .125" Wall or 1" Square x .125" Wall	1" x 2" Channel x .250" Wall	2" Square x .250" Wall

## COLORS

Request Color Chip samples for actual color



Black



Bronze



White

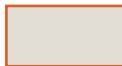

Desert Sand

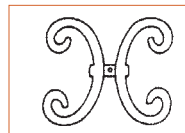

Butterfly



Florentine



Letters

Transport™ Cantilever and PassPort™ Roll Gates





# AMERISTAR®

World's Largest Architectural Metal Fence Manufacturer



Ameristar® was chartered a quarter-century ago to provide specialty fence products that were more affordable, but did not compromise the quality level demanded by specifiers and consumers. This could be accomplished only by complete reformation of the way fence products were being manufactured. Product design was approached from many new perspectives; maximizing high-volume productivity; increasing strength and durability; designing the ultimate level of system security; promoting ease of installation; enhancing aesthetic appearance; and maintaining an environmentally friendly workplace. A new plant was designed and built to house state-of-the-art roll-forming, metal processing and powder coating equipment. The result (see photo above) has boosted Ameristar® to its current position as the largest manufacturer of architectural metal fence systems in the world.



Decades ago, Europe and the Middle East, threatened constantly by terrorism, abandoned chain link fence as a security defense when they found that wire fences could be breached in seconds. The United States felt safe and continued to believe the chain link security myth. We know different now! The first line of perimeter defense must remain impassable to intrusion attempts for several minutes. Using severely sharpened high-strength steel spears, called pales, fastened securely to rigid framework of specially formed rails and posts, Ameristar® has raised the bar of perimeter security with Impasse®.



**AMERISTAR®**  
FENCE PRODUCTS

P.O. BOX 581000 - TULSA, OK. 74158-1000  
(918) 835-0898 - 1-800-321-8724 - FAX (877) 926-3747

email: [mktg@ameristarfence.com](mailto:mktg@ameristarfence.com)

[www.ameristarfence.com](http://www.ameristarfence.com)

see us at  
**Sweets.com**