

# WIREWORKS ANTI-CLIMB

HIGH SECURITY WELDED WIRE ARCHITECTURAL FENCE



## THE STANDARD FOR ANTI-VANDAL FENCING

The WireWorks Anti-Climb system is a unique perimeter security product that maintains a guarded display of visual screening balancing the need to delay and deter an attack. WireWorks Anti-Climb combines a mesh that discourages cutting and climbing with framework that can support a total security platform.

### ANTI-CUT

The welded wire used for WireWorks Anti-Climb is designed to provide a higher level of deterrence through its tightly fabricated design.

### ANTI-CLIMB

The WireWorks Anti-Climb mesh configuration is constructed to supply high levels of delay with a surface that discourages cutting and climbing.

### SECURE

The WireWorks Anti-Climb structure is the same unique design used in Ameristar's anti-ram and high security fencing products. This architecture provides the strongest platform for security integration and system strength offered in the perimeter security industry.

Covered by or for use with one or more of the following U.S. patents: 6.874.767, 7.188.826, 7.651.073



We take great pride in manufacturing "Made in the USA" products. Ameristar is located in Tulsa, Oklahoma and is American owned and operated.

#### Applications:

- Petroleum & Chemical Facilities
- Power Plants & Substations
- Manufacturing Plants
- Military Sites
- Government Facilities
- Airports
- Railway
- Roadways
- Ports of Entry

# WireWorks Anti-Climb

## High Security Welded Wire Architectural Fence

### STRUCTURE

The architecture of WireWorks Anti-Climb integrates a high security mesh into a framework that is unparalleled in strength and application.

#### I-beam

Posts - 3" x 2-3/4" x 12ga.

#### Platform

Rails - 2" x 2" x 11ga.

#### Anti-Climb

Mesh - 3" x 1/2" x 10.5 Ga.

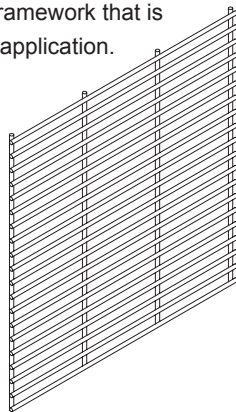

### CONSTRUCTION

The WireWorks Anti-Climb framework and mesh attachments are constructed using retainer brackets and security fasteners. Each of these attachments provides ease of installation and a tamper-proof construction that cannot easily be breached.



### GATES

Ameristar understands the importance of balancing perimeter security with the highest quality entry control gates. WireWorks Anti-Climb has a wide variety of Swing, Slide, and Cantilever Gates to match any entry.

### OPTIONS

WireWorks Anti-Climb has the option to be fitted with barb-arm outriggers which can support barbwire or barbed tape obstacles providing heightened visual deterrence.

### INTEGRATION

The WireWorks Anti-Climb rail can be used as a platform for multiple perimeter security elements. The WireWorks Anti-Climb framework is a raceway for wiring, conduits, and/or security cabling required around the perimeter of a project.

This integrated design eliminates the need for costly trenching and boring becoming a value added solution for perimeter security upgrades.

Use WireWorks Anti-Climb as a platform:



Communication & Video cables  
Intrusion Detection / Fiber Optic Cables  
Access Control Wiring  
Conduits  
Anti-ram Cabling (Stalwart)

### COATING

WireWorks Anti-Climb is protected with Ameristar's unique PermaCoat multi-layer coating process. The combination of these layers delivers a system that increases weathering resistance and product durability.

### WARRANTY

WireWorks Anti-Climb is manufactured using the highest quality materials and is backed with Ameristar's 10 year warranty.



# WIREWORKS ANTI-CLIMB

## WELDED WIRE MESH FENCE & GATE SYSTEM FOR HIGH SECURITY APPLICATIONS

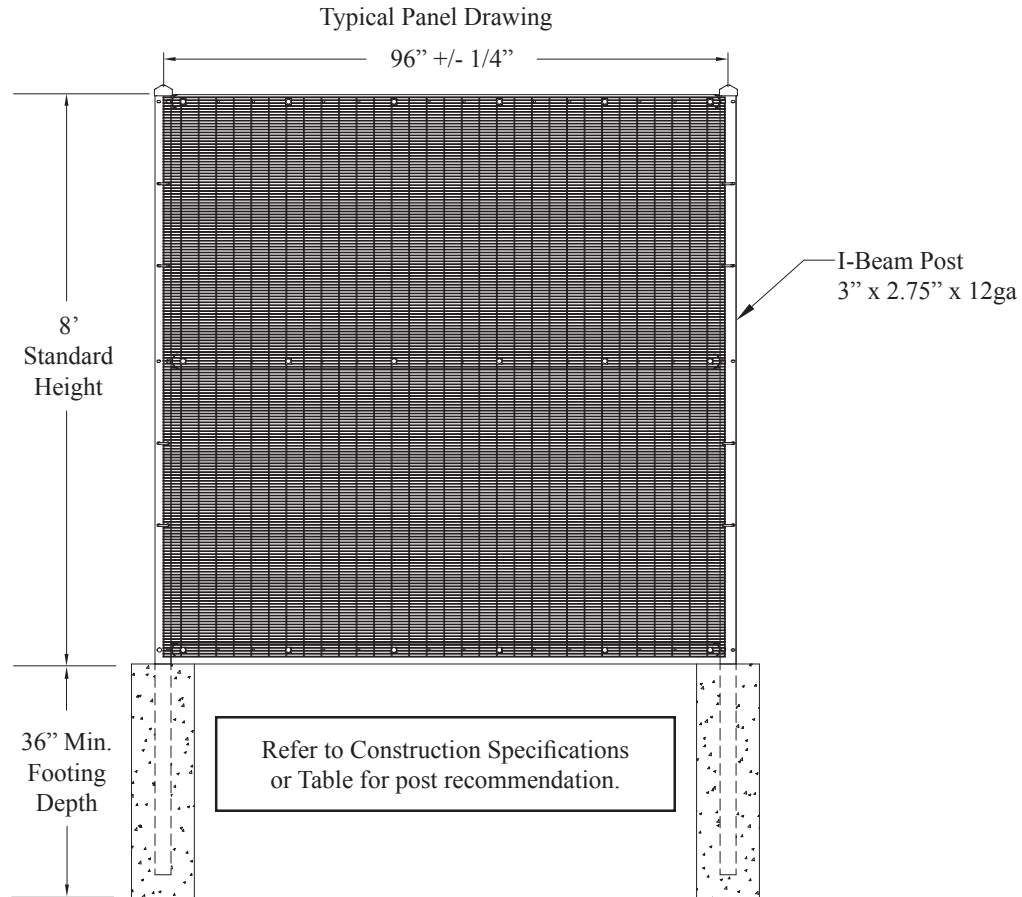

### Security Integration Platform

The unique I-Post and C-Rail that compose the WireWorks Anti-Climb bracketless framework provide an ideal platform for internal routing and integration of multiple security systems including electrical conduit, intrusion detection sensors (IDS), closed-circuit television cable (CCTV), access control wiring, and anti-ram cabling.

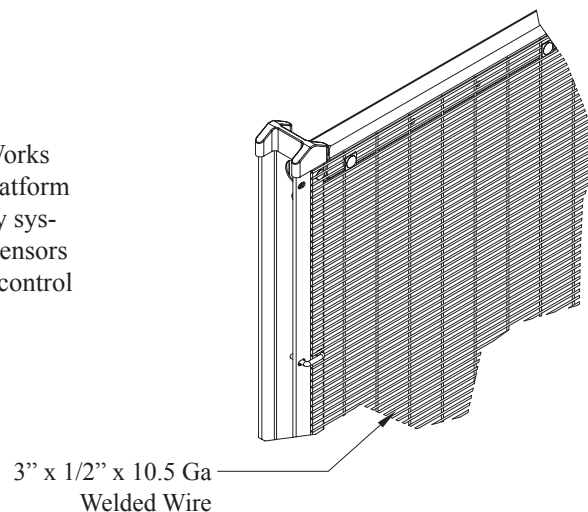

Effective: 04/16/13

WIREWORKS ANTI-CLIMB



1-888-333-3422  
FAX: 1-877-926-3747

WELDED WIRE MESH PANEL KIT

Panel Height	Panel Width	Rail Quantity	Item Number	Catalog Price (Black)	Catalog Price (Color)	Kit Weight
8'	8'	3 Rail Panel	M <u>X</u> 88PK			107 lbs

MX88PK kit contains:

- 1 Ea. 8' x 8' Welded Wire Mesh (5WAB0808)
- 3 Ea. 8' Rails (3BR95)
- 18 Ea. Carriage Bolts 5/16" x 1"
- 18 Ea. Security Nuts 5/16" (B77484)
- 18 Ea. Square Retainers 5/16" (HB621)

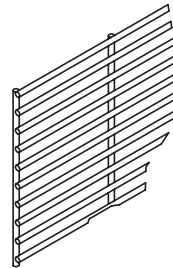

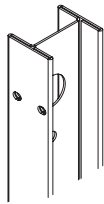

3" x 1/2" x 10.5ga  
Welded Wire  
Architectural Mesh

I-BEAM POSTS

Item Description	Item Number	Catalog Price (Black)	Catalog Price (Color)	Post Weight
	3P <u>X</u> 3132W-3			50 lbs
I-Beam 3" x 2.75" x 12 Ga. Supplied with cast aluminum cap.				

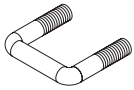
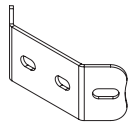
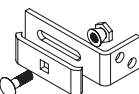
BRACKET KITS

Item Description	Box Quantity	Item Number	Catalog Price (Black)	Catalog Price (Color)	Kit Weight
Line/End Post I-Beam Kit 	10 sets	M <u>X</u> 88L			2 lbs
4 Ea. U-bolts 5/16" (BB608)   6 Ea. Carriage Bolts 5/16" x 1" 14 Ea. Security Nuts 5/16" (B77484)					
Corner Post I-Beam Kit 	4 sets	M <u>X</u> 88C			5 lbs
7 Ea. Corner Bracket (BB607)   28 Ea. Carriage Bolts 5/16" x 1" 28 Ea. Security Nuts 5/16" (B77484)   8 Ea. Square Retainers 5/16" (HB621)					
Gate Post to Mesh Bracket 	50 Sets	W <u>X</u> GB			.9 lbs
Note: For securing mesh to gate post between rails. 4 per post is recommended					
Gate Post to Rail Bracket Kit 	25 sets	B <u>X</u> 602E			.5 lbs
1 Ea. Universal Bracket   2 Ea. 1/2-13 x 1" Carriage Bolts   2 Ea. 1/2-13 Security Nuts Note: Gate post to rail attachment requires use of gate post to mesh bracket fastener set.					

Item Number Colors: replace the X with the appropriate color indicator  
**B** = Black, **N** = Bronze, **S** = Sand, **G** = Green, **TB** = Tube Brown

Effective: 04/16/13







WIREWORKS ANTI-CLIMB



1-888-333-3422

FAX: 1-877-926-3747

CUSTOM FINISHES

ITEM DESCRIPTION	BLACK		COLOR			WEIGHT EACH	
	BLACK PART NO.	DEALER PRICE	BRONZE PART NO.	DESERT SAND PART NO.	DEALER PRICE		
<b>Paint Pen</b> 	PB100		PN100	PS100		.5	
	Custom finishes in the four standard WireWorks Anti-Climb Fence colors. Green & Brown Paint Pens not available.						
<b>Zinc-Rich Paint Pen</b> 	PZ100					.5	
	Priming required for cut steel edges prior to application of Ameristar Custom Finishes. <b>NOTE: All cut wires must be seal coated with Zinc Rich Primer and Ameristar's custom touch-up paint or the warranty is void.</b>						
ITEM DESCRIPTION	BLACK		COLOR				WEIGHT EACH
	BLACK PART NO.	DEALER PRICE	BRONZE PART NO.	DESERT SAND PART NO.	GREEN PART NO.	BROWN PART NO.	
<b>Spray Paint</b> 	FB100		FN100	FS100	FG-100F	FN-100F	1.1
	Custom finishes in standard WireWorks Anti-Climb Fence colors.						
<b>Zinc-Rich Primer</b> 	FZ100					1.1	
	Ideal for priming cut steel edges of panels or components prior to applying the appropriate custom finish color. <b>NOTE: All cut wires must be seal coated with Zinc-Rich Primer and Custom Touch-up Finish or warranty is considered null and void.</b>						

FASTENERS AND ACCESSORIES

ITEM DESCRIPTION	Bag Quantity	Item Number	Catalog Price (Black)	Catalog Price (Color)	Weight
Welded wire mesh to framework fastener sets	6 sets	M X 88F			1 lbs
	MX88F kit contains: 6 Ea. Carriage Bolts 5/16" x 1" 6 Ea. Security Nuts 5/16" (B77484) 6 Ea. Square Retainers 5/16" (HB621)				
Gate Post to Mesh Bracket Fastener Set	1 set	3GPBB3			.6 lbs
	1 set	3GPBB4			.6 lbs
	1 set	3GPBB6			.8 lbs
Note: Used with gate post to rail bracket (BB602E)	3GPBB3 for 3" gate posts   3GPBB4 for 4" gate posts   3GPBB6 for 6" gate posts				

Effective: 04/16/13

## WireWorks® Anti-Climb - High Security Welded Wire Architectural Fence System Construction Specification - SECTION 32 31 00

### PART 1 - GENERAL

#### 1.01 WORK INCLUDED

The contractor shall provide all labor, materials and appurtenances necessary for installation of the Ameristar® WireWorks Anti-Climb® design system defined herein at (specify project site).

#### 1.02 RELATED WORK

Section \_\_\_\_\_ - Earthwork Section \_\_\_\_\_ - Concrete

#### 1.03 SYSTEM DESCRIPTION

The manufacturer shall supply a total commercial welded wire architectural fence system of the Ameristar® WireWorks Anti-Climb® design. The system shall include all components (i.e., panels, brackets, posts, gates and hardware) required.

#### 1.04 QUALITY ASSURANCE

The contractor shall provide laborers and supervisors who are thoroughly familiar with the type of construction involved and materials and techniques specified.

#### 1.05 REFERENCES

ASTM A653/A653M - Standard Specification for Steel Sheet, Zinc-Coated (Galvanized) or Zinc-Iron Alloy Coated (Galvannealed) by the Hot-Dip Process. ASTM B117 - Practice for Operating Salt-Spray (Fog) Apparatus. ASTM D523 - Test Method for Specular Gloss. ASTM D714 - Test Method for Evaluating Degree of Blistering in Paint. ASTM D822 - Practice for Conducting Tests on Paint and Related Coatings and Materials using Filtered Open-Flame Carbon-Arc Light and Water Exposure Apparatus. ASTM D1654 - Test Method for Evaluation of Painted or Coated Specimens Subjected to Corrosive Environments. ASTM D2244 - Test Method for Calculation of Color Differences from Instrumentally Measured Color Coordinates. ASTM D2794 - Test Method for Resistance of Organic Coatings to the Effects of Rapid Deformation (Impact). ASTM D3359 - Test Method for Measuring Adhesion by Tape Test. ASTM F2453/F 2453M - Standard Specification for Welded Wire Mesh Fence Fabric

#### 1.06 SUBMITTAL

The manufacturer's submittal package shall be provided prior to installation.

#### 1.07 PRODUCT HANDLING AND STORAGE

Upon receipt at the job site, all materials shall be checked to ensure that no damages occurred during shipping or handling. Materials shall be stored in such a manner to ensure proper ventilation and drainage, and to protect against damage, weather, vandalism and theft.

### PART 2 - MATERIALS

#### 2.01 MANUFACTURER

The fence system shall conform to Ameristar® WireWorks Anti-Climb® design by Ameristar Fence Products, Inc. in Tulsa, Oklahoma.

#### 2.02 MATERIAL

A. Steel material for fence posts and rails shall be galvanized prior to forming in accordance with the requirements of ASTM A653/A653M, with minimum yield strength of 45,000 psi (310 MPa). The steel shall be hot-dip galvanized to meet the requirements of ASTM A653/A653M with a minimum zinc coating weight of 0.90 oz/ft<sup>2</sup>, Coating Designation G-90. Fence posts and gate posts shall meet the minimum size requirements of Table 1.

B. Steel wire mesh fence panels shall be welded by resistance welding per ASTM A185 using pre-galvanized steel wire, welded at each crossing to form rectangles. Vertical 10.5ga. (0.128 inches) wires shall be spaced at 3 inches; horizontal 10.5ga. (0.128 inches) wires shall be spaced at .5 inches. The cold rolled wire shall have a tensile strength of at least 74,000 psi and 68,000 psi shear strength. Wire strand shall be galvanized before welded (GBW), .050 ounces per square foot zinc coating conforming to the ASTM A641.

C. The cross-sectional shape of the rails shall conform to the manufacturer's Impasse II™ C-rail design, a nominal 2" x 2" x 11 Ga. Tamperproof fasteners shall be used to fasten each wire mesh retaining bracket to rail at intervals not exceeding 18 inches. Posts shall conform to the manufacturer's Impasse II™ I-Beam design with a nominal 3" x 2.75" x 12 Ga.

### 2.03 FABRICATION

A. Wire mesh panels and posts shall be pre-cut to specified lengths. Panel width shall be no greater than 96" wide.

B. The manufactured fence system (i.e., panels, brackets, posts, gates and hardware) shall be subjected to the PermaCoat® thermal stratification coating process (high-temperature, in-line, multi-stage, multi-layer) including, as a minimum, a six-stage pretreatment/wash (with zinc phosphate), an electrostatic spray application of an epoxy base, and a separate electrostatic spray application of a polyester finish. The base coat shall be a thermosetting epoxy powder coating (gray in color) with a minimum thickness of 2 mils (0.0508mm). The topcoat shall be a "no-mar" TGIC polyester powder coat finish with a minimum thickness of 2 mils (0.0508mm). The color shall be (specify Black, Bronze, White, Desert Sand, Green, or Brown). The stratification-coated framework shall be capable of meeting the performance requirements for each quality characteristic shown in Table 2.

C. Swing gates shall be fabricated using 2" square rails and gate ends. Gates that exceed 6' in width will have a 2" square intermediate upright. All rail and upright intersections shall be joined by welding. All rail, upright, and gate end intersections shall also be joined by welding. Steel gussets (1/4" x 2") shall be welded at each rail to gate end and rail to intermediate intersections. Gusset shall be punched to accept gate trussing cable and turnbuckle.

### PART 3 - EXECUTION

#### 3.01 PREPARATION

All new installation shall be laid out by the contractor in accordance with the construction plans.

#### 3.02 FENCE INSTALLATION

Fence post shall be spaced according to Table 3, plus or minus 1/4". For installations that must be raked to follow sloping grades, the post spacing dimension must be measured along the grade. Fence panels shall be attached to the line and end posts with fasteners supplied by the manufacturer. Attachment to corner post shall be made using brackets and fasteners supplied by the manufacturer (See Figure 1). Posts shall be set in concrete footers having a minimum depth of 36" (Note: In some cases, local restrictions of freezing weather conditions may require a greater depth). The "Earthwork" and "Concrete" sections of this specification shall govern material requirements for the concrete footer. Posts setting by other methods such as plated posts or grouted core-drilled footers are permissible only if shown by engineering analysis to be sufficient in strength for the intended application.

#### 3.03 FENCE INSTALLATION MAINTENANCE

When cutting/drilling rails or posts adhere to the following steps to seal the exposed steel surfaces; 1) Remove all metal shavings from cut area. 2) Apply zinc-rich primer to thoroughly cover cut edge and/or drilled hole; let dry. 3) Apply 2 coats of custom finish paint matching fence color. Failure to seal exposed surfaces per steps 1-3 above will negate warranty. Ameristar spray cans or paint pens shall be used to prime and finish exposed surfaces; it is recommended that paint pens be used to prevent overspray. Use of non-Ameristar parts or components will negate the manufacturer's warranty.

#### 3.04 GATE INSTALLATION

Gate posts shall be spaced according to the manufacturer's gate drawings, dependent on standard out-to-out gate leaf dimensions and gate hardware selected. Type and quantity of gate hinges shall be based on the application; weight, height, and number of gate cycles. The manufacturer's gate drawings shall identify the necessary gate hardware required for the application. Gate hardware shall be provided by the manufacturer of the gate and shall be installed per manufacturer's recommendations.

#### 3.05 CLEANING

The contractor shall clean the jobsite of excess materials; post-hole excavations shall be scattered uniformly away from posts.

(Note: See following pages for Table 1, 2, & 3)

Effective: 04/16/13

WireWorks Anti-Climb - Specification Continued

TABLE 1 - MINIMUM SIZES FOR WIREWORKS ANTI-CLIMB POSTS

FENCE POST RECOMMENDATION CHART	
FENCE POSTS	PANEL HEIGHT
3" X 2.75" X 12 GA.	8' HIGH

GATE POST RECOMMENDATION CHART	
GATE LEAF	GATE HEIGHT
UP TO 4'	3" X 12GA.
4'1" TO 6'	3" X 12GA.
6'1" TO 10'	6" X 3/16"
10'1" TO 16'	6" X 3/16"

TABLE 2 - COATING PERFORMANCE REQUIREMENTS

Quality Characteristics	ASTM Test Method	Performance Requirements
Adhesion	D3359 – Method B	Adhesion (Retention of Coating) over 90% of test area (Tape and knife test).
Corrosion Resistance	B117, D714 & D1654	Corrosion Resistance over 1,000 hours (Scribed per D1654; failure mode is accumulation of 1/8" coating loss from scribe or medium #8 blisters).
Impact Resistance	D2794	Impact Resistance over 60 inch lb. (Forward impact using 0.625" ball).
Weathering Resistance	D822 D2244, D523 (60° Method)	Weathering Resistance over 1,000 hours (Failure mode is 60% loss of gloss or color variance of more than 3 delta-E color units).

TABLE 3 - WIREWORKS ANTI-CLIMB POST SPACING

SPAN	WIREWORKS ANTI-CLIMB
POST SIZE	3" x 2.75" x 12 Ga. I-beam
POST SETTINGS +/- 1/8" O.C.	96"

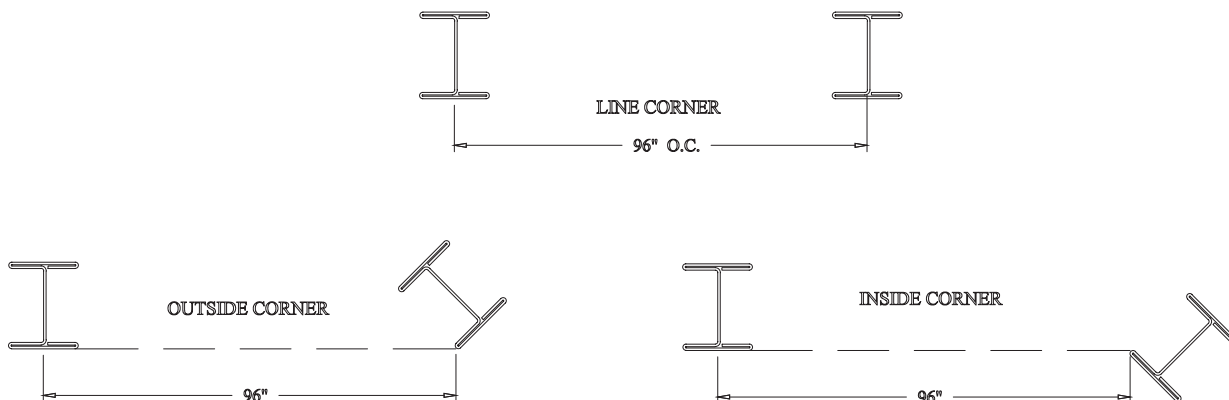

Effective: 04/16/13

## WIREWORKS ANTI-CLIMB® HIGH SECURITY 10 YEAR LIMITED WARRANTY

WireWorks Anti-Climb® High Security Welded Wire Architectural Fence System by AMERISTAR is manufactured from the highest quality materials by skilled craftsmen to meet the highest standards of workmanship in the industry. Galvanized steel framework shall be subjected to a six stage pretreatment/wash (with zinc phosphate) followed by an electrostatic spray application of the PermaCoat Color System, a two coat powder system. The base coat is a thermosetting epoxy powder coating (gray in color). The topcoat is a “no-mar” TGIC polyester powder coat finish, which provides the protection necessary to withstand adverse environmental conditions.

The powder coated surface on all framework (i.e., panels, posts and brackets) by AMERISTAR® is guaranteed under normal and proper usage, against cracking, peeling, chipping, blistering or corroding for a period often (10) years from the original purchase date. Normal and proper usage does not include physical damage, abrasion or exposure to salty environments to the protective coating.

WireWorks Anti-Climb® High Security Welded Wire Architectural Fence System framework is also guaranteed for the same period of time against defects in workmanship or materials.

Should any architectural fence framework manufactured by Ameristar® Fence Products fail in accordance with any of the above conditions, Ameristar® Fence Products warrants to the original purchaser their redemption through replacement, renewal or issuance of a pro-rated credit. The decision as to which method of redemption is allowed is solely at the discretion of Ameristar®. If pro-rated allowance is the chosen alternative, the amount will be based on the total number of years under warranty from date of purchase to date of claim, based on the original cost of framing materials found to be defective. Notice of failure under the conditions of this warranty shall be sent to Ameristar® Fence Products or its authorized representative, in writing, together with proof of purchase and shall specify the nature of the defect and when it was first observed. When cutting WireWorks Anti-Climb products immediately seal the exposed surfaces by **1) Removing all metal shavings from cut area** **2) Apply zinc-rich primer to thoroughly cover cut edge and drilled hole; let dry** **3) Apply 2 coats of custom finish spray paint matching fence color.** Failure to seal exposed surfaces per steps 1-3 above will negate warranty. If contractor uses non Ameristar parts/components this will negate the warranty. Should the fence be improperly installed, Ameristar® Fence Products shall not be responsible for guaranteed performance or appearance of the material. Neither does this guarantee apply when failure or damage is due to improper use or application, abuse or misuse, salty environments, vandalism or acts of God. Ameristar® Fence Products reserves the right to inspect the material to determine validity of the claim.

Upon validation of the claim by Ameristar® Fence Products or its authorized representative, redemption by replacement, renewal or issuance of a pro-rated credit shall be made by Ameristar® Fence Products. Reimbursement for the costs of removal and installation of materials are not included in the guarantee, nor will Ameristar® Fence Products provide those services.

The above constitutes the complete warranty by the manufacturer. No other agreement, written or implied, is valid. Ameristar® Fence Products does not authorize any other person or agent to make any other express warranties. Ameristar® Fence Products neither assumes nor authorizes any other person or agent to assume any other liability in connection with WireWorks Anti-Climb® High Security Welded Wire Architectural Fence System. Some jurisdictions do not allow limitations on how long an implied warranty lasts, nor do they allow an exclusion or limitation of incidental or consequential damages; therefore, the limitations and exclusions noted herein may not apply.

PURCHASE DATE \_\_\_\_\_

DEALER SIGNATURE \_\_\_\_\_



P. O. BOX 581000 TULSA, OKLAHOMA 74158-1000



WIREWORKS ANTI-CLIMB



1-888-333-3422

FAX: 1-877-926-3747

### GATE SPECIFICATION

- Gate Ends 2" Square Steel
- Rails 2" Square Steel
- Welded Wire 3" x 1/2" x 10.5 Ga. Steel

All gate frame and wire-to-rail intersections are securely welded.

Note: All gate leaves greater than 6 feet in width will have an intermediate center upright and trussing cable with turnbuckle.  
Wire Mesh to match corresponding panel height.

### GATE DRAWING DIMENSIONAL FORMAT

Typical Panel Drawing (8' Height Shown)

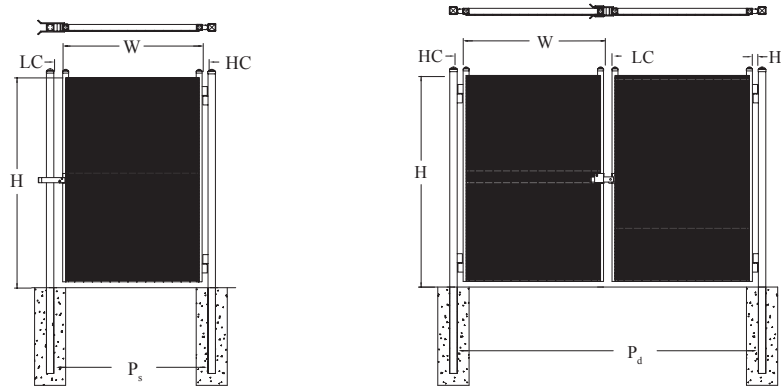

W = Outside To Outside Width of Finished Gate Leaf

H = Height; HC = Hinge Clearance; LC = Latch Clearance; P<sub>s</sub> = Post Interspace (Single); P<sub>d</sub> = Post Interspace (Double)

Hardware Kits and Posts Interspaces for WireWorks Anti-Climb <u>Single Swing Gates</u>														
W=Leaf Width	3.5'	4'	5'	6'	7'	8'	9'	10'	11'	12'	13'	14'	15'	16'
180 Hinge & Strong Arm Latch Kit #HGBS-25 or #HGBS-3	HC	1-5/8"												
	LC	3"												
	P <sub>s</sub>	46-5/8"	52-5/8"	64-5/8"	76-5/8"	88-5/8"	100-5/8"	112-5/8"	124-5/8"	136-5/8"	148-5/8"	160-5/8"	172-5/8"	184-5/8"
Box Hinge & Fork Latch Kit #IGBSX25 or #IGBSX3	HC	2"												
	LC	2"												
	P <sub>s</sub>	46"	52"	64"	76"	88"	100"	112"	124"	136"	148"	160"	172"	184"
P <sub>s</sub> (Post Interspace for Single Gate) = HC (Hinge Clearance) + W (Gate Width) + LC (Latch Clearance)														
Note: Single vertical wire may need to be cut in order to effectively install hinges and latch														

Hardware Kits and Posts Interspaces for WireWorks Anti-Climb <u>Double Swing Gates</u>														
180 Hinge & Strong Arm Latch Kit #HGBD	HC	1-5/8" x 2												
	LC	3"												
	P <sub>d</sub>	90-1/4"	102-1/4"	126-1/4"	150-5/8"	174-1/4"	198-1/4"	222-1/4"	246-1/4"	270-1/4"	294-1/4"	318-1/4"	342-1/4"	366-1/4"
Box Hinge & Fork Latch Kit #IGBDX	HC	2" x 2												
	LC	2"												
	P <sub>d</sub>	90"	102"	126"	150"	174"	198"	222"	246"	270"	294"	318"	342"	366"
P <sub>d</sub> (Post Interspace for Double Gate) = 2 x HC (Hinge Clearance) + 2 x W (Gate Width) + LC (Latch Clearance)														
Note: Single vertical wire may need to be cut in order to effectively install hinges and latch														

Note: See Sales Policy for additional information pertaining to gate orders.

Effective: 04/16/13

ANTI-CLIMB WELDED WIRE MESH GATES

Typical Panel Drawing

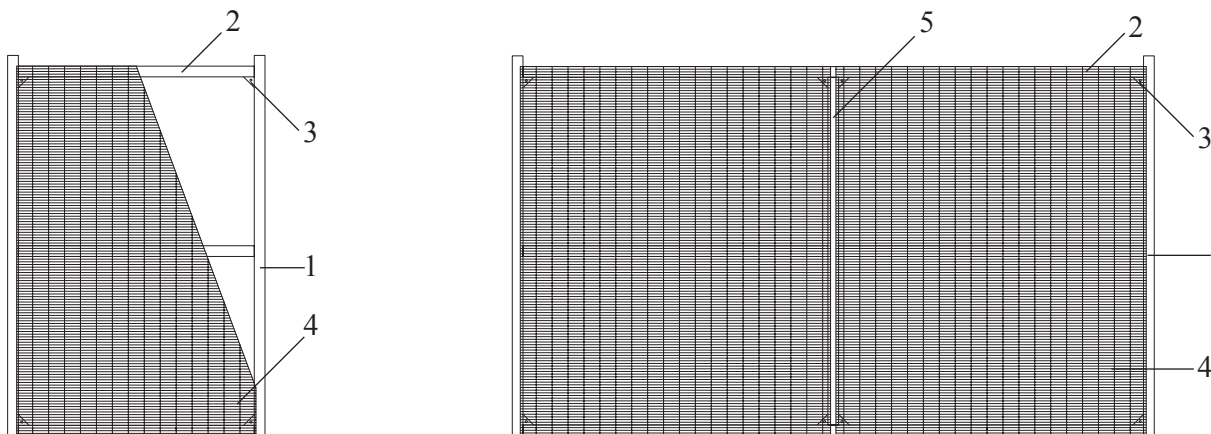

- 1. Gate end - 2" Square Steel
- 2. Rail - 2" Square Steel
- 3. Gussets - 1/4" x 2.5"
- 4. Wire mesh is welded to frame at max. 18" intervals
- 5. Upright - 2" Square Steel

Note: All gate leaves greater than 6 feet in width will have an intermediate center upright and trussing cable with turnbuckle.  
Wire Mesh to match corresponding panel height.

Gate Height	Gate Leaf	Item Number	Catalog Price (Black)	Catalog Price (Color)	Gate Weight
8'	3½'	5WA <u>X</u> 08-42			98
	4'	5WA <u>X</u> 08-48			104
	5'	5WA <u>X</u> 08-60			116
	6'	5WA <u>X</u> 08-72			128
	7'	5WA <u>X</u> 08-84			163
	8'	5WA <u>X</u> 08-96			175
	9'	5WA <u>X</u> 08-108			188
	10'	5WA <u>X</u> 08-120			200
	11'	5WA <u>X</u> 08-132			222
	12'	5WA <u>X</u> 08-144			224
	13'	5WA <u>X</u> 08-156			237
	14'	5WA <u>X</u> 08-168			249
	15'	5WA <u>X</u> 08-180			261
16'	5WA <u>X</u> 08-192			273	

- X = COLOR SELECTION
- B = BLACK
- G = GREEN
- N = BRONZE
- S = SAND
- TB = TUBE BROWN
- W = WHITE

Effective: 04/16/13

