

Indoor/Outdoor
Modular Solution
for Commercial
Applications

Vega

WM
series

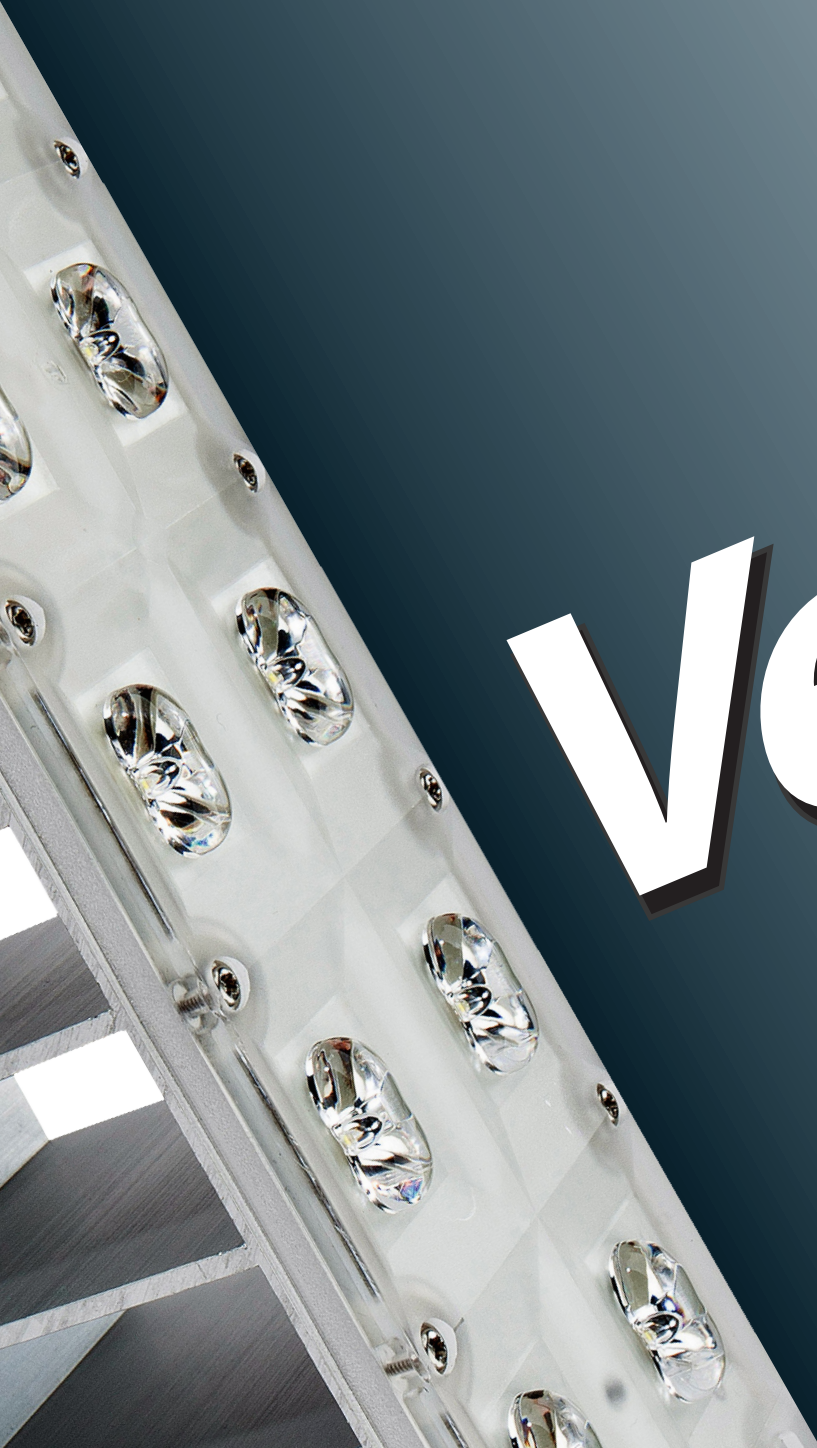

it's multifunctional



The Vega WM is an outstanding performer with a sturdy mounting bracket. Whether it be for wall pack use or mounting to a pole, the WM is perfect for replacing up to 400W MH fixtures. The WM already saves up to 80% energy over traditional lighting. Connect this fixture to a photocell or motion sensor for even greater energy savings.

**Pole or
Wall Mount
Applications**

Applications: Wall pack, area light, architectural, pathways and security lighting.

Vega WM Series Features:

The Vega Modular LED Lens System features a durable and abrasion resistant polycarbonate lens housed within a modular design. With a high color rendering index of 75 or greater, all original colors are realized. Vega fixtures demonstrate first class quality within a beautiful, modern appearance. They are national listing lab tested with LM-79 reports to IESNA standards.

Designed with a purpose, the Vega features unprecedented lighting-class brightness, efficacy, lifetime and quality of light. These lighting-class features enable the XPG LED to replace many traditional light sources and save money with energy-efficient light and long lifetimes. Cree's advantage is in the materials they use. CREE® LEDS combine highly efficient InGaN materials with proprietary G•SIC® substrates to deliver superior price/performance for high-intensity LEDS. Typical features of CREE® LEDS include a single wire-bond connection, low forward voltage, exceptional thinness, low heat generation, high electrostatic discharge (ESD) tolerance/resistance and long life. This, coupled with a high performance power supply and extremely durable housing, puts the Vega at the top of its class.

Conforming to ISO9001:2000 Quality Management System, the Vega Area Light products maintain CE, RoHs, UL and cUL Certifications. Utilizing CREE LEDS, Philips drivers, and a frame built to withstand extreme weather, you will be confident with your purchase for years to come. Start saving up to 80% system energy over your existing HID fixture. Utilize Vega's dimming capabilities for even greater results. The Vega shines bright above the rest.

Housing & Finish:

- Patented modular structure to realize power serialization by changing module quantity
- Aerodynamic styling
- Separable installation method
- Complies with Dark Sky requirements when mounted horizontally to the ground
- Heavy grade die-cast aluminum alloy construction built for extreme weather and durability
- Corrosion resistant polyester powder coat finish with 70-90 micrometer thickness
- Available in standard and custom housing colors
- Easy access power door assembly for quick installation and maintenance
- Open air modular heatsink ventilation design for best possible heat dissipation and optimum efficiency
- High shock and vibration resistance approved - 2G vibration test IEC 60598-1
- Flexible drive allocation options for different regions
- Spaces between modules prevent debris build-up by water-flow self-cleaning



LED & Lens Assembly:

- High efficacy CREE XPG LEDS >85 Lm/W
- Glare reducing optical lens design
- Precise, non-image optics system, improves lumen output ratio with uniform distribution
- Lens reflector built directly over the LEDS for accurate beam angle and photometrics
- Durable and abrasion resistant polycarbonate lens with modular design
- Instant on or off without delay or re-strike
- High CRI - RA>75 enhances original colors
- Contains no Mercury or Lead
- No infrared or UV radiation resulting in insect reduction
- National listing lab tested with LM-79 reports to IESNA standards
- Lumen depreciation is L70 at 60,500 hours



WM Mounting:

- Heavy duty mounting arm for 4" poles or wall mount
- Stainless steel, SAE, heavy gauge adjusting screws
- Available in many different IES lens types
- Dimming and electrical cable included, pre-wired, extended outside the unit for quick installation
- Terminal block and quick wire disconnects pre-wired
- External motion sensor and photocell capable

Certifications & Warranty:

- CE, UL, cUL, suitable for wet locations per UL 1598
- All components are IP66 rated according to IEC60598
- RoHS compliant
- Operating temperature: -40 to 55 C
- Operating humidity: 10% to 95%
- 5 year limited system warranty

Available Models:

- VVDWM014: 19.8" (L) - 16.5 lbs
- VVDWM028: 22.2" (L) - 18.1 lbs
- VVDWM042: 24.6" (L) - 19.8 lbs
- VVDWM056: 27.1" (L) - 21.4 lbs
- VVDWM070: 29.5" (L) - 22.9 lbs
- VVDWM084: 31.9" (L) - 27.0 lbs

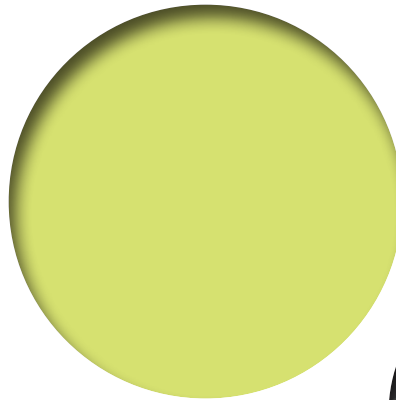
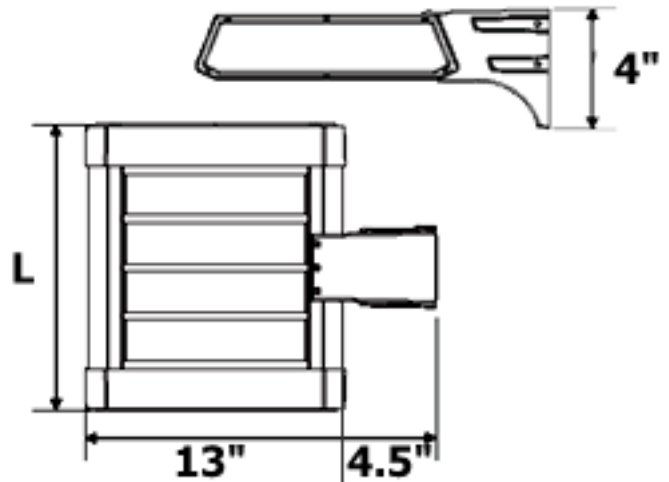
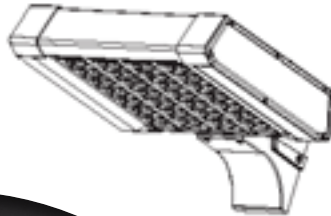

BRACKETS AND MOUNTING ACCESSORIES AVAILABLE. Contact us for a custom quote.

A2M Lens - Asymmetric Type II Medium

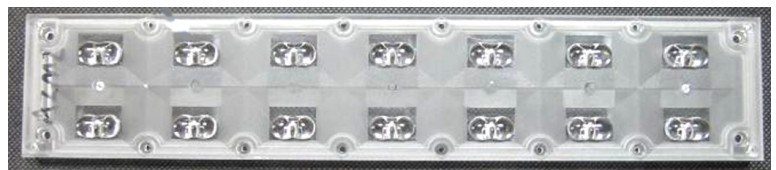
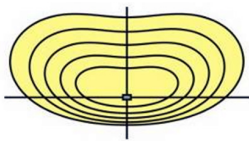
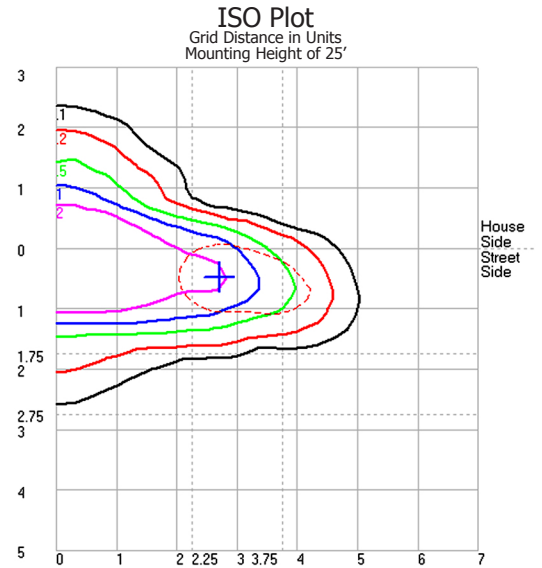
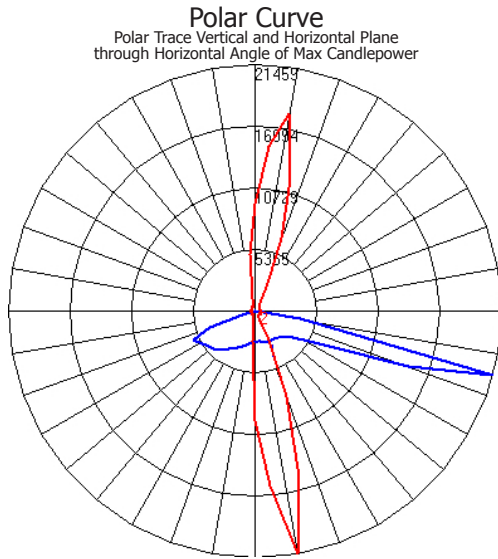
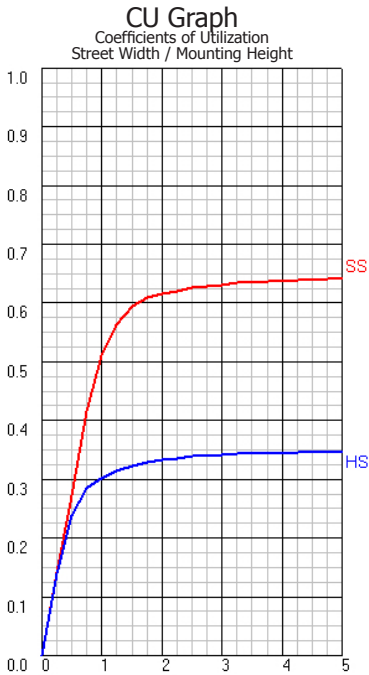

LED POWERED BY:
CREE

The above photometrics are based on Independent Testing Laboratories certified test report # ITL73461. 126 LED streetlight with 20,446 total integrated lumens at 700mA. 4000K candlepower trace and 85 CRI. 120VAC input.

A3L Lens - Asymmetric Type III Long

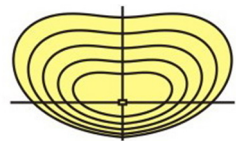
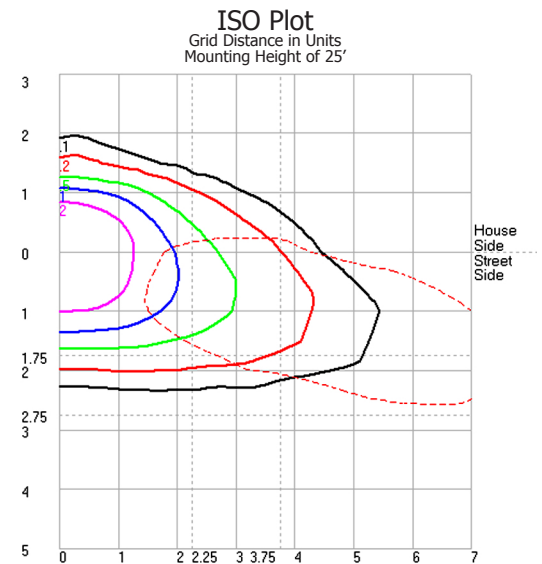
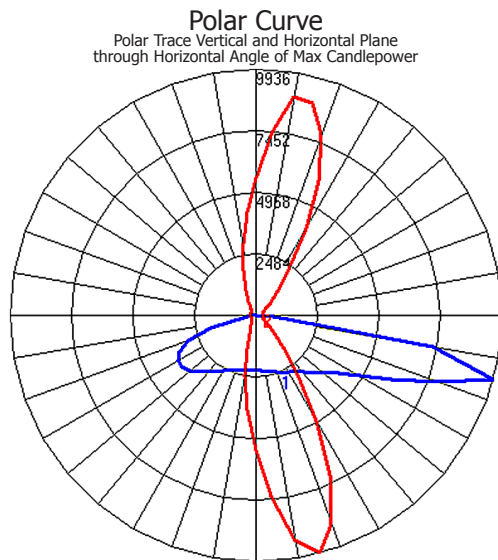
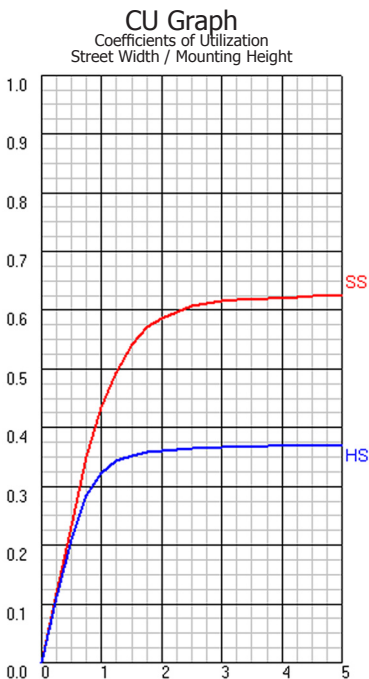

LED POWERED BY:
CREE

The above photometrics are based on Independent Testing Laboratories certified test report # ITL73461. 126 LED streetlight with 20,446 total integrated lumens at 700mA. 4000K candlepower trace and 85 CRI. 120VAC input.

A2MH Lens - Asymmetric Type II Med Horizontal

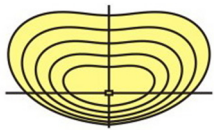
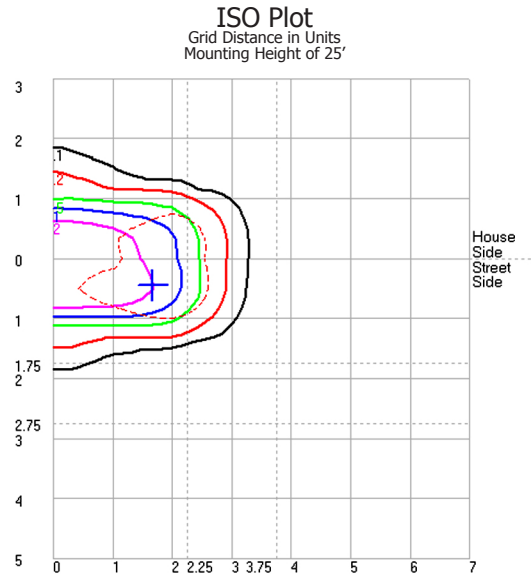
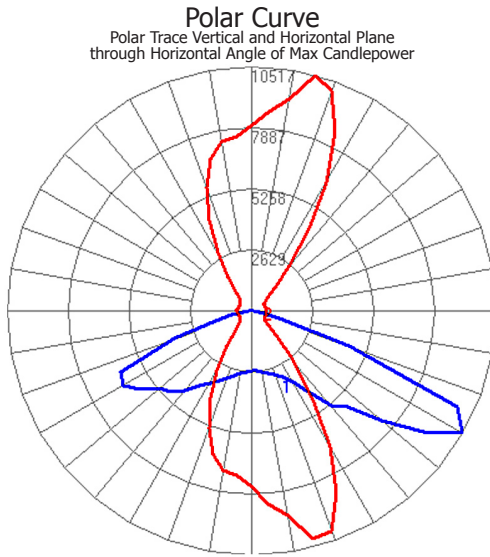
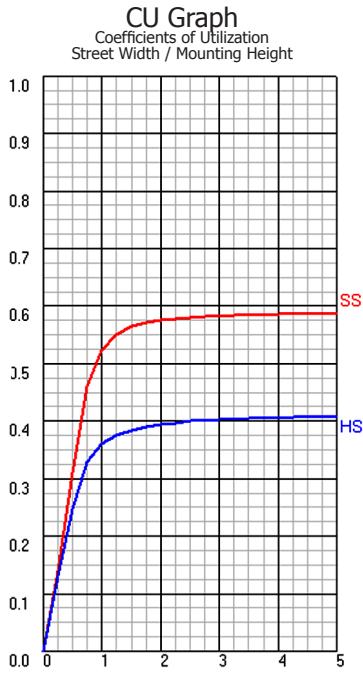

LED POWERED BY:
CREE

The above photometrics are based on Independent Testing Laboratories certified test report # ITL73461. 126 LED streetlight with 20,446 total integrated lumens at 700mA. 4000K candlepower trace and 85 CRI. 120VAC input.

S1S Lens - Symmetric Type I Short

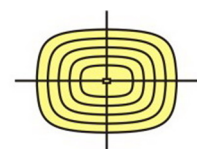
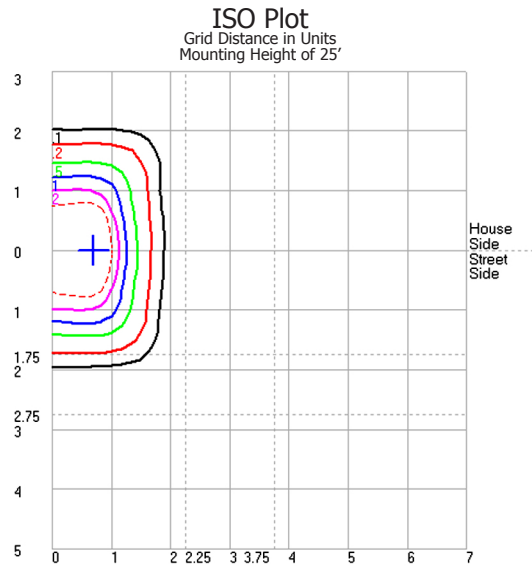
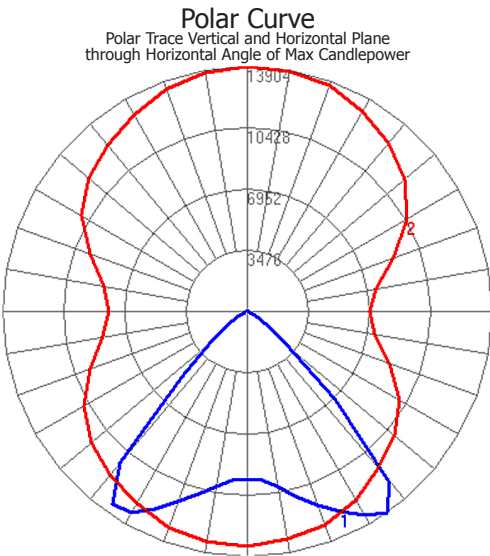
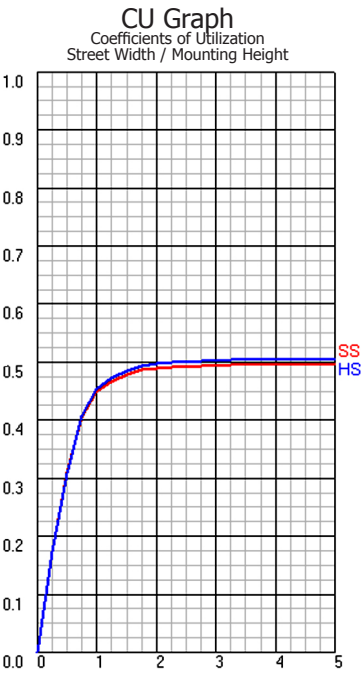

LED POWERED BY:
CREE

The above photometrics are based on Independent Testing Laboratories certified test report # ITL73461. 126 LED streetlight with 20,446 total integrated lumens at 700mA. 4000K candlepower trace and 85 CRI. 120VAC input.

S5M Lens - Symmetric Type V Medium

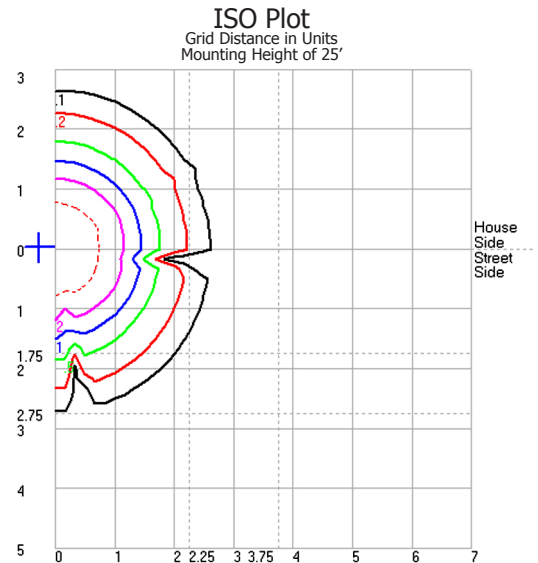
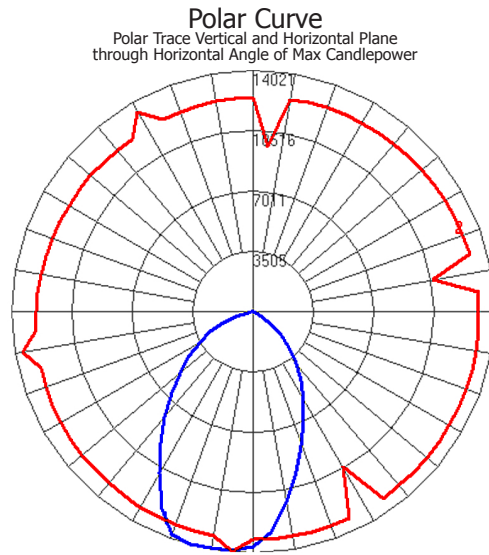
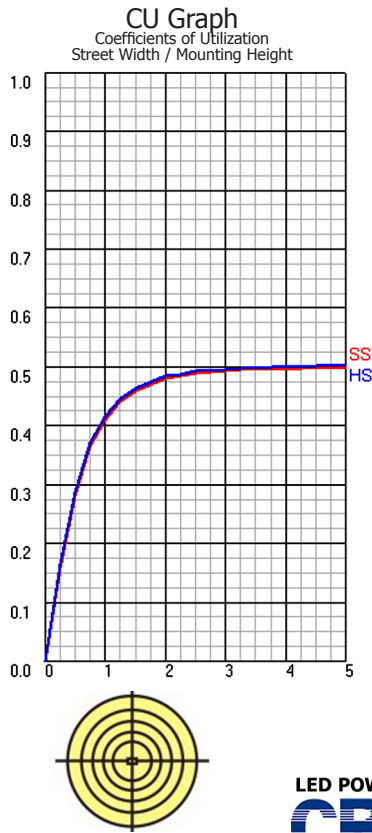

LED POWERED BY:
CREE

The above photometrics are based on Independent Testing Laboratories certified test report # ITL73461. 126 LED streetlight with 20,446 total integrated lumens at 700mA. 4000K candlepower trace and 85 CRI. 120VAC input.

S1SH Lens - Symmetric Type I Short Horizontal

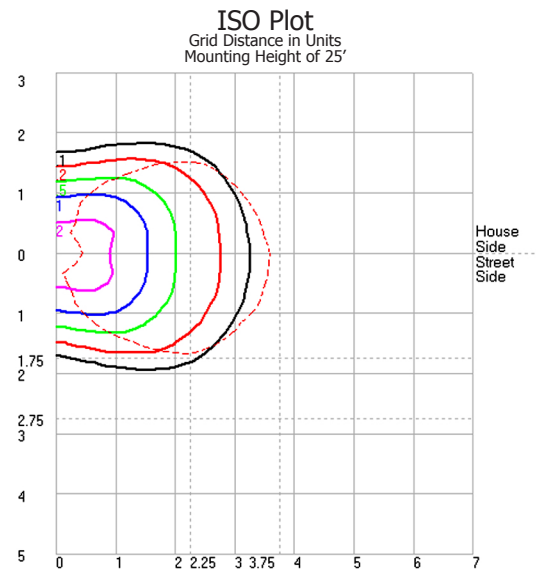
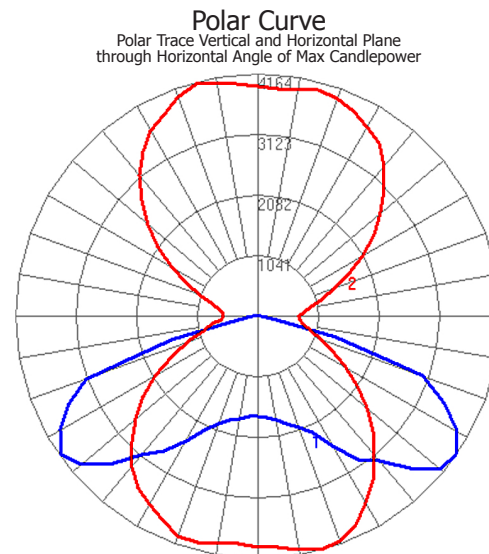
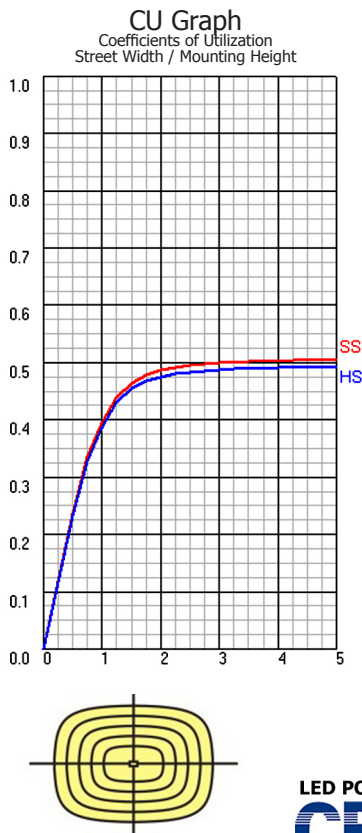

LED POWERED BY:
CREE

The above photometrics are based on Independent Testing Laboratories certified test report # ITL73461. 126 LED streetlight with 20,446 total integrated lumens at 700mA. 4000K candlepower trace and 85 CRI. 120VAC input.

S1M Lens - Symmetric Type I Medium

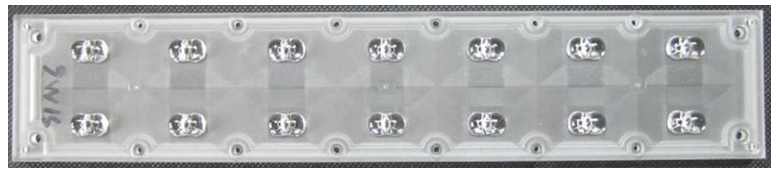
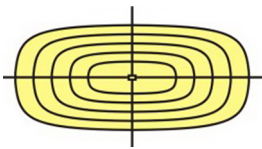
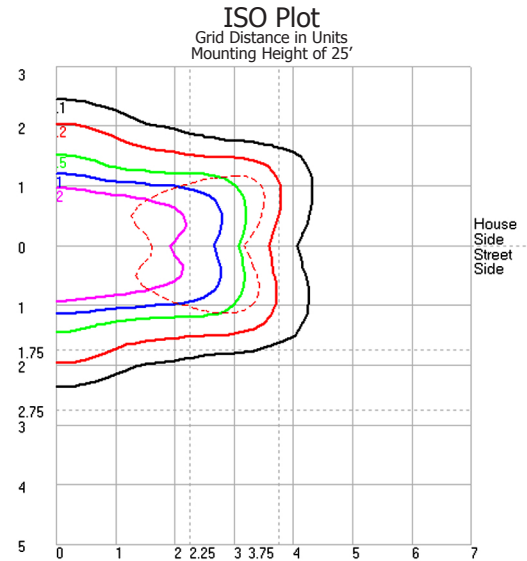
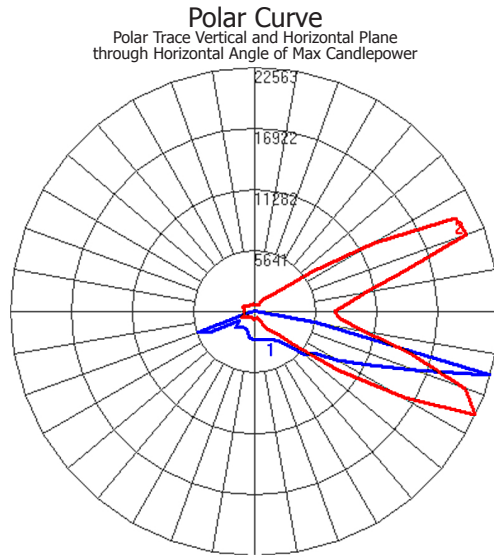
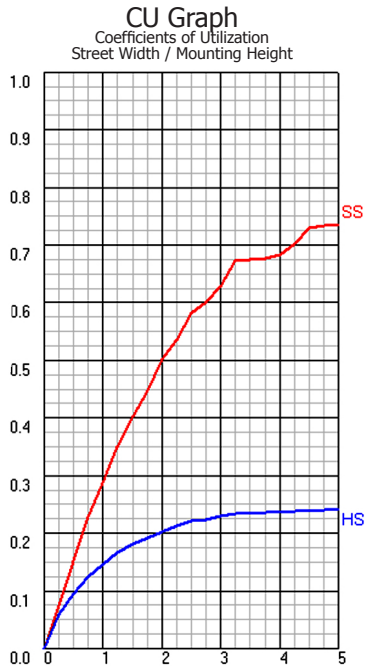

LED POWERED BY:
CREE

The above photometrics are based on Independent Testing Laboratories certified test report # ITL73461. 126 LED streetlight with 20,446 total integrated lumens at 700mA. 4000K candlepower trace and 85 CRI. 120VAC input.

VEGA FAMILY SPECIFICATIONS



# of LEDs	# of Modules	LED Wattage	System Watts 120V	Current (Amps)	Initial Lumens*	Lumens Per Watt	Power Factor	Drive Current	CRI	B	U	G	EPA (SQ. ft)	L70 Hours
14	1	30	33	0.28	2,618	80	0.98	700mA	76	3	0	4	1.17	60,500
28	2	60	67	0.56	5,408	81	0.98	700mA	76	3	0	4	1.31	60,500
42	3	90	96	0.81	8,046	83	0.99	700mA	76	3	0	4	1.45	60,500
56	4	120	129	1.08	10,039	78	0.99	700mA	76	3	0	4	1.59	60,500
70	5	150	164	1.37	12,970	79	0.99	700mA	75	3	0	4	1.72	60,500
84	6	180	191	1.61	15,327	80	0.99	700mA	75	3	0	4	1.86	60,500
98	7	210	224	1.87	17,872	80	0.99	700mA	75	3	0	4	2.01	60,500
112	8	240	250	2.09	20,343	81	0.99	700mA	75	3	0	4	2.21	60,500
126	9	270	286	2.39	22,578	79	0.99	700mA	75	3	0	4	2.34	60,500
140	10	300	315	2.63	25,276	80	0.99	700mA	75	3	0	4	2.48	60,500

*Initial Lumens based on 4700-5300K temperature package. Lumens vary per color temperature selected.



VEGA WM

Modular LED Area Light Fixture

Job Name: _____

Job Type: _____

Due Date: _____

Notes: _____

Before placing an order, we recommend referencing the product data sheet from our website to ensure the most accurate information.

Note: Not all LED configurations and accessories are available for all families of fixtures. Please reference the information found in this datasheet or on our website at www.vividleds.us.



Part Number:

VVDWM - - - - -

Family	# of LEDs	Color Temp	IES Type	Voltage	Finish	Dimming	Drive Current	Accessories
AR	014	W - 2700-3300K	A2M	V27 - 100-277VAC	BK - Black	ND - No-Dim	BLANK - 700mA	BLANK - None
PL	028	N - 3700-4300K	A2MH	V48 - 347-480VAC	SG - Silver Gray	D1 - 0-10V Dim	525 - 525mA	PC - VVD202
SM	042	P - 4700-5300K	A3L	D12 - 12VDC	WT - White	PD - Program Dim (Specify Schedule)	350 - 350mA	SC - VVD208
RM	056	C - 5700-6500K	S5M	D24 - 24VDC	BN - Brown			OC - VVD209
PM	070	Y - 570-575nm	S1S		CS - Custom (Specify Pantone)			RC - VVD201
TM	084	R - 620-625nm	S1SH					TR - VVD200
WM	098	G - 520-525nm	S1M					
RB	112	B - 470-475nm						
	126	CS - Custom (Specify Temp)						
	140							

ORDERING: Send a PO to your representative. If no rep is present, send to orders@vividleds.us or fax to 800-974-3570.