

Mineral Fiber Building Insulation

Recommendations for Installing
Mineral Fiber Insulation
in Residential and Other
Light-Frame Construction





Reviewed by
Insulation Contractors Association of America

Contents

08-01-11	a1	How to Install	7
Introduction	1	Grading Installation Quality	7
Product Benefits	1	Attic Areas	7
Heat Control	1	Sidewalls	8
Sound Control	1	Floors	9
Moisture Control	1	Basement Walls	10
Product Information	1	Crawl Spaces	11
How Is Insulation Labeled?	1	Garage Areas	12
FTC Home Insulation Rule	1	Insulating Around Obstacles	12
Types of Building Insulation	2	Vapor Retarders	13
Unfaced Insulation	2	What Does a Vapor Retarder Do?	13
Insulation Sizes	2	Types of Vapor Retarders	13
Air Infiltration	2	When is a Vapor Retarder Required?	13
Where is Insulation Installed?	2	Vapor Retarders in Cold Climate Zones (5, 6, 7 and Marine 4)	14
Areas To Insulate	3	Vapor Retarders in Warm Climate Zones 1, 2, 3 and 4	14
Installation Techniques	3	Cautions	14
Unfaced Insulation	4	Other Vapor Retarder Materials	14
Lay-In	4	Ground Covers	15
Narrow-Framed Cavities	4	Final Inspection	15
Small Cavities	4	Clothing and Equipment	15
Cantilevered Overhangs	5	Equipment	15
Interior Soffits and Drops	5	What NAIMA Tells Consumers	15
Insulating at Bridging	5	Material Specifications	15
Double or Staggered-Stud Wall	5	Thermal Recommendations and Codes	15
Steel Stud Walls	5	Department of Energy R-Value Recommendations	16
Unfaced and Faced Insulation	5	Appendix: 25 Check Points for Inspecting Insulation Jobs	17
Securement	5	ICC Air Barrier And Insulation Inspection Component Criteria	18
Vapor Retarder Location in Warm and Moist Climates	7	About NAIMA	20
Scheduling Insulation Work	7		
Special Situations	7		

Introduction

Fiber glass and rock and slag wool insulations are the most widely used insulation products on the market. Their proven dependable performance and environmental benefits help homeowners and building owners save money on their energy bills and reduce greenhouse gas emissions. For optimum performance, it is important that you understand what the products are, where they are designed to be used, and how to properly install them.

Product Benefits

Fiber glass and rock and slag wool insulations are effective in helping reduce heat flow, reduce unwanted noise, and control moisture.

Heat Control

Insulation resists the flow of heat. Heat is a form of energy. By reducing heat flow in a properly insulated building, less energy is used for winter heating and summer cooling. Insulating today will help save both dollars and energy. Savings vary. Find out why in the seller's fact sheet on R-values. The higher the R-value, the greater the insulating power.

Sound Control

Insulation reduces sound transmission. An insulated floor, wall or ceiling will have an improved Sound Transmission Class (STC) compared to a similar building section with no insulation. As an example, 3-1/2 inches of fiber glass insulation in a wall can improve the STC from 3 to 10 points, depending upon construction details.

Moisture Control

A vapor-resistant membrane (commonly called a vapor retarder) attached to batt or roll insulation, or installed separately, decreases the possibility of moisture vapor condensing to water within the structure.

Product Information

Fiber glass and rock and slag wool insulations are well tested products and are continuously tested to assure they meet a variety of product standards.

The basic materials such as sand and recycled glass for fiber glass, and basalt and industrial slag for rock and slag wool, are melted and then spun into wool-like fibers. These are processed into batt or roll insulation, with or without facings, and in loose form

for pneumatic blowing applications. See *ASTM C 665 (Mineral Fiber Blanket Thermal Insulation for Light Frame Construction and Manufactured Housing)*. For more information on ASTM Standards, ask for *NAIMA Facts #8: ASTM Standard Specifications for Mineral Fiber Blanket, Loose-fill and Spray-Applied Insulation*.

How Is Insulation Labeled?

Building insulation is identified and labeled by R-value. "R" stands for resistance to heat flow. (The higher the R-value the greater the insulating power. Ask your seller for the fact sheet on R-values.) The R-values are printed on the insulation batts and rolls. Most common R-values of batts and rolls are 11, 13, 15, 19, 21, 22, 25, 30, and 38. R-values can be added. If, for example, a ceiling requires R-38 insulation, two layers of R-19 batts or rolls can be used.

Note: When batts or rolls are compressed to less than the design thickness during installation, the installed R-value will be reduced.

FTC Home Insulation Rule

The United States Federal Trade Commission's (FTC) Labeling and Advertising of Home Insulation Rule requires installers to provide each customer (builder or consumer) with a signed and dated contract or receipt for the insulation installed. The receipt must show the coverage area, thickness and R-value of the insulation installed. This applies to all insulation except loose-fill and aluminum foil (16 C.F.R. §460.17). The manufacturer must provide a manufacturer's fact sheet. Installers must have this information and show it to customers before they agree to buy the insulation.

A new-home seller must put the following information in every sales contract: the type, thickness, and R-value of the insulation that will be installed in each part of the house (16 C.F.R. §460.16).

Types of Building Insulation

Faced Insulation

Batts and rolls are available with facings already attached. The facing material is usually a vapor retarder. Vapor retarding facings usually consist of asphalt-coated kraft paper, aluminum foil or plastic film. A vapor retarder's purpose is to resist the movement of moisture vapor to colder surfaces where it could condense to water.

Most facings extend over the sides of the insulation to provide flanges that can be stapled to wood framing to hold the insulation in place when recommended by the manufacturer. Some faced products may be pressure fit between framing without stapling. Pressure fit is acceptable for standard wall heights but for walls that are above 8 ft. you may want to consider stapling to keep in place until drywall is installed. (See Figure 1.)

Figure 1

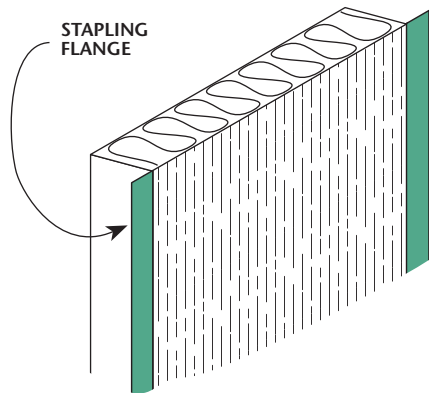

Carefully read the manufacturer's directions printed on the insulation packaging to be sure the material is correctly installed.

Unfaced Insulation

Unfaced wall insulation is usually made wider to permit installation by pressure fitting between either wood or metal framing. No fastening is required if the insulation material is enclosed on all four sides and fills the cavity, as in a typical wall cavity installation.

Insulation Sizes

Insulation is packaged as batts or rolls and is available in a variety of sizes. Not all sizes are produced by every manufacturer. The following table represents common material sizes.

Air Infiltration

For optimum energy efficiency, a well-insulated building must also be treated to eliminate air leaks in and out of the building. It is necessary to properly air seal the thermal envelope of each home. Air sealing is required in the latest International Energy Conservation Code

and International Residential Code codes. (See Appendix.) The U.S. Department of Energy provides good information for air sealing new and existing homes on its website at www.energysavers.gov. The following information is from the 2006 IECC, Section 402.4.1.

The building thermal envelope shall be durably sealed to limit infiltration. The sealing methods between dissimilar materials shall allow for differential expansion and contraction. The following shall be caulked, gasketed, weatherstripped or otherwise sealed with an air barrier material, suitable film or solid material:

1. All joints, seams and penetrations
2. Site-built windows, doors and skylights
3. Openings between window and door assemblies and their respective jambs and framing
4. Utility penetrations
5. Dropped ceilings or chases adjacent to the thermal envelope
6. Knee walls
7. Walls and ceilings separating a garage from conditioned spaces
8. Behind tubs and showers on exterior walls
9. Common walls between dwelling units
10. Attic access openings
11. Rim joists
12. Other sources of infiltration

A major area of air infiltration is the attic opening. Whether a simple "scuttle hole" or a more finished opening with a stairway or pull-down stairs, this opening should be thoroughly sealed and insulated. There are several insulated attic hatch covers that are excellent for this application. For more information on air sealing, visit the Air Sealers Institute of American at www.airsealers.com.

Nominal Dimensions Available

	Batts	Rolls
Lengths	47" (1194 mm), 48" (1219 mm)	39'2" (11.94 M)
	90" (2286 mm), 93" (2362 mm)	40' (12.19 M)
	94" (2388 mm), 96" (2438 mm)	70'6" (21.49 M)
Widths	11" (279 mm), 15" (381 mm)	11" (279 mm)
	15¼" (387 mm), 16" (406 mm)	15" (381 mm)
	23" (584 mm), 23¼" (590 mm)	23" (584 mm)
	24" (610 mm)	

Where is Insulation Installed?

Insulation is designed for use in framing members of residential and other light-frame constructions. Standard widths are available for 16 and 24-inch on-center spacing; special widths are available for steel studs. A batt is a pre-cut piece of insulation, usually 47 to 96 inches in length. Rolls are available in lengths up to 70 feet.

Figure 2

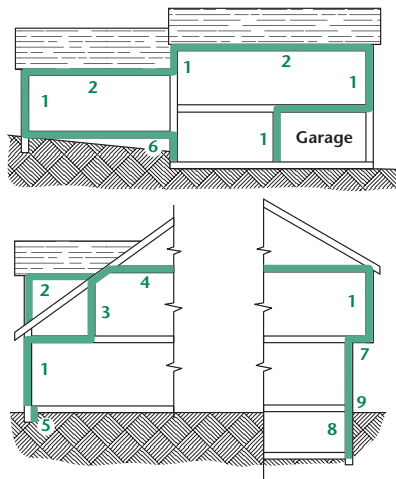

Areas To Insulate

(Numbers refer to locations in Figure 2.)

1. Exterior walls. Sections sometimes overlooked are walls between living spaces and unheated garages or storage rooms, dormer walls, and the portions of walls above ceilings of adjacent lower sections of split-level homes.
2. Ceilings with cold spaces above, including dormer ceilings.
3. Knee walls of attic spaces finished as living quarters.
4. Sloped walls and ceilings of attic spaces finished as living quarters.
5. Perimeters of slabs on grade.
6. Floors above vented crawl spaces. Insulation may also be placed on crawl space floors and walls.
7. Floors over unheated or open spaces such as over garages or porches. Floors over unheated basements. The cantilevered portions of floors.
8. Basement walls.
9. Band or header joists, the wall sections at floor levels.
10. Interior walls, ceilings and floors where sound control is desired. (Not shown on Figure 2.)

Although they are not shown, common walls and floors between separately heated apartment or townhouse units should be insulated. In addition to its thermal benefit, the insulation improves sound attenuation and fire resistance.

Installation Techniques

Faced Insulation

There are three commonly accepted methods of installing faced insulation in wood framing members: pressure fit, face and inset.

Pressure Fit or Friction Fit — No Stapling

Both faced and unfaced batts can be installed by pressure fit or friction fit unless stabilizing is needed — for example, in walls that are higher than 8 ft. It is

important that the insulation completely fill the cavity. In walls that are higher than 8 ft, use minimal stapling to hold insulation in place until drywall is installed. To install faced products by pressure fit, gently place the insulation into the cavity space between framing. Make sure the insulation facing is flush with the face of the stud. The insulation must fit snugly at the sides and ends.

Face Stapling

Place the insulation between framing members and check to be sure it fits the cavity at both ends. With facing material flush with the face of the framing, the flanges will overlap the framing. Staple the flanges to the face of the framing, using enough staples to hold the insulation firmly in place and avoid gaps and fishmouths. The flange of the faced insulation placed in the next cavity will overlap the previously stapled flange. (Refer to Figure 3A.) When more than one batt is used in a single cavity, pieces must be snugly butted without gap between them.

Figure 3

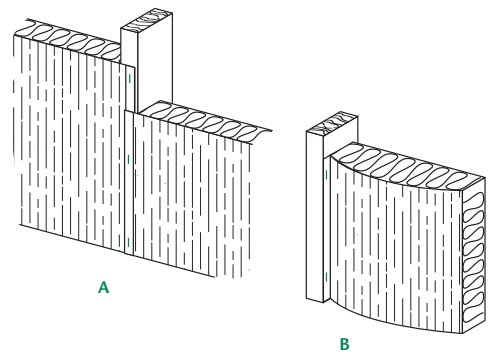

Inset Stapling

When insulating sidewalls, place the insulation in the cavity and check to be sure it completely fills the cavity, top to bottom. When insulating ceilings, be sure that each batt is butted closely to the next one before fastening. Gently press the insulation at the sides into the framing cavity, usually about 3/4 inch, until the outside edge of the flange is flush with the face of the framing. When inset stapling insulation between inclined or vertical framing members, as in cathedral ceilings or walls, start stapling at the top and work down. Use enough staples to hold the insulation firmly in place and avoid gaps and “fishmouths” between flanges and framing, approximately every sixteen inches. (Refer to Figure 3B.) Remember, compressing insulation to fit a cavity may result in some loss of R-value, therefore don’t inset the tabs any further than necessary for stapling. Using denser batts does not require stapling; the batts are held in place by friction. Materials installed in this manner minimize insulation compression. Note: Inset stapling is not permitted in Canada.

Compressing Insulation

Compressing insulation can improve the R-value of the wall - as long as the insulation is not compressed such that it does not fill the cavity front to back. When batts are compressed so they are thinner than the cavity they are intended to fill, compression will result in a wall with a lower overall R-value.

Example – Compressing Batt Insulation Behind Wall Blocking

Compressing a full piece of insulation into the small cavity shown so it fills it is the best way to insulate the space. Because compressing R-13 (3-1/2") batt material, into 2" deep cavity results in a higher density batt with an R-value of approximately R-10.

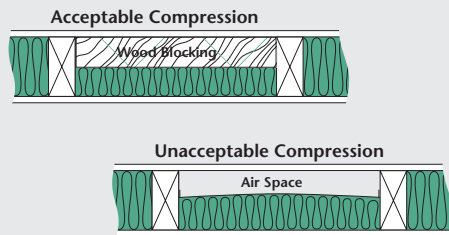

Inset or Face Stapling?

Both inset and face stapling are widely used and can provide acceptable performance. Inset stapling is usually preferred by the wall finish trades because it allows adhesive application of wallboard. Most commonly used vapor retarders which come attached to the batts are flammable and can not be left exposed. During construction they should be covered with the interior finish material, such as drywall, as soon as possible. When the ICC codes (International Residential, Building or Energy Conservation Code) require a vapor retarder, batts which are inset stapled meet that requirement. A copy of the ICC code interpretation is available from NAIMA upon request.

Unfaced Insulation

To install unfaced insulation, gently place the insulation into the cavity space between framing members. It is important that insulation be correctly sized for the cavity and fit snugly at the sides and ends. No fastening is required if the insulation material is held in place on all four sides and fills the wall cavity. The insulation in knee walls (see Figure 2, item 3) should be held in place to prevent the insulation from falling out of the wall cavity over time.

Note: Wherever batts or rolls of any type are too short to fill a stud cavity, a piece should be cut to size to fill the gap. When insulation is too long, it should be cut to fit properly, not doubled over or forced to fit.

Lay-In

After the ceiling finishing material has been applied, faced or unfaced insulation can be laid between

framing members and gently pressed into place. Ceiling insulation is held in place by gravity. Vapor retarder facings should face down in ceilings in most climate areas.

There are four techniques for holding insulation in place between floor joists. These are described in the "How to Install" section which starts on page 8.

Narrow-Framed Cavities

Insulate non-standard-width framed spaces by cutting the insulation and facing about an inch wider than the space to be filled and friction fit the batt into the cavity.

Small Cavities

Custom cutting of insulation may be required for less-than-standard width or length cavities or for insulating around window and door framing, stud corners, band joists, and between chimneys and framing. If a faced material is used, and the space, such as at window framing, is narrow, the insulation may be pulled away from the facing in small pieces and stuffed into the narrow space. (See Figure 4.) Small spaces between studs at the corners of buildings and at intersections of partitions and sidewalls should be treated in the same manner before the sheathing is applied. Where a vapor retarder is required, cover the warm-in-winter side of the narrow space with excess vapor retarder facing. Band joists and headers between floors should be air-sealed and insulated. At the band joist, or rim joist, the insulation should be allowed to overlap the sill plate. Small cavities or cracks can be caulked or sealed with cans of spray foam.

Figure 4

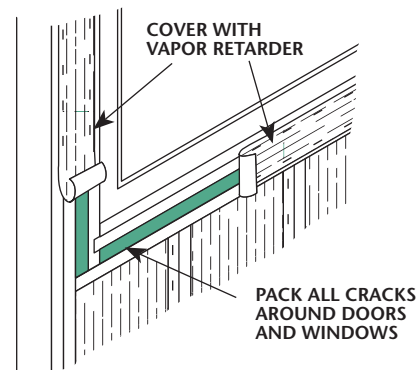

Caution

Clearances around fossil-fuel appliances, chimneys and other hot surfaces should meet the requirements of the National Fire Protection Association (NFPA) and International Code Council (ICC) building codes, or the appliance manufacturers' recommendations. Use only unfaced insulation between wood framing and masonry chimneys. Do not place insulation in air spaces surrounding metal chimneys or fireplaces unless they are designed to be in contact with insulation.

Cantilevered Overhangs

These areas must not be overlooked. If the underside of the cantilever has been closed, insulation must be installed by sliding batts into place from the room below. (See Figure 5.)

Figure 5

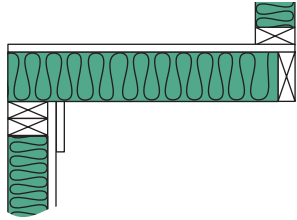

Interior Soffits and Drops

Interior soffits and drops, usually located over cabinets and bathrooms, should be constructed in a manner to allow proper insulation. Gypsum board or other suitable material can be applied to the underside of ceiling joists to enable the installation of insulation and air-seal the space to prevent air from by-passing the insulation.

Insulating at Bridging

Metal bridging or cross bracing can be insulated simply by butting the batts to each side of the cross brace. Wood bridging or cross bracing of ceiling or floor joists is insulated by splitting a batt diagonally at the brace angle and packing one half into the lower opening and the other half into the upper opening. (See Figure 6.) Another method is to butt the insulation to the bridging, then fill the bridging space with scrap or loose insulation. There should not be any uninsulated gaps either above or below the brace.

Figure 6

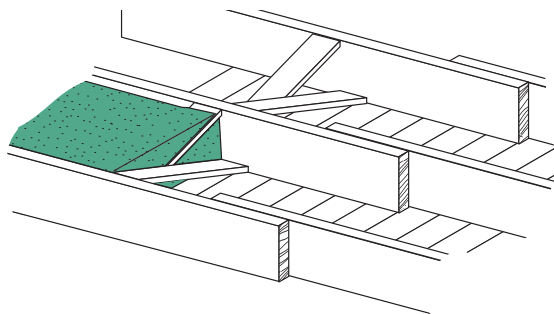

Double or Staggered-Stud Wall

The super-insulated wall is a double-frame providing a double-depth cavity. The studs are staggered to eliminate thermal and sound paths. Unfaced batts are used in the outer wall. If desired, a vapor retarder may be applied to the inner stud wall either separately or by using faced batts. (See Figure 7.)

Figure 7

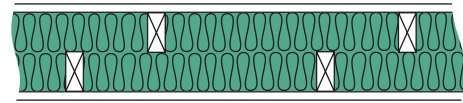

Steel Stud Walls

Steel conducts heat more readily than wood — for this reason steel stud walls require special insulation details. Insulating sheathing on the exterior side of the wall, with joints and penetrations properly sealed, can improve the thermal performance and reduce the infiltration and exfiltration of moisture-laden air into the wall cavity. Because the steel studs can be below the dewpoint temperature of the air inside the wall it is also important to have a properly installed internal vapor retarder. (See Figure 8.)

Figure 8

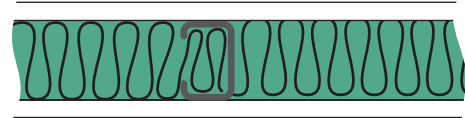

Unfaced and Faced Insulation

Both faced and unfaced insulation in steel stud walls should be the same width as the stud spacing, typically 16 or 24 inches. The batt should be fit tightly into the open channel of the stud (see Figure 8). The batt should be cut to fit the entire stud cavity and should be tucked into the open channel of the steel stud, which helps support the batt and makes the insulation layer as continuous as possible. For batts with vapor retarder facings, placing the batt and the vapor retarder into the stud helps support the batt. Some installations require that the flange of the facing be taped or adhered to the face of the steel stud for support when practical, completely filling the cavity to help ensure insulation remains in place.

High performance or high-density batts do not require additional batt support with any type of attachment up to a height of 10 ft. to 12 ft. Standard materials that are not as stiff may require the use of clips to prevent them from slipping down within the wall cavity over time.

Securement

When cavities are more than 8 ft. high, or you are using standard or lighter density batts, or insulation does not completely fill the cavity, mechanical securements are necessary.

Tape Method

Place the facing flat against the face of the stud. Tape the tab to the stud using 4 inch to 6 inch pieces of duct tape, contacting the facing and wrapping around on the stud. Install the adjacent piece of insulation in a similar manner. Allow the tab of this piece to lay on top of the adjacent piece and tape flat. When gypsum board is installed, the tabs are continuously impaled between the gypsum board and stud face. When tabs are laid flat, they will not interfere with gypsum board. (See Figure 9.)

Figure 9

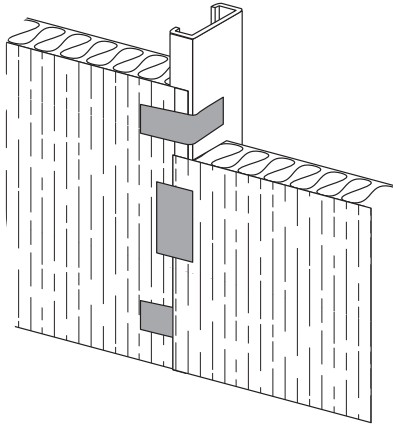

Mechanical Fasteners

Various forms of mechanical fasteners may be used to secure insulation in a stud cavity. If backing material is nailable, common nails can be used through body of insulation into backer material. (See Figure 10.) Do not nail so as to compress insulation more.

Figure 10

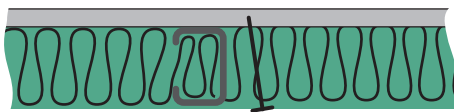

Stick Pins

Glued to backer, stick pins may be used to hold insulation in place. (See Figure 11.) Any type of these fasteners should be spaced no more than 48 inches apart vertically. There are also patented fasteners such as “INSULHOLD” hangars available for this purpose. These also should be spaced no more than 48 inches vertically. (See Figure 12.) Any such fasteners used should be sufficient to hold the weight and keep the material in place. Where the stud cavity is completely filled, it is sufficient that fasteners only hold the material in place until the gypsum board is installed. In all cases, it is important that the installed thickness not be compressed with the use of fasteners to the extent that installed R-value is reduced.

Figure 11

Various Pin Types

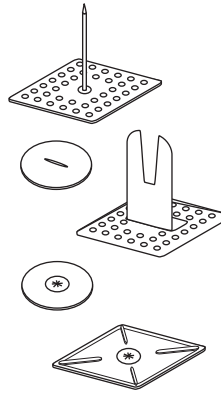

Pin layouts where surface will not have regular stud and drywall finish

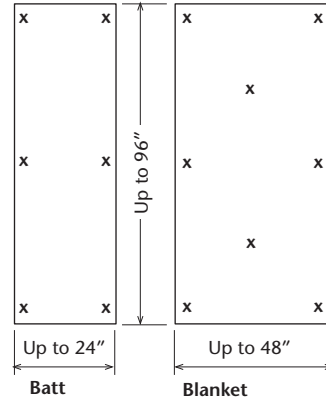
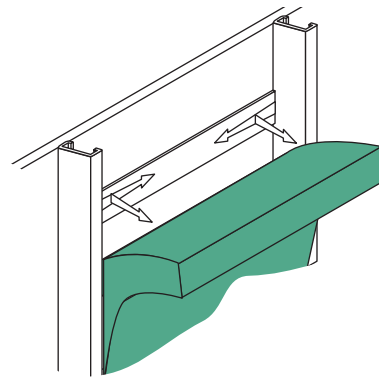

Figure 12



Furrings

Studs are often furred out from wall structure leaving a cavity between back of wall and stud. Whenever possible, it is better to install insulation directly against the exterior structure rather than in the stud space. This gives continuous thermal coverage and will reduce the chance of condensation from forming on the interior of a masonry wall. If cavity is deeper than insulation thickness, mechanical fastening is required. (See Figure 13.)

Figure 13

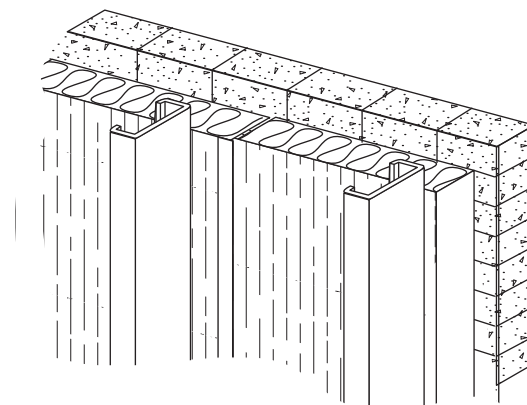

Furrings above store front, entryways and at back of soffits present special problems. In these cases, adequate mounting for insulation must be provided. A stud system with an exterior sheathing to seal off the space and insulation between the studs is best. A “hanging wall” of unsupported insulation to close such areas should not be depended upon to provide either thermal or air infiltration control. (See Figure 14.)

Figure 14

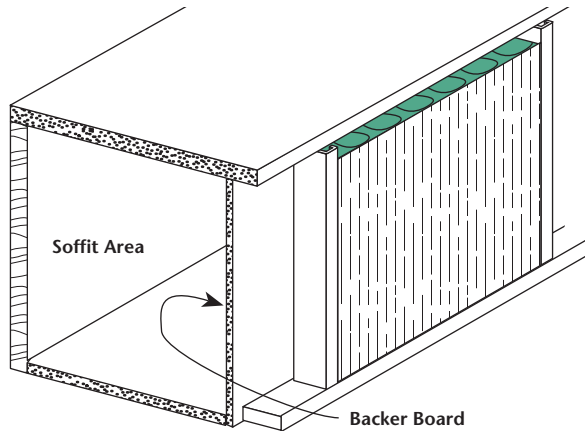

Vapor Retarder Location in Warm and Moist Climates

In warm climates where high humidity conditions occur on a regular basis, vapor retarders should not be installed on the interior side of the building. In these warm humid climates, it is permissible, but not required, to install batts with the vapor retarder on the exterior side of the building. Warm and moist climate areas, such as the Gulf Coast and Southern portions of the U.S. Atlantic coast, are shown in the climate zone maps in the International Energy Conservation Code and ASHRAE 90.1 Standard. In warm climates where high humidity is not a factor, such as the Southwest U.S., vapor retarders are not required, but if a vapor retarder is installed it may be installed to either the interior or exterior of the building. For additional information on vapor retarders refer to the vapor retarder section on pages 13 and 14.

Scheduling Insulation Work

Construction debris must be removed from spaces to be insulated. Insulation should be installed just before the interior finish is applied. This means that the following-listed work, as applicable, has been performed.

- Foundation walls are in place. Sidewalls, floors, roof and ceiling have been framed.
- Roofing is finished and doors, windows, sub-flooring and sheathing are in place.

- Plumbing, wiring (including telephone and other low-voltage wiring) and heating, ventilating and air conditioning work have been completely roughed in. If any part of this work is done following the installation of the insulation, the vapor retarder may be damaged and gaps may be made in the insulation. Openings in the insulation or vapor retarder will reduce the effectiveness of the material.

Special Situations

In some constructions, it will be necessary to install part of the insulation before the sheathing is applied or before the mechanical or electrical work is roughed-in. These are areas that will be impossible or difficult to insulate later, such as where plumbing fixtures are next to outside walls and at soffits or overhangs.

Where attics are accessible, ceiling insulation may be installed from the attic space after the ceiling finish is in place. Many roofs, however, are of shallow pitch, making it difficult to insulate the outer edges of the ceiling from above. The work, therefore, is best accomplished before the ceiling finish is installed.

Floors over unheated spaces that will not receive a bottom surface may be insulated at any time after the subflooring and mechanical and electrical work are complete.

How to Install

Wherever insulation is installed in a building, it is very important that it fit snugly on all sides. If the insulation is too long for a space, cut it to the correct size. If it is too short, cut a piece to fill the void.

Grading Installation Quality

There are several protocols for grading the quality of insulation installations. The most widely recognized grading criteria was developed by the Residential Energy Services Network (RESNET) an organization of experts in rating the energy efficiency of homes. When grading is necessary, NAIMA recommends using the RESNET criteria and installing the materials with a Grade I quality.

Attic Areas

New Construction

When ceiling insulation is installed at the same time as wall insulation, it is usually installed from underneath. Batts (faced or unfaced) are installed between ceiling joists and butted together. Faced batts should be stapled to joists unless the manufacturer recommends pressure fit applications and should extend to the outer edge of the exterior wall's top plate. (See Figure 15.)

No stapling is required if insulation is laid in over finished ceilings. The facing should be toward the living space.

Figure 15

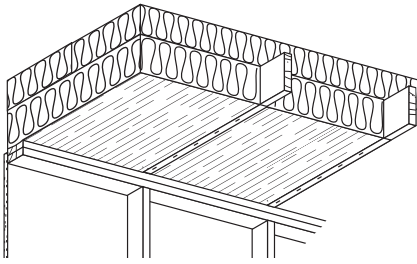

In attics with pre-engineered trusses and where more than one layer of insulation is to be installed, the best job is achieved by installing all of the insulation parallel to and between the bottom chords. In attics with conventional joists and rafters, the first layer of insulation is installed between the joists and should be at least the same height as the joists. (See Figure 15 above.) The second layer is applied perpendicular to the joists. This method provides the most complete thermal protection.

It is particularly important that clearance for air movement from eave or eave vent openings be maintained. If there are soffit vents, there should be about 1-inch of unblocked free air space between the roof sheathing and the insulation. It is important also for the insulation to cover the top plate. Use baffles if necessary to keep the insulation from blocking the flow of air between the soffit and the attic. Install an air barrier (soffit dam) made of durable material that is permanently attached to the attic framing at the outer most edge of the attic insulation. This will prevent the air ventilating the attic from passing through the attic insulation. (See Figure 16.)

Insulation near recessed fixtures should be kept at least 3 inches from the fixtures in accordance with the recommendations of the current National Electrical Code. This warning does not apply to Type IC (Insulation Contact) fixtures or fluorescent fixtures with thermally protected ballasts.

Prior to installing insulation in contact with vents, chimneys, electrical fixtures and other items that may get hot, verify the item can have insulation in contact with it.

Figure 16

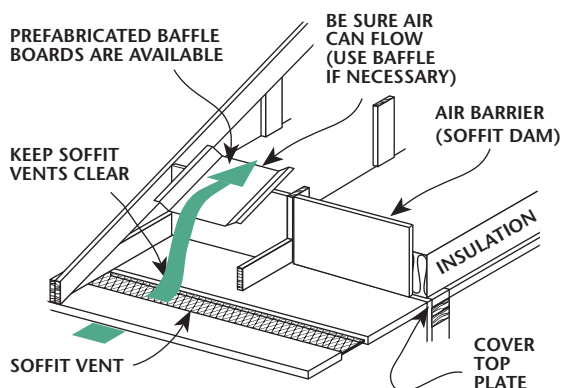

Existing Homes

In homes with existing attic insulation, unfaced insulation should be installed using the same installation principles as with new homes. If the insulation has a vapor retarder, remove it if the new insulation is installed on top of existing insulation.

Cathedral Ceilings

In cathedral ceilings the insulation should be stapled or held in place by pressure against the sides of the rafters. An air space between the insulation and roof sheathing, ventilated at the ridge and soffit, is desirable in cathedral ceilings. If unfaced material is used, a separate vapor retarder should be applied facing the living area after the insulation has been installed.

Where attics are accessible, ceiling insulation can be installed from the attic space after the ceiling finish is in place. Many roofs, however, are of shallow pitch, making it difficult to insulate the outer edges of the ceiling from above. The work, therefore, is best accomplished before the ceiling finish is installed.

Attic Rooms

Attics that are used as living spaces should be insulated as shown in Figure 17.

Figure 17

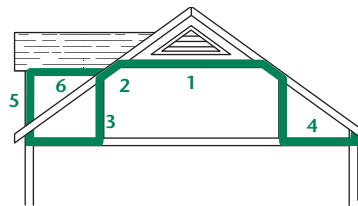

- (1) Between collar beams. (2) Between rafters.
- (3) Knee walls. (4) Ceilings with cold spaces above.
- (5) Dormer walls. (6) Dormer ceilings.

Sidewalls

New Construction

Standard Walls

Insulation should fit snugly within the framing cavity without gaps or voids between the edges of the batt and the framing members. When inset stapling batts, a small void adjacent to the stud where the flange is stapled flush with the front edge of the stud is permissible (see Figure 3A on page 3.) Even the smallest openings between framing members should be insulated.

Recommendations applicable to insulating walls are discussed in Installation Techniques (See page 3.)

2x6 Walls

For optimum thermal performance walls with 2x6 framing (or larger) should be filled with insulation. Installing 3-1/2 inch thick insulation in a 5-1/2 inch wall cavity is considered substandard construction practice. The recommended practice is to completely fill the wall cavity.

Knee Walls

Insulation installed in knee walls (see figure 2, item 3, on page 3) should be secured to prevent it from falling out of the cavity and covered with an air barrier material on the unconditioned side of the wall. The air barrier should be a durable material which is permanently attached to the wall framing. Examples of acceptable air barriers include, but are not limited to housewrap attached with plastic cap nails, thin plywood or OSB attached with standard nails and extruded polystyrene attached with roofing nails or comparable fasteners. Confirm the air barrier materials exposed on the unconditioned side of the wall comply with any applicable fire safety requirements in the building codes. When unfaced insulation is used a proper vapor retarder must be installed on the appropriate side of the insulation in accordance with the vapor code requirements in the building code. Refer to the vapor retarder section on page 13 of this document for further information.

Existing Homes

Insulating walls of existing homes is a difficult task. Either insulating from the outside or inside requires removal of the existing materials. A more common method is to blow in loose-fill insulation. Manufacturers produce fiber glass and rock wool materials specifically designed to be blown into existing wall cavities through small access holes.

Interior Walls

Interior walls may be insulated to provide sound control. Either faced or unfaced insulation may be used, but faced insulation is generally easier as the tabs can be used to hold the insulation in place. Denser batts do not require stapling and are held in place by friction.

Floors

Insulation is installed between floor joists, and secured as follows:

Wire Fasteners

The easiest and most effective method of holding insulation in place is to use straight, rigid wire fasteners, (preferably galvanized,) with pointed ends. The fasteners are made for joist spacings of 12, 16, 18, 20 and 24 inches and may be used against wood, metal, or concrete. The fasteners, which are slightly longer than the joist spacing, are placed by hand between the joists and bowed upwards into the

insulation, causing the insulation to be in contact with the subflooring. Install the fasteners so they hold the insulation in contact with the subfloor but avoid unnecessary compression. Spacing of fasteners is as required to prevent sagging of the insulation, normally 12 to 24 inches apart and not more than 6 inches from ends of the insulation. (See Figure 18.)

Figure 18

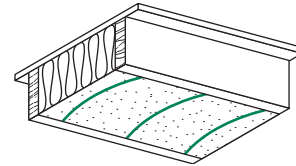

Mesh or Screen

Galvanized wire, nylon mesh or galvanized screen (chicken wire is also suitable) will hold the insulation in place. After the insulation has been pushed into place the mesh or screen is stapled or nailed to the joist faces. (See Figure 19.)

Figure 19

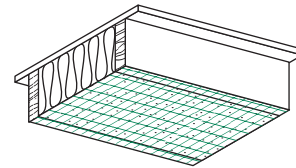

Wire Lacing

Galvanized, malleable wire may be laced around nails protruding from the faces of the joists or the wire may be stapled to the joists. Wire and nail spacings are as required to prevent sagging of the insulation. (See Figure 20.)

Figure 20

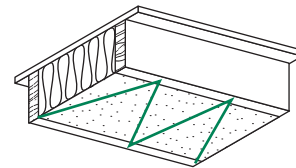

Note: For homes where the underside of the floor is exposed and readily accessible, such as homes on pilings or certain garage areas, the insulation should be covered with a suitable exterior material to protect it from high winds and physical abuse. Header and band joists should also be insulated and air-sealed.

When insulating floors where the insulation is less than the thickness of the joists and the method of installation does not hold the insulation up against the subflooring, the headers or band joists at outside walls must be insulated. This is because there will be

an air space between the top of the insulation and the subfloor which will allow heat to bypass the installation. Therefore, it is recommended that the insulation be pushed up to the subfloor. If insulating over an unheated area, the vapor retarder should be in substantial contact with the subfloor. Where the header is parallel with the floor joists it may be necessary to adhere insulation to the header or fill the joist area with insulation. (See Figure 21.)

Figure 21

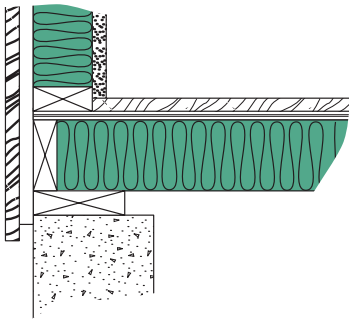

Open Web Trusses — Wood

Effectively insulating open web, wood trusses with batts can be difficult. When using batts, they must be carefully cut and fit between the openings in the webs and supported by rods or wire. Consider insulating this type of assembly with loose fill fiber glass blown above a mesh-type membrane attached to the lower chords of the trusses. When a vapor retarder is required, the supporting material should have a rating of less than 1 perm.

Open Web Trusses — Steel

Open web steel trusses should be insulated with batt or blanket insulation. The insulation should be placed snugly within the floor cavity so that the edge of the insulation expands into webs of the steel truss and contacts the insulation in the adjoining floor cavity. The insulation should be installed at the bottom chord and supported using wire fasteners, wire mesh/screen or wire lacing.

Consider insulating this type of assembly with loose fill fiber glass blown above a mesh-type membrane attached to the lower chords of the trusses. If a vapor retarder is required, the supporting material should have a rating of less than 1 perm.

Pre-Engineered Trusses (I-Shaped)

For spacings greater than 24 inches, consider wide roll insulation format or contact a metal building laminator. Pre-engineered trusses should be insulated by installing the insulation at the bottom chord of the truss and supported using wire fasteners, wire mesh/screen, wire lacing or mesh-type membrane. If a vapor retarder is required, the

supporting material should have a rating of less than 1 perm.

Basement Walls

Unconditioned Basements

Most manufacturers produce a special product for insulating walls of unconditioned basements. They come in rolls or batts that are attached to the top of the basement wall and hang down to either partially cover or fully cover the basement walls, depending on the local building code. The material is typically supplied with a fire rated facing which protects the insulation material.

Conditioned Basement Walls

Prior to insulating basement walls with any of the following methods, insulate the band joists separately.

Furring Strips on Masonry or Concrete

Masonry wall insulation ranges from R-6 to R-8, (1-1/2 to 2-1/2 inches thick) and is unfaced. It is available for use with furring strips 16 and 24 inches on center. After the furring strips are mounted on the wall, the insulation is placed between the furring strips and is held in place by pressure at its sides. Be sure the insulation fits tightly at top and bottom.

If the vertical furring strips are aligned with the floor joists above and do not abut an upper horizontal furring strip, the insulation should extend into the space between the joists to insulate the sill and the header. Where the floor joists run parallel with the wall (no joists meet the header), secure the insulation to the sill and insulate the header separately. If a vapor retarder is desired, polyethylene film or foil-backed gypsum board can be installed.

Masonry or Concrete with Framing

When insulation of higher R-values (R-11, R-13, R-15, R-19 or R-21) is to be installed on a masonry wall, a separate frame wall may be built of 2 x 4 or 2 x 6 studs.

The top plate is nailed to the underside of the joists or to blocking between joists.

Attachment of the insulation to the framing is the same as for sidewall insulation. Here, too, faced or unfaced insulation may be used, with the vapor retarder applied the same way. Standard vapor retarder facings must be covered with the interior finish material (paneling, 1/2 inch gypsum board, or the equivalent). Only special low flame-spread vapor retarder facing can be left exposed. Consult individual manufacturers' instructions. (See Figure 22.)

Figure 22

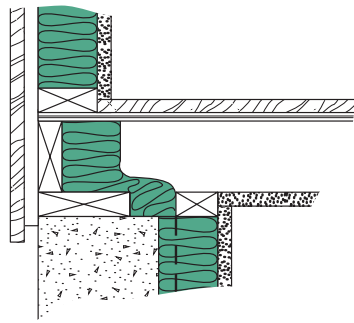

All Weather Wood Foundation

Insulation is installed in the same way as in framed walls elsewhere in the building.

Sill Sealer Insulation

Sill sealer is normally available in 50- to 100-foot rolls, up to 6 inches wide and 1 inch thick. Placed between the top of masonry foundations and the sill plate, it resists heat loss by reducing air leaks, keeps out insects, and reduces the need for caulking. After laying the sill sealer on the foundation wall, the sill plate is fastened, compressing the sill sealer between the foundation wall and the sill plate.

Crawl Spaces

In most cases, crawl spaces should be vented. Therefore, the walls or the floor above should be insulated. If ducts and/or plumbing are in the crawl spaces, it may be preferable to insulate the crawl space walls.

If you are insulating the floor above the crawl space, insulate as detailed in the section on Floors (page 9). A vapor retarder should be installed covering the ground to prevent moisture from entering the crawlspace. The vapor retarder ground cover should be a minimum of 6 mil polyethylene sheeting with the joints lapped at least 6 inches and sealed. The edges should extend a minimum of 6 inches up the wall and be sealed to the wall using adhesive caulking.

Masonry Walls

Furring members to hold the insulation in place are unnecessary. If vapor-retarder-faced insulations are required, use only special low flame-spread vapor retarders recommended for exposed applications. The vapor retarder should, in most cases, face toward the crawl space, the warm-in-winter side. Consult individual manufacturers' instructions. Two methods of installing insulation are recommended.

First, after insulating the band joist separately, nail the insulation to the sill plate with 1/2 x 1-1/2 nailer strips. (See Figure 23.) The insulation should be snug against the piece next to it. The insulation should hang down to the bottom of the wall and extend out onto the ground cover (usually polyethylene) about 2 feet. Where the insulation bends onto the vapor retarder on the ground, the insulation should be held in place by using weights such as bricks or rocks placed on the edge of the insulation.

Figure 23

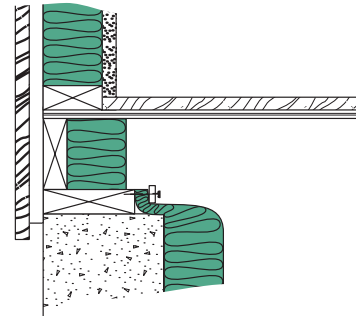

An alternate method of insulating masonry walls is to run the insulation up the wall, past the sill plate to the subfloor. Again, insulate and air-seal the band joist separately. (See Figure 24.)

Figure 24

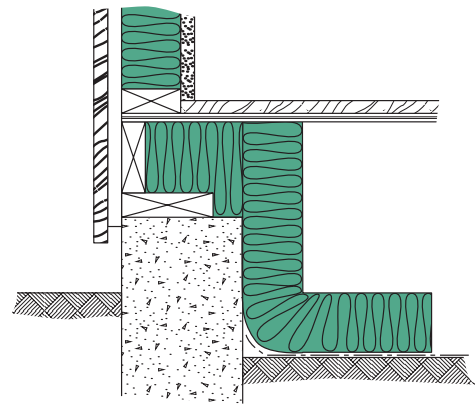

All-Weather Wood Foundation

Insulate the band joist separately. Where the crawl space floor is concrete, install the insulation as recommended for wood-frame walls. If the crawl space floor is soil, apply the insulation and the vapor retarder ground cover. (More information on ground cover is detailed on page 15.)

Garage Areas

In most cases, garages are unconditioned spaces and should be insulated as such. Both garage ceilings and walls that are connected to living spaces should be thoroughly caulked and sealed to prevent dangerous fumes from entering the living space.

Figure 25

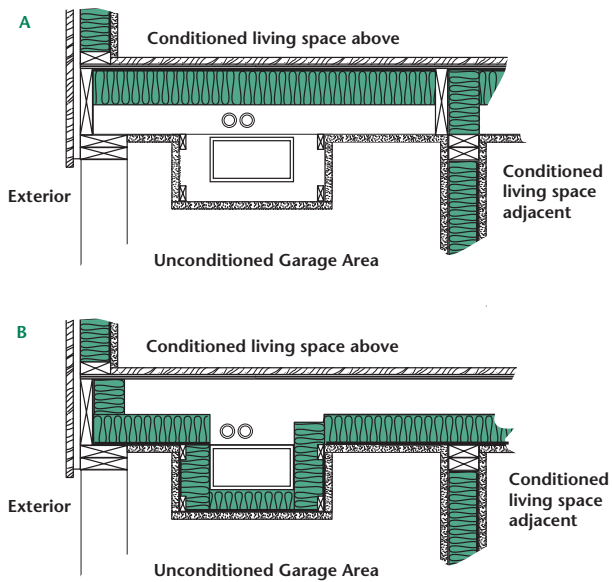

Garage Ceilings

When installing insulation in a garage ceiling beneath a living space, there are two acceptable practices. The preferable practice is to install the insulation at the top of the cavity in contact with the bottom of the subfloor sheathing. In this case when the batts have a vapor retarder, it shall be installed with the vapor retarder upwards and in substantial contact with the subfloor as shown in Figure 25A. It is also acceptable to install unfaced batts in this manner, because the subfloor sheathing will serve as a vapor retarder. The insulation should be properly supported using wire fasteners, wire mesh/screen or wire lacing as shown in the floor section.

It is also an acceptable practice to install the insulation at the bottom of the cavity with a kraft facing type vapor retarder on the bottom and in substantial contact with the gypsum board ceiling as shown in Figure 25B. In this case the vapor retarder function is provided by the subfloor sheathing and the kraft facing type vapor retarder on the batt should not cause moisture problems under typical climate conditions. In this application the kraft facing is typically stapled to the framing to hold the batts in place until the gypsum board ceiling is installed. An advantage of this practice is it keeps water supply pipes, hydronic heating pipes and air ducts in conditioned space, which may be preferred in extreme climates. When using this practice it is important to air-seal and insulate the band joist so the insulation does not have a gap between the ceiling and the wall.

Garage Walls

The wall between the living space and the garage shall be insulated to the same R-value as the exterior walls per local building codes. The vapor retarder should be installed in accordance with the vapor retarder guidance on page 13. When insulating the exterior walls of the garage with kraft faced batts, the batts should be installed with the kraft facing on the inside of the garage and unless it is a flame-retardant facing it must be covered with drywall or other suitable material. (See Figure 25.)

Insulating Around Obstacles

General

It is difficult to describe every situation that will be encountered by the insulation installer. In general, however, the installer should be guided by the need to reduce heat flow around or through obstructions and to protect mechanical systems.

Electrical

Junction boxes for wall switches and convenience outlets at outside walls should be insulated between the rear of the box and the sheathing. Place insulation behind the junction box and cut insulation to fit snugly around it. (See Figure 26.)

Where electrical wiring passes through a stud cavity and is located close to the inside wall surface, insulation should be pressed behind the wiring. When the wiring is in the center of the cavity, either a shallow cut in the insulation may be used to allow the wiring to pass through the insulation or it may be split lengthwise and the wiring sandwiched within. (See Figure 27 A and B.)

Figure 26

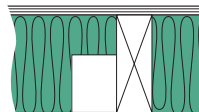
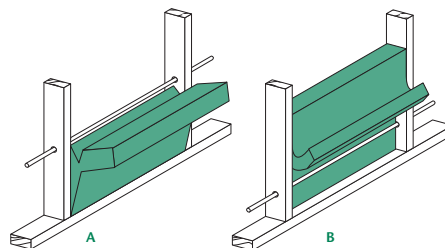

Figure 27



The National Electrical Code contains the following recessed lighting fixture requirement: "Thermal insulation shall not be installed within 3 inches of the recessed fixture enclosure, wiring compartment or ballast and shall not be so installed above the fixture as to entrap heat and prevent the free circulation of air unless the fixture is otherwise approved for the purpose." The requirements of the NEC must be followed.

Plumbing

To have the optimum thermal performance of insulation in the building envelope, it is important to minimize obstructions such as plumbing vent pipes and air ducts (see below). Additionally, placing plumbing pipes that contain standing water in the building envelope should be avoided when possible. These include waste traps and water supply lines. When it is necessary to locate these items within the building envelope, the insulation should be installed in contact with the obstruction to prevent excessive voids. If the insulation has a kraft type vapor retarder, it should be placed in substantial contact with the gypsum board. (See Figure 28.)

Figure 28

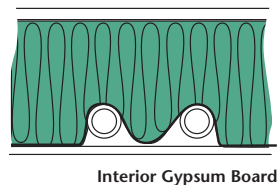

Air Ducts

Air ducts in an unconditioned space must be insulated. Insulated air ducts contribute to the home's overall indoor environment by delivering heated and cooled air at design temperatures and absorbing noise generated by central air conditioning equipment, air rush and cross-talk. In addition, insulated air ducts control the heat loss or gain through the air duct walls.

If an air duct runs through an unconditioned space such as an attic or a side wall, it should either insulated with duct wrap or batt insulation should be applied between the duct and the exterior wall sheathing.

Openings Through Building Sections

Where pipes, wiring, or ductwork penetrate a building section, any openings should be sealed to prevent air infiltration.

Vapor Retarders

A vapor retarder is defined by *ASTM Standard C 755* as a material or system that adequately retards the transmission of water vapor under specified conditions. The permeance of an adequate retarder for residential construction will not exceed 1 perm. A perm rating is a measure of the diffusion of water vapor through a material. Vapor diffusion accounts for only a small amount of the total moisture in a building. Therefore, other means should be utilized to reduce water vapor migration due to air infiltration.

An air retarder is different from a vapor retarder in that it blocks only air and liquid water, not water vapor. House wraps are one form of an air retarder. Typical exterior house wraps are not vapor retarders.

What Does a Vapor Retarder Do?

A vapor retarder slows the rate of water vapor diffusion but does not totally prevent its movement. Building occupants, certain appliances, and plumbing equipment generate moisture that is carried in the air as vapor. As water vapor moves from a warm interior through construction materials to a cooler surface, the water vapor may condense as liquid water that can damage the building. This is why vapor retarders are installed in buildings.

Types of Vapor Retarders

Any material that has a rating of 1 perm or less is considered to be a vapor retarder. The table below shows the perm rating of some common building materials that are consistent with ASHRAE Handbook of Fundamentals and other industry sources.

Vapor Retarders

Permeance¹

Kraft thermal insulation facing (asphalt laminated)	1 ²
Foil thermal insulation facing	0.5 ²
Saturated and coated rolled roofing	0.05
Paint (2 coats)	0.3 to 3 ⁴
Polyamid, 2 mil (variable permeability membrane)	1 to 20 ²
Polyethylene, 4 mil	0.08
Polyethylene, 6 mil	0.06
Vapor retarder paint (1 coat)	0.6 to 0.9 ³

Not Vapor Retarders

Perm Rating

Olefin, spunbond high density fiber (housewrap)	94 ²
Plaster (3/4" thick) on wood lath	11 ⁵
Gypsum wall board (3/8")	50 ⁶

Notes:

1. Values from 2009 ASHRAE Fundamentals handbook, unless otherwise noted.
2. Value supplied by manufacturer.
3. Value from Rodale Products Testing Laboratory.
4. Perm ratings for specific paints should be verified by independent testing using ASTM E-96A or equivalent TAPPI test standards.
5. Wet cup method.
6. Other than wet or dry cup method.

When is a Vapor Retarder Required?

The latest research on moisture performance of walls and vapor retarders has brought a greater understanding of how moisture moves through walls and where vapor retarders or needed. This research has significantly changed the vapor retarder requirements in the building codes. The 2009 editions of the International Code Council building codes are summarized below.

The International Residential Code defines vapor retarders as Class I, II or III based on how permeable they are to water vapor, the lower the permeability - the less water vapor that will pass through the vapor retarder.

- Class I - Very low permeability vapor retarders - rated at 0.1 perms or less. Sheet polyethylene (visqueen) or unperforated aluminum foil (FSK) are Class I vapor retarders.
- Class II - Low permeability vapor retarders - rated greater than 0.1 perms and less than or equal to 1.0 perms. The kraft facing on batts qualify as a Class II vapor retarder.

- Class III - Medium permeability vapor retarders - rated greater than 1 perm and less than or equal to 10 perms. Latex or enamel paint qualify as Class III vapor retarders.

Vapor Retarders in Cold Climate Zones (5, 6, 7 and Marine 4)

The International Residential Code requires either a Class I or II vapor retarder on the interior side of frame walls in climate zones: 5, 6, 7, 8 and marine 4 - refer to the climate zone map on page 16. A vapor retarder is not required for basement walls or on any portion of the wall that is below ground, or on walls made of materials that can't be damaged by moisture or its freezing.

Class III vapor retarders can be used on the interior side of the wall in the following climate zones when any one of the conditions in the table below apply:

Climate Zone

1, 2, 3 and 4	All wall assemblies
Marine 4	Vented cladding* over OSB Vented cladding* over plywood Vented cladding* over fiberboard Vented cladding* over gypsum Insulated sheathing with R-value ≥ 2.5 over 2x4 wall Insulated sheathing with R-value ≥ 3.75 over 2x6 wall
5	Vented cladding* over OSB Vented cladding* over plywood Vented cladding* over fiberboard Vented cladding* over gypsum Insulated sheathing with R-value ≥ 5 over 2x4 wall Insulated sheathing with R-value ≥ 7.5 over 2x6 wall
6	Vented cladding* over fiberboard Vented cladding* over gypsum Insulated sheathing with R-value ≥ 7.5 over 2x4 wall Insulated sheathing with R-value ≥ 11.25 over 2x6 wall
7 & 8	Insulated sheathing with R-value ≥ 10 over 2x4 wall Insulated sheathing with R-value ≥ 15 over 2x6 wall

* Vented Claddings include vinyl lap or horizontal aluminum siding installed over a weather resistive barrier, typically housewrap or 15 lb. building paper. Or Brick veneer with a minimum of space of 1" between the brick and the weather resistive barrier.

Vapor Retarders in Warm Climate Zones 1, 2, 3 and 4

The International Residential Code does not require or prohibit the use of vapor retarders in climate zones 1, 2, 3 and 4. NAIMA recommends using either a Class II or III vapor retarder in these warmer climate zones and not using Class I (very low perm) vapor retarders. Kraft-faced batts can be installed in all climate zones.

In the warmer climate zones installing vapor retarder with a very low perm rating on the interior of a wall assembly can lead to moisture problems. Even vinyl wall paper, which has a low perm rating, can induce moisture problems in warm humid climates where hot moist conditions tend to drive moisture into the wall from the outside of the building.

In very warm humid climates if a vapor retarder is used, NAIMA recommends installing it to the exterior side of the wall.

Cautions

Always follow these rules when working with vapor-retarder-faced insulation.

- Many standard insulation facings will burn and must not be left exposed in an occupied space. Combustible facings must be covered with gypsum board or another code-approved interior finish. Use only flame-resistant facings for exposed applications such as garages, storage rooms, utility rooms and laundries. To comply with codes, interior finish materials must have flame spread ratings of 200 or less. NAIMA recommends that vapor retarders not rated to be exposed also be covered in areas not ordinarily occupied but accessible for service work. Gypsum board is commonly used. NAIMA recommends that all combustible vapor retarders should bear printed statements that the vapor retarder is flammable and should not be left exposed and special care must be taken to keep open flame and other sources of heat away from the facing.
- Batts and rolls may be installed one on top of the other in ceilings where there is adequate space. In most cases, only the bottom layer should have a vapor retarder, which should face down toward the space that is warm in winter. Additional layers of insulation should be unfaced. If unfaced insulation is not available, use the faced type but remove the facing completely before installation.
- When the ICC codes (International Residential, Building or Energy Conservation Code) require a vapor retarder, batts which are inset stapled meet that requirement. A copy of the ICC code interpretation is available from NAIMA upon request.
- Repair small tears and gaps in the vapor retarder if desired by using duct tape or polyvinyl tape. However taping vapor retarder facings is not standard practice as small tears and gaps are not expected to cause moisture issues.
- Care should be taken not to staple into electrical wiring when installing faced insulation or separate vapor retarders.
- When kraft faced batts are used to meet Class II vapor retarder requirements, an additional polyethylene facing is not required or recommended in any instance.

Other Vapor Retarder Materials

Separate vapor retarders are used in some constructions. When required, a separate vapor retarder should be installed on the warm-in-winter side of the framing. (In hot, humid climates, vapor retarders are sometimes omitted or installed outside the insulation.) Four-mil or thicker polyethylene sheeting, available in rolls, is typically placed horizontally and stapled to the face of the framing. If more than one sheet of polyethylene is required, overlap the sheets across two framing members. Foil-backed gypsum board is also an effective vapor retarder.

Ground Covers

Where the floor of a crawl space is soil or gravel, a vapor retarder should be installed covering the ground to prevent moisture from entering the crawlspace. The vapor retarder should be a minimum of 6 mil polyethylene sheeting with the joints lapped at least 6-inches and sealed. The edges should extend a minimum of 6 inches up the wall and be sealed to the wall using adhesive caulking. A 55-pound-or-heavier asphalt roll roofing, laid on the floor and up the walls approximately 6 inches can also be used. The joints should lap at least 12 inches and be sealed.

Final Inspection

Once the insulation job is complete, perform a final visual check to make sure the insulation is installed correctly so that it will meet the code and perform as intended for the life of the home. (See Appendix for an easy 25-point inspection checklist.)

Clothing and Equipment

Clothing

When installing fiber glass insulation, NAIMA recommends that you:

- Wear a long sleeved shirt loose at the neck and wrists, long pants, gloves and cap.
- Wear eye protection (safety goggles, safety glasses or a face shield or a combination of these, as appropriate).
- Wear a NIOSH-certified disposable dust mask (N95 series.) For more detailed information on recommended work practices, contact NAIMA or the individual manufacturer.

Equipment

For cutting insulation the best knife has been found to be one with a serrated blade. Blades should be replaced periodically as they tend to dull during use. Other equipment may be preferred by the installer.

What NAIMA Tells Consumers

In publications distributed to homeowners, NAIMA advises them on selecting contractors and dealing with their application crews. Here's an excerpt from the booklet *"How to Save Money by Insulating Your Home."*

If you prefer to hire an insulation contractor, you can find one by:

- Asking your utility company for suggestions.
- Consulting friends and neighbors.
- Looking in the phone book "Yellow Pages" under "Insulation Contractors-Cold & Heat" or a similar heading. Remember that a contractor has the special skills needed to insulate sidewalls as well as to do an expert job of insulating ceilings and floors.
- Contacting the Insulation Contractors Association of America (ICAA) at www.insulate.org for a list of certified contractors in your area.

The next step is to call in two or three contractors to quote your job. You should judge contractors' reliability as well as their prices. Here are some suggestions:

- Check a contractor with the local Better Business Bureau (also listed in the phone book). Or ask your bank to get a report on credit ratings.
- Ask contractors for references, including other homeowners for whom they have done work. Check them out.
- Give all the contractors exactly the same description of what you want done. For example, say, "I want to add R-19 to my attic floor," then stay with that specification and that way of saying it. Don't be satisfied if a contractor says, "Okay, I'll add 6 inches." Not all brands of insulation have the same R-value per inch. Six inches of one brand might not have the same R-value as 6 inches of another. Stick with R-values. If contractors won't deal with you in R-value language, don't deal with them.
- If a contractor is going to blow insulation in your attic, how can you tell if you're getting the R-value you've requested? First of all, make sure the written contract states R-value, the minimum thickness and the number of bags of insulation to be used to achieve the R-value. In addition, you can check the bag label yourself.
- Ask contractors how they pay installers, by the number of square feet they install or by the hour. If they pay them by square footage, they might do a hasty job on your house just so they can get on to the next one.
- Ask contractors about the insurance they carry. Do they have insurance to protect their own workers if they are injured? Are you covered if a worker damages your house?
- At the contract signing ask for current copies of insurance and licensing documents.

Material Specifications

Assurance of insulation material quality is extremely important to the safety and effectiveness of installed insulation. NAIMA recommends the use of insulation that meets the requirements of the current edition of *ASTM C 665 Standard Specification for Mineral Fiber Blanket Thermal Insulation*.

Thermal Recommendations and Codes

The Department of Energy recently released its new R-value recommendations for new and existing homes. (See Figure 29, following page.)

The insulation recommendations for attics, cathedral ceilings, walls and floors have been increased overall and generally exceed those required by most building codes. The new recommendations are based on comparing future energy savings to the current cost of installing insulation.

Figure 29

Department of Energy R-Value Recommendations

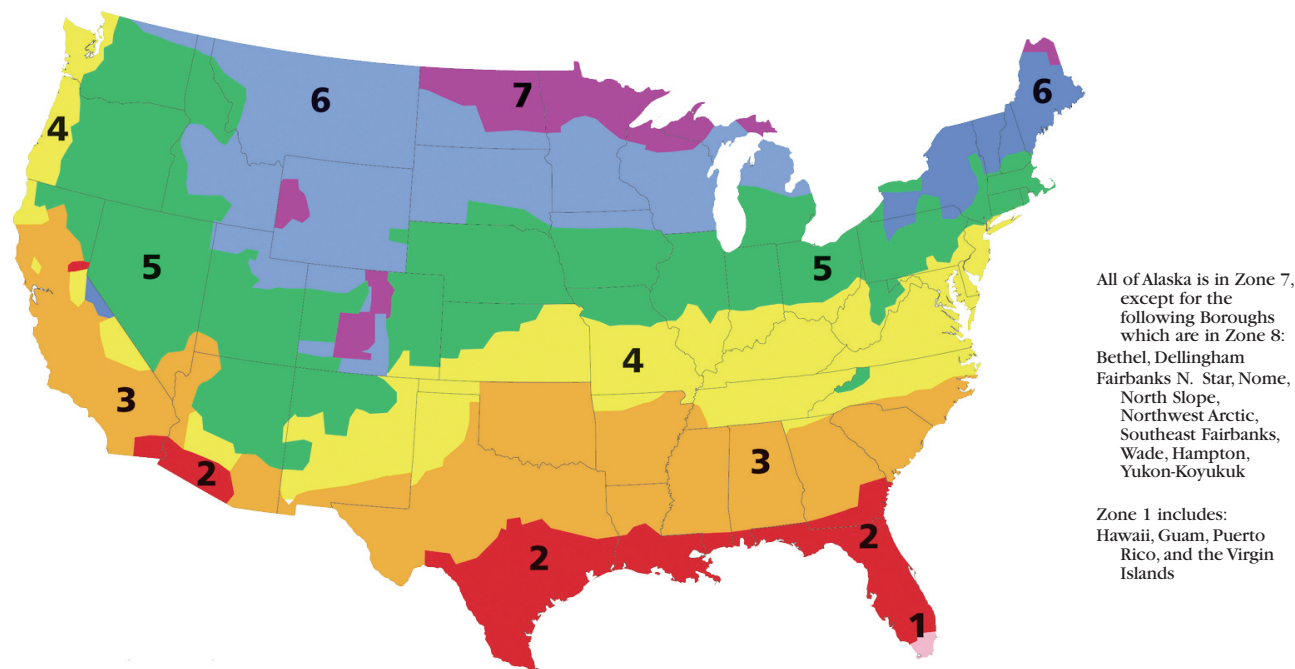

New Wood-Framed Houses

Zone	Heating System	Attic	Cathedral Ceiling	Wall		Floor
				Cavity	Insulation Sheathing	
1	All	R30 to R49	R22 to R38	R13 to R15	None	R13
2	Gas, oil, heat pump	R30 to R60	R22 to R38	R13 to R15	None	R13
	Electric furnace					R19 to R25
3	Gas, oil, heat pump	R30 to R60	R22 to R38	R13 to R15	None	R25
	Electric furnace				R2.5 to R5	
4	Gas, oil, heat pump	R38 to R60	R30 to R38	R13 to R15	R2.5 to R6	R25 to R30
	Electric furnace				R5 to R6	
5	Gas, oil, heat pump	R38 to R60	R30 to R38	R13 to R15	R2.5 to R6	R25 to R30
	Electric furnace				R5 to R6	
6	All	R49 to R60	R30 to R38	R13 to R15	R5 to R6	R25 to R30
7	All	R49 to R60	R30 to R38	R13 to R15	R5 to R6	R25 to R30
8	All	R49 to R60	R30 to R38	R13 to R15	R5 to R6	R25 to R30

Existing Wood-Framed Houses

Zone	Add Insulation to Attic		Floor
	Uninsulated Attic	Existing 3 to 4 inches of Insulation	
1	R30 to R49	R25 to R30	R13
2	R30 to R60	R25 to R38	R13 to R19
3	R30 to R60	R25 to R38	R19 to R25
4	R30 to R60	R38	R25 to R30
5-8	R49 to R60	R38 to R49	R25 to R30

Wall Insulation - Whenever exterior siding is removed on an:

Uninsulated wood-frame wall:

- Drill holes in the sheathing and blow insulation into the empty wall cavity before installing the new siding
- Insulative sheathing may be used as necessary to meet R-value requirements

Insulated wood-frame wall:

- For Zones 4-8, add R5 insulative sheathing before installing the new siding

Reference: Department of Energy/CE-0180 2008, Insulation Fact Sheet

Appendix: 25 Check Points for Inspecting Insulation Jobs

Wall Areas

1. Cavity Fill. The batts or loose-fill should fill all standard and narrow cavities completely: no gaps top or bottom.
2. Electrical Wiring. Insulation should be split or cut to fit around wiring.
3. Electrical Boxes. Batts should be cut to fit around electrical boxes with a piece placed behind each box.
4. Plumbing. Insulation should be placed between the outside wall and the pipes. If kraft facing is used, it should be in substantial contact with the gypsum board.
5. R-value. The R-value should be marked visibly on the insulation, faced or unfaced. The R-value should meet or exceed the minimum code requirements.
6. Fitting. Batts should friction fit snugly in the cavity. Faced batts can be inset or faced stapled as needed. If inset stapled, batts should not be overly compressed.

Vapor Retarder, Requirements, Placement, and Repair

For a complete checklist see pages 13-14 of this guide.

7. Requirements: When required, appropriate vapor retarder materials may include kraft facing, continuous polyethylene sheeting, vapor retarder paints and "smart" vapor retarders. (Note: Polyethylene should only be used in very cold climates.)
9. Integrity: Taping vapor retarder facings is not standard practice. Small tears and gaps are not expected to cause moisture issues but can be repaired if desired.
10. Bay Window. The outside wall, extended floor, and ceiling should be insulated.
11. Window and Door Areas. Spaces around windows and doors should be filled with insulation or caulked. Do not overstuff.
12. Band Joists. Insulation with a nonflammable facing should be used for band joists.

Ceilings and Floors

13. Cantilevered Floors. These should be insulated at the floor R-value requirements.
14. Attic Openings. The attic opening should be insulated with insulated covers or a piece of batt insulation at the same R-value as the attic requirements and secured in place.
15. Attic Cards. A completed attic card may be placed near the attic opening when blown insulation is installed.
16. Attic Rulers. When blown insulation is used, it is good practice to install attic rulers, one for every 300 square feet of attic area. The installed thickness of blown insulation should not be less than the minimum settled thickness on the attic card.

17. Eave Baffles. Baffles should be installed on eaves with vents.

18. Knee Walls. Knee walls should be insulated at wall R-value requirements. Insulation should be supported with an appropriately fire-rated backing on the exterior side.

General

19. Air Infiltration. All insulation requires proper air sealing or the installation of a rated air barrier. All air paths should be sealed using caulk, tape, air barriers or other air sealing measures. (For more guidance on air infiltration refer to the ICC Air Barrier and Insulation Inspection Component Criteria on page 18.)

20. Wet-Installed Insulation. Any insulation installed with water should be thoroughly dried before covering with gypsum board. Humid climates may require longer drying times.

21. Combustible Sources. Keep all insulation at least 3 inches away from combustible sources such as chimneys, non-IC fixtures, and heated flue pipes.

22. Unheated Rooms. The walls, ceilings, and floors between living space and unheated areas should be insulated.

23. Shower/Tub Enclosures. Insulation should be installed between tub enclosures and outside walls.

24. Exposed Facings. Unfaced or special faced insulation products, such as FSK-25 insulation, are acceptable for exposed applications. In an exposed application, it is not acceptable to place a flame spread rated facing, such as foil cap sheet, over a non-rated facing, such as kraft paper or standard foil.

25. Wet Insulation - Incidental wetting during installation is not usually a problem. Fiber glass batt insulation wetted with clean water can usually be dried and reused. All saturated loose-fill insulation should be replaced.

"25 Checkpoints for Inspecting Insulation Jobs" is intended to provide useful guidance on how to improve the quality of the installation of insulation products. Use of this guide does not ensure or guarantee compliance with building codes, acceptance by building inspectors, or compliance with any other type of governmental or building requirements. Use of these guidelines does not guarantee you any specific level of energy savings or dollar savings. Use of this guidance does not guarantee that mistakes have not been made in the installation process. NAIMA encourages consultation with individual manufacturer's guidance on proper installation of their specific products.

ICC Air Barrier And Insulation Inspection Component Criteria

Air barrier and thermal barrier

Exterior thermal envelope contains a continuous air barrier

Exterior thermal insulation is installed in substantial contact and continuous alignment with building envelope air barrier.

Breaks or joints in the air barrier are filled or repaired.

Air permeable insulation is not used as a sealing material.

Ceiling / attic

Air barrier in any dropped ceiling / soffit is substantially aligned with insulation and any gaps are sealed.

Attic access (except unvented attic), knee wall door, or drop down stair is sealed.

Walls

Corners and headers are insulated.

Junction of foundation and sill plate is sealed.

Windows and doors

Space between window/door jambs and framing is sealed.

Rim joists

Rim joists are insulated and include an air barrier.

Floors (including above garage and cantilevered floors)

Insulation is installed to maintain permanent contact with underside of subfloor decking.

Air barrier is installed at any exposed edge of insulation.

Crawlspace walls

Insulation is permanently attached to walls.

Exposed earth in unvented crawlspaces is covered with class I vapor retarder with overlapping joints taped.

Shafts, penetrations

Duct shafts, utility penetrations, knee walls, and flue shafts opening to exterior or unconditioned space are sealed.

Narrow cavities

Batts in narrow cavities are cut to fit, or narrow cavities are filled by sprayed/blown insulation.

Garage separation

Air sealing is provided between the garage and conditioned spaces.

Recessed lighting

Recessed light fixtures are airtight, IC rated, and sealed to drywall.

Exception--fixtures in conditioned space.

Plumbing and Wiring

Insulation is placed between outside and pipes.

Batt insulation is cut to fit around wiring and plumbing, or sprayed/blown insulation extends behind piping and wiring.

Shower / tub on exterior wall

Showers and tubs on exterior walls have insulation and an air barrier separating them from the exterior wall.

Electrical / phone box on exterior walls

Air barrier extends behind boxes or an air sealed type boxes are installed.

Common wall

Air barrier is installed in common wall between dwelling units.

HVAC register boots

HVAC register boots that penetrate building envelope are sealed to subfloor or drywall.

Fireplace

Fireplace walls include an air barrier.

These checkpoints are intended to provide useful guidance on how to improve the quality of the installation of insulation products. They do not ensure or guarantee compliance with building codes, acceptance by building inspectors, or compliance with any other type of governmental or building requirements. Use of these guidelines does not guarantee you any specific level of energy savings or dollar savings. Use of this guidance does not guarantee that mistakes have not been made in the installation process. NAIMA encourages consultation with individual manufacturer's guidance on proper installation of their specific products.



About NAIMA

NAIMA is the association for North American manufacturers of fiber glass, rock wool, and slag wool insulation products. Its role is to promote energy efficiency and environmental preservation through the use of fiber glass, rock wool, and slag wool insulation, and to encourage the safe production and use of these materials.

NAIMA, continuing its members' commitment to safety has established a renewed Product Stewardship Program, which embodies the components of the earlier OSHA-NAIMA Health and Safety Partnership Program (HSPP). The HSPP was a comprehensive eight-year partnership with OSHA, which NAIMA completed in May 2007, and now NAIMA incorporates these safe work practices into NAIMA's Product Stewardship Program.

NAIMA Residential and Commercial Insulation Committee:

CertainTeed Corporation
P.O. Box 860
Valley Forge, PA 19482
800-233-8990
www.certainteed.com

Owens Corning
One Owens Corning Parkway
Toledo, OH 43659
800-GET-PINK
www.owenscorning.com

Johns Manville
P.O. Box 5108
Denver, CO 80217
800-654-3103
www.jm.com

Roxul Inc.
551 Harrop Drive,
Milton, Ontario, Canada L9T 3H3
800-265-6878
www.roxul.com

Knauf Insulation
One Knauf Drive
Shelbyville, IN 46176
800-825-4434
www.knaufinsulation.us

For additional information contact:

NAIMA
44 Canal Center Plaza
Suite 310
Alexandria, Virginia 22314
Phone: 703-684-0084
Fax: 703-684-0427
www.naima.org