



# CREATING DISTINCTION



For customer service inquiries, call us Monday through Friday, from 6 a.m. to 5 p.m. (PT), at **800.JELD-WEN**. Find installation and maintenance instructions at [www.jeld-wen.com/resources](http://www.jeld-wen.com/resources).



Style. Craftsmanship. Individuality. All these elements are necessary to create a distinctive home. You'll also find these qualities in Custom Wood windows and patio doors from JELD-WEN. They're made by expert artisans from AuraLast® wood for lasting visual appeal. That's reliability made beautiful.



### Certifications

Our windows and patio doors have earned Hallmark certification from the Window and Door Manufacturers Association (WDMA), which is considered a mark of excellence among architects, contractors and other specifiers. It is accepted industry-wide.

### Table of Contents

AuraLast® wood.....	4	Double-Hung windows.....	24
Materials and components .....	5	Horizontal Gliding windows .....	26
Clad finishes .....	6	Radius and Geometric windows .....	28
Aesthetic options .....	8	Swinging Patio doors.....	32
Divided lites.....	12	Gliding Patio doors.....	34
Glass types .....	14	Sidelights and Transoms.....	36
Special products and applications .....	16	Specifications.....	38
Awning windows.....	20	Warranty .....	286
Casement windows .....	22	About JELD-WEN .....	287

## THE ELEMENTS OF BEAUTY

### AuraLast® wood *(patent pending)*

All Custom Wood windows and patio doors feature solid pine AuraLast wood construction for superior protection from wood decay, water saturation and termites. This protection is supported by our exclusive 20-year warranty.

**AuraLast wood** (shown in green) provides virtually 100 percent penetration of the protective ingredients—from the surface to the core. This means nail and screw holes or other installation methods cannot compromise the integrity of AuraLast wood.

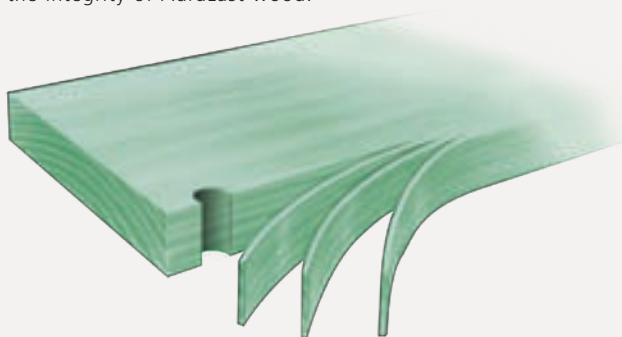

In contrast, other manufacturers use **dip-treated wood** (shown in red), which is protected on the surface only. This means the treatment's effectiveness will be compromised when the surface is broken during installation.

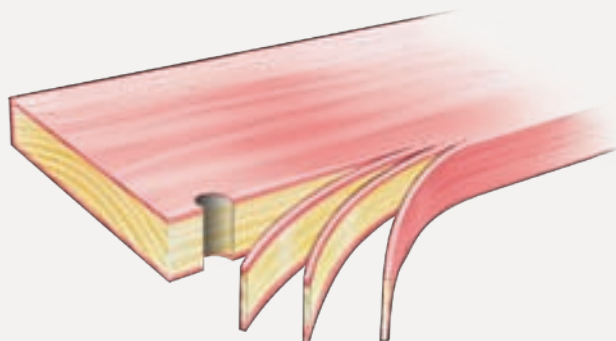

*Colors are used for illustration purposes only;  
AuraLast wood has a clear pine color.*



We offer the industry's only 20-year warranty against wood decay and termite infestation.



### Clad-Wood exteriors

For steadfast protection from the elements, select our clad-wood windows and patio doors. They feature durable metal cladding, so they're appropriate for almost every climate and require minimal maintenance. In addition to delivering enhanced performance, clad-wood exteriors offer plenty of design flexibility. They're available in a range of clad colors to complement any home (see the following page for details). These frames are now made with an integral nailing fin for installations that are faster, easier and more secure. As an integral part of the frame, it also offers increased strength and stability.

Integral nailing fin



### Wood exteriors

With wood exteriors, you gain greater design freedom, because they can be painted any color you desire. They come with factory-applied primer that helps paint adhere to the wood. What's more, AuraLast wood significantly reduces the amount the wood swells and contracts, so less maintenance is required. Optional natural (unprimed) wood exteriors are also available in fir, mahogany or solid pine AuraLast wood.

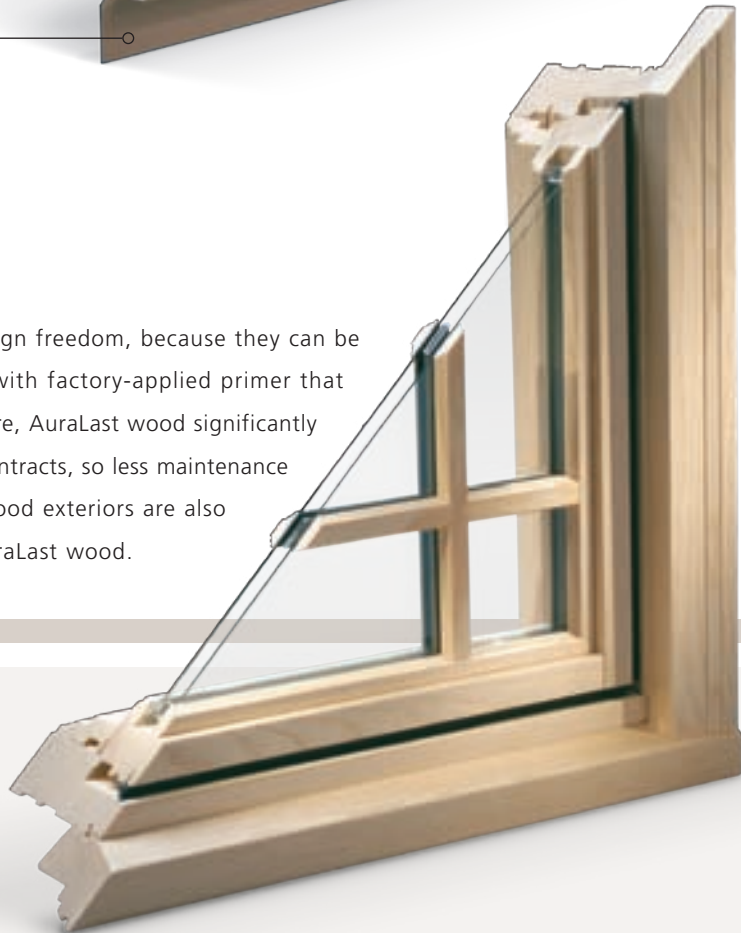

# ARTFUL EXTERIORS

Clad exterior with Arctic Silver finish



## 41 metal clad colors and custom color matching

We've created a wide array of enduring metal clad color finishes for our windows and patio doors. This vast assortment includes colors that were created in response to our customers' design preferences. We also provide custom color matching for a truly personalized look.

All Custom Wood metal clad finishes will stay truer and brighter than other finish options. This is because they feature a commercial-grade 70% Kynar 500® resin system, which resists fading and chalking (finish degradation caused by ultraviolet exposure). In fact, Kynar 500 is so strong it outperforms silicone polyester, urethane, powder and acrylic coatings. Our warranty guarantees that the finish won't chalk or fade for 20 years, even in coastal environments.\* That's a benefit you'll find only from JELD-WEN.



## 41 exterior metal clad colors with a 70% Kynar 500® finish

Brilliant White	French Vanilla	Desert Sand	Bone White	White	Cambridge White	Ivory	Mocha Cream	Champagne
Heirloom White	Smoke	Arctic Silver	Dark Chocolate	Mesa Red	Pueblo Tan	Haverstraw	Garnet	Rosewood
Scarlet Haze	Clover Mist	Redwood	Hartford Green	Hunter Green	Dark Ivy	Ivy	Mosaic Green	Sea Foam
Teal	Black Emerald	Chestnut Bronze	Black Licorice	Sage Brown	Buckskin	Bronze	Dark Buckskin	Capri Blue
Cascade	Deep Summer	Hudson Blue	Liberty Blue	Wedgewood				

*Actual colors may vary from the samples displayed. Please visit your JELD-WEN dealer for actual samples.*



### Copper cladding

Enjoy a dynamic look with our copper cladding options. Copper cladding will change in appearance over time, based on region, exposure to moisture, and interaction with various elements in the atmosphere. It's available on the window sash component or patio door panel only, so you can select a contrasting or complementary metal clad color for the frame; or choose a wood frame you can paint any color. Along with Bright Copper cladding, we offer Speckled Patina Copper and Hand-Rubbed Patina Copper for the look of aged copper without the wait. You may also choose simulated divided lites (SDL) with 1" putty bars for our copper-clad products.

### Copper cladding

1. Speckled Patina Copper
2. Hand-Rubbed Patina Copper
3. Bright Copper



# EXTRAORDINARY ACCENTS

Swinging patio door handle set with Brushed Chrome finish

Multipoint handle set



Single-point gliding patio door handle with Antique Brass finish

## Hardware finishes

We offer a variety of finishes for our windows and patio doors (see below).

E-Gard® hardware is available for superior corrosion protection (handle sets for casement and awning windows only), or you can select optional coastal hardware that stands up to saltwater and other harsh coastal conditions. In addition, we offer electric operators to operate single windows or entire groups of windows (available for awning windows only).

### Available finishes for windows



### Available finishes for patio doors

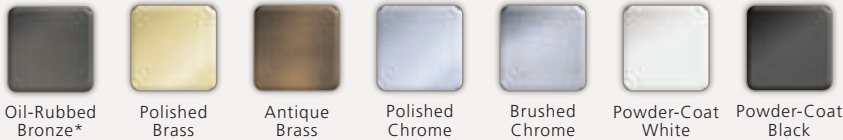

Actual colors may vary from the samples displayed.  
\*Oil-Rubbed Bronze will change in appearance over time.



Nesting handle with Chestnut Bronze finish

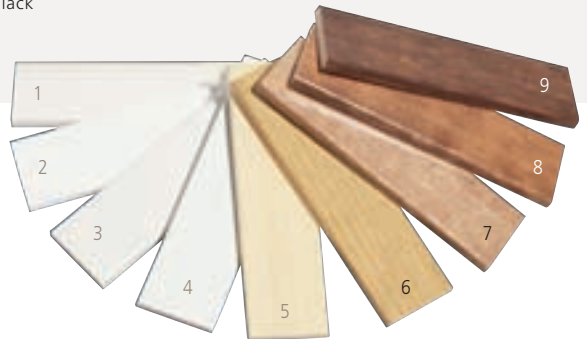

Colors shown may not match final finish.

## Prefinished pine interiors

Our prefinished pine interiors are available for all our windows and patio doors. These options include four acrylic colors, four stain colors and a clear lacquer top coat.

- |                   |                   |                  |              |
|-------------------|-------------------|------------------|--------------|
| 1. Moderate White | 3. Natural Choice | 5. Clear Lacquer | 7. Cherry    |
| 2. Extra White    | 4. Pure White     | 6. Wheat         | 8. Fruitwood |
|                   |                   |                  | 9. Cordovan  |

## Interior trim

We offer interior trim for all our products. Trim options include straight lineal lengths, as well as curved trim for the radius portion of our radius windows and patio doors. This trim is available in five standard patterns.



WM316

WM346

WM356

WM366

WM445





### Exterior trim

Our factory-applied exterior trim is a beautiful way to frame our windows and patio doors. We offer Adams and flat casings or brickmould for either primed wood or clad-wood exteriors. Also, Manchester trim is available for clad-wood exteriors; backband is available for wood exteriors. Other types of trim are available upon request.

#### Wood Exterior Trim



Adams



Brickmould



Flat (3-1/2", 4-1/2", 5-1/2")



Backband

#### Clad Exterior Trim

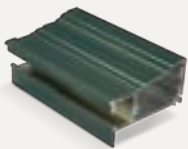

Adams



Brickmould

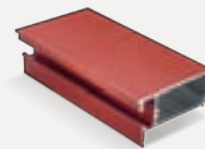

Flat

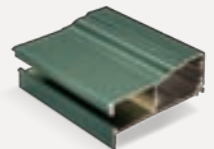

Manchester

### BetterVue™ screens

These screens\* are designed to keep more insects outside, while letting more natural light inside. They feature fine, Black fiberglass mesh with a light gloss finish. BetterVue insect screens are now standard for awning, casement, double-hung and horizontal gliding windows.



Scene looking through BetterVue insect screen



Scene looking through regular fiberglass insect screen



### Wood screen frames

For greater beauty and design consistency, select optional wood insect screen frames for casement, horizontal gliding, double-hung and awning windows. They're available in our four interior wood species. The mesh consists of durable Charcoal fiberglass screen cloth that resists dents.



## Phantom Screens® Technology

Our windows are now available with Phantom Screens Technology.\* This feature includes convenient, retractable insect screens that fully reveal beautiful exterior views. They're made to be durable, secure and easy to use, and they'll integrate seamlessly with the rest of the window. In fact, they're available in our four interior wood species. Screens for double-hung windows also have a removable track that allows sash to tilt in for easy cleaning.

*Not available for horizontal gliding or radius and geometric windows.*



## Interior and exterior wood species

Increase a home's sense of visual harmony by choosing optional interior and exterior wood species to coordinate with trim, cabinetry and furnishings. In addition to standard pine, we offer optional mahogany with prominent growth ring patterns and a reddish hue; knotty alder, which features a fairly straight grain that blends well with cherry, maple or birch grain and knotty patterns; and vertical-grain Douglas fir with exceptional stain and finish consistency. These wood species are available for the interior of our metal-clad windows and patio doors; mahogany and Douglas fir are also available for the exterior of our primed wood windows and patio doors.



Mahogany  
*optional interior and exterior*



Vertical-Grain Douglas Fir  
*optional interior and exterior*



Knotty Alder  
*optional interior*



Pine AuraLast® Wood  
*standard*

# SPARKLING MOSAICS

Interior bars match interior wood species  
 Internal metal bars create a true divided lite look



## Simulated divided lites (SDL)

For the most authentic divided lite appearance, select our SDL option. It includes detailed interior wood bars, metal bars placed between the panes of insulating glass, and exterior metal bars that are permanently attached to the exterior glass with a 3M® very high bond (VHB) adhesive system. Bars are available in four widths: 7/8", 1-1/8", 1-3/8" and 2-5/16"; and two profiles: bead and putty (putty available in 7/8" and 1-1/8", or 1" copper only). Exterior metal bars come in our 41 clad colors; or you may choose primed metal bars, which may be painted any color you choose (available for windows and patio doors with wood exteriors only).

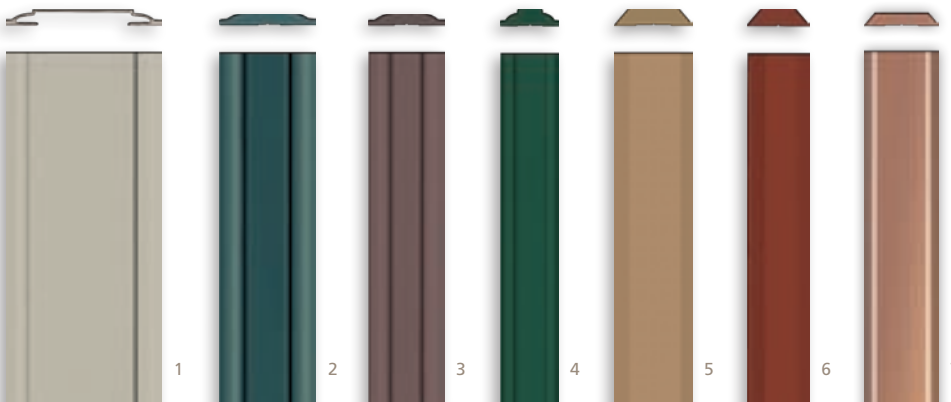

### Simulated Divided Lite Profiles

1. 2-5/16" bead
2. 1-3/8" bead
3. 1-1/8" bead
4. 7/8" bead
5. 1-1/8" putty
6. 7/8" putty
7. 1" copper putty\*

Exterior bars match clad color (or may be painted for wood exteriors)

Interior bars match interior wood species

## Precise simulated divided lites (PDL)

This option features wood exterior bars, wood interior bars and an internal metal shadow bar. Both interior and exterior bars are designed with identical widths and are permanently locked to the glass with VHB adhesive. Muntin bars are available in 3/4" and 1-1/2" sizes. PDLs are designed for wood exteriors only.

Exterior bars match exterior wood  
 Internal metal shadow bars offer the illusion of true divided lites



## Grilles between the glass (GBG)

Enjoy increased visual appeal and decreased maintenance with our grilles between the glass, which consist of a spacer bar placed between the panes of insulating glass. We offer 5/8" flat grilles, as well as 1" contour and 5/8" contour grilles. Our contour grilles are available with two-tone coloring (Brilliant White inside and Desert Sand outside or vice versa).

\*Available on copper-clad units only



### Full-surround wood grilles (FS)

Our full-surround wood grilles are a convenient way to achieve the look of divided lites. These grilles are positioned on the interior glass and can be removed for easy cleaning. They're available with 7/8", 1-1/8" or 1-3/8" grilles.



# CLEARLY RADIANT

## Tinted glass

This glass is ideal for climates with intense sunlight. It reduces glare and visible light transmittance, while also keeping homes more comfortable in warm weather. We offer Grey or Bronze tinted glass.



Grey tinted



Bronze tinted



## Textured glass

Add a distinctive touch to our wood windows and patio doors with textured glass. We offer a range of options, such as narrow reed and glue chip. For complete information, please contact your dealer.



Obscure



Spectrum Seedy



Glue Chip

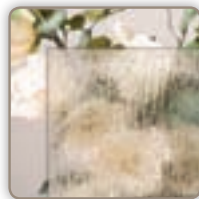

Rain



Narrow Reed



Sandblasted



## Neat™ glass

With this glass option you gain natural cleaning convenience. By harnessing the sun's UV rays (even when the sky is cloudy) to loosen dirt from the glass, rainwater can easily rinse away grime. No manual activation is required.

## Preserve® protective film

Preserve film comes standard on our Custom Wood window and patio door glass. It is factory-applied to both the interior and exterior surfaces of the glass. This means the glass surfaces will be reliably protected from debris and scratches that can occur during shipping and handling or at a construction site. So you won't need to spend extra time cleaning your new windows. What's more, it's easy to remove. Preserve film is not available with impact-resistant glass or single pane units.



### LoE<sup>3</sup>-366 insulating glass

High-performance LoE<sup>3</sup>-366 insulating glass lowers energy costs, helps homes stay cooler in the summer and warmer in the winter, prevents fading of interior furnishings, and reduces condensation. It also delivers greater visible light transmittance than tinted glass. LoE<sup>3</sup>-366 glass now comes standard on our windows and patio doors.

Many JELD-WEN® windows and patio doors with LoE<sup>3</sup>-366 or Low-E glass are also ENERGY STAR® qualified, which means they exceed the minimum energy efficiency criteria for the climate region you live in (by as much as 45 percent). For complete information please visit [www.jeld-wen.com](http://www.jeld-wen.com).



In warm weather, LoE<sup>3</sup>-366 glass reflects the sun's energy and reduces heat gain in the home.



In cold weather, LoE<sup>3</sup>-366 glass reduces the amount of heat lost by reflecting it back inside.



### Single pane and single pane with energy panel

Our single pane option offers good year-round performance in moderate climates, and our single pane with energy panel offers a basic layer of protection from the elements. The latter option features one pane of glass with another pane on the exterior.

### High-altitude insulating glass

This option prevents glass panes from bowing in higher elevations. It includes breather tubes (placed between the panes of insulating glass) to equalize the airspace pressure with the atmosphere. Argon gas is not available with high-altitude units.



### ImpactGard® protection

Custom Wood windows and patio doors are available with ImpactGard protection, which features glass that's engineered and tested to stand up to the strong impacts of windborne debris, as well as the harsh conditions inherent to coastal areas. With the industry's leading laminated glass technology, products with ImpactGard protection can withstand a nine-pound piece of lumber striking the glass head-on at approximately 34 miles per hour. Additionally, it significantly reduces sound transmission, blocks up to 95 percent of harmful UV rays, and offers superior forced-entry resistance.



When strong winds enter a home through a broken window or door, the increased pressure can lift the roof and push walls outward.



ImpactGard protection helps prevent this by resisting impacts from windborne debris.

## CRAFTSMANSHIP FOR EVERY OCCASION

Along with our wide array of styles and options, we offer Custom Wood windows and patio doors for unique projects. Whether you need an architecturally accurate bay window for a Victorian home you're renovating, or you want to include large-scale wood windows in your light commercial project, you'll discover we have all the products and options you need.



### Historic renovation

We know that renovating a historic home requires accuracy in every detail. That's why we create windows, patio doors and design options with different architectural styles in mind, including Victorian, Craftsman, Old World and Colonial. With this high level of architectural authenticity, our windows and patio doors are perfect for nearly any historic renovation project—even if the home must follow building codes designed to preserve its heritage.





### Epic® series

Our Epic series includes beautiful large-scale double-hung windows and swinging patio doors. Epic double-hung windows can be incorporated into new or existing rough openings that are up to 5'6" wide and 10'6" tall. Epic swinging patio doors feature 6-5/8" stiles and a 10-1/4" bottom rail to accommodate commercial hardware needs. Epic series windows and patio doors are ideal for new projects, yet they may also be used to increase the thermal efficiency of a historic building without sacrificing character or charm.



# WOOD AND CLAD-WOOD WINDOWS





#### ANATOMY OF A CUSTOM WOOD WINDOW

1. Head jamb
2. Lites
3. Grille
4. Glazing/  
Glass
5. Upper sash
6. Sash lock
7. Side jamb
8. Stile
9. Lower sash
10. Rail
11. Sill

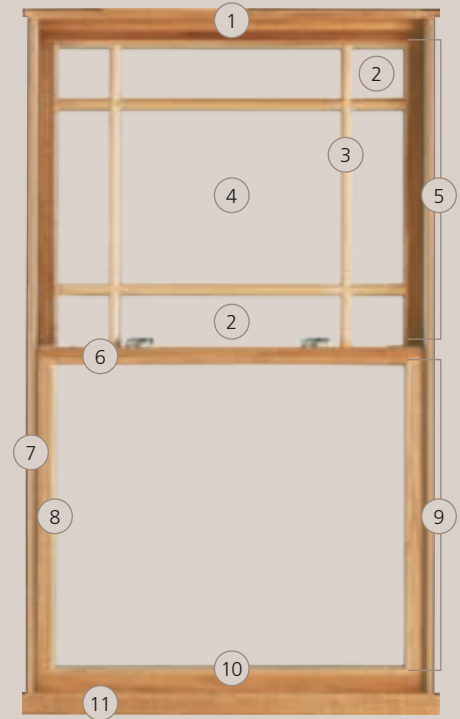

*The window frame consists of the head jamb, side jambs and sill.*

When you want windows that offer extraordinary artistry and consistent reliability, you need Custom Wood windows. Each one is sure to beautifully enhance your project.

## AWNING WINDOWS

These versatile windows are compatible with a variety of architectural styles. They're hinged at the top and open out from the bottom in an upward swing. Our awning windows can be opened to fractions of full venting or closed securely without shaking or rattling.



Exterior clad-wood



Interior mahogany



### Standard features

- Solid pine AuraLast® wood protects against wood decay, water saturation and termite infestation
- Mortise-and-tenon joints for maximum strength and durability
- Integral nailing fin for increased strength and easy installation
- Natural wood interiors are ready for staining or painting
- Sash thickness is 2-3/32" to increase visual warmth and appeal
- Factory-applied jamb extensions available in a variety of widths
- High-performance LoE<sup>3</sup>-366 insulating glass for greater energy efficiency
- Preserve® protective film
- Full weatherstrip system for added energy efficiency and comfort
- E-Gard® operator and single-action unison lock for easy, smooth operation
- Nesting folding handle
- Hardware available in Chestnut Bronze, White or Desert Sand
- BetterVue™ insect screens let in more light and keep more insects out\*

### Optional features

- Glass options include argon-filled Low-E, textured, tinted, Neat™, ImpactGard™ protection, single pane, single pane with energy panel, high-altitude insulating and tempered
- Hardware available in Oil-Rubbed Bronze\*\*, Polished Brass, Antique Brass, Brushed Chrome or Polished Chrome
- Coastal hardware for maximum corrosion resistance
- Extension arm operators or remote-controlled electric motors for special needs
- Divided lite options include simulated divided lites, full-surround wood grilles and grilles between the glass (see pages 12–13)
- Wood screen frames available in mahogany, alder, vertical-grain Douglas fir or pine
- Insect screens with Phantom Screens® Technology seamlessly integrate with the rest of the window

### Clad-wood exteriors: additional features

- 41 exterior clad colors with commercial-grade 70% Kynar 500® resin system (see page 6)
- Optional copper cladding in Bright Copper, Speckled Patina Copper or Hand-Rubbed Patina Copper
- Optional exterior trim: brickmould, 3-1/2" flat casing, Adams casing or Manchester casing
- Optional interior wood species: mahogany, alder or vertical-grain Douglas fir

### Wood exteriors: additional features

- Exterior is factory-primed and ready for painting
- Optional natural (no prime) pine, vertical-grain Douglas fir or mahogany exterior
- Optional factory-applied exterior trim: brickmould, backband, 3-1/2", 4-1/2", and 5-1/2" flat casing or Adams casing
- Optional precise simulated divided lites (see page 12)

*For complete specifications, see pages 39–60.*

*\*Insect screens are intended to allow air and light in, while keeping insects out. They are not intended to stop children from falling through an open door or window. For safety screens and other security devices, contact your local building supply retailer.*

*\*\*Oil-Rubbed Bronze will change in appearance over time.*

## CASEMENT WINDOWS

These stylish windows lend a sense of elegance to any home, and they deliver the most unobstructed viewing areas, structural integrity and ventilation of any operating window. Each one is hinged so the sash opens outward, to the right or left, in a swinging motion. For an especially charming appearance, select our French casement windows, which feature two sash that open outward without a center mullion and provide a clear opening. We also offer push out casement windows that operate simply with friction hinges and have an especially clean look.



Exterior clad-wood radius casement



Nesting handle (closed)



Interior pine radius casement with nesting handle (open)

### Standard features

- Solid pine Auralast® wood protects against wood decay, water saturation and termite infestation
- Mortise-and-tenon joints for maximum strength and durability
- Integral nailing fin for increased strength and easy installation
- Natural wood interiors are ready for staining or painting
- Sash thickness is 2-3/32" to increase visual warmth and appeal
- Factory-applied jamb extensions available in a variety of widths
- High-performance LoE<sup>3</sup>-366 insulating glass for greater energy efficiency
- Preserve® protective film
- Full weatherstrip system for added energy efficiency and comfort
- E-Gard® operator and single-action unison lock for easy, smooth operation
- Nesting folding handle
- All push out casement windows have an E-Gard operator and two bar hinges and Truth EntryGard® dual-arm operators
- Hardware available in Chestnut Bronze, White or Desert Sand
- Full 90-degree operation makes cleaning from the interior easy and allows for full ventilation
- BetterVue™ insect screens let in more light and keep more insects out\*

### Optional features

- Glass options include argon-filled Low-E, decorative, tinted, Neat™, ImpactGard™ protection, single pane, single pane with energy panel, high-altitude insulating and tempered
- Hardware available in Oil-Rubbed Bronze\*\*, Polished Brass, Antique Brass, Brushed Chrome or Polished Chrome
- Coastal hardware for maximum corrosion resistance
- Divided lite options include simulated divided lites, full-surround wood grilles and grilles between the glass (see pages 12–13)
- Wood screen frames available in mahogany, alder, vertical-grain Douglas fir or pine
- Insect screens with Phantom Screens® Technology seamlessly integrate with the rest of the window

### Clad-wood exteriors: additional features

- 41 exterior clad colors with commercial-grade 70% Kynar 500® resin system (see page 6)
- Optional copper cladding in Bright Copper, Speckled Patina Copper or Hand-Rubbed Patina Copper
- Optional exterior trim: brickmould, 3-1/2" flat casing, Adams casing or Manchester casing
- Optional interior wood species: mahogany, alder or vertical-grain Douglas fir

### Wood exteriors: additional features

- Exterior is factory-primed and ready for painting
- Optional natural (no prime) pine, vertical-grain Douglas fir or mahogany exterior
- Optional factory-applied exterior trim: brickmould, backband, 3-1/2", 4-1/2", and 5-1/2" flat casing or Adams casing
- Optional precise simulated divided lites (see page 12)

*For complete specifications, see pages 61–94.*

*\*Insect screens are intended to allow air and light in, while keeping insects out. They are not intended to stop children from falling through an open door or window. For safety screens and other security devices, contact your local building supply retailer.*

*\*\*Oil-Rubbed Bronze will change in appearance over time.*

## DOUBLE-HUNG WINDOWS

No other windows convey the sense of traditional American design like our double-hung windows. They feature an upper and lower sash that slide vertically past each other in a single frame. The sash also tilt in for convenient cleaning. In addition, we offer double-hung sash replacement windows, which allow for easy installation.

We also offer large-scale Epic® series double-hung windows. They're ideal for either new projects or historic renovations, feature extruded sash components, and can be incorporated into new or existing rough openings that are up to 5'6" wide and 8'6" tall or up to 4'6" wide and 10'6" tall, respectively.



The double-hung sash replacement system includes all the necessary parts and hardware.



### Standard features

- Solid pine AuraLast® wood protects against wood decay, water saturation and termite infestation
- Mortise-and-tenon joints for maximum strength and durability
- Integral nailing fin for increased strength and easy installation
- Natural wood interiors are ready for staining or painting
- Sash is 1-7/16" thick
- Concealed jamb liner is recessed into side jambs and adds visual appeal
- Factory-applied jamb extensions available in a variety of widths
- Noncompression jamb liners are equipped with spring-assisted block and tackle mechanisms for smooth operation
- Both top and bottom sash tilt in for easy cleaning and removal
- High-performance LoE<sup>3</sup>-366 insulating glass for greater energy efficiency
- Preserve® protective film
- Full weatherstrip system for added energy efficiency and comfort
- Hardware available in Chestnut Bronze, White or Desert Sand
- BetterVue™ insect screens let in more light and keep more insects out\*

### Optional features

- Glass options include argon-filled Low-E, decorative, tinted, Neat™, ImpactGard™ protection, single pane, single pane with energy panel, high-altitude insulating and tempered

- Hardware available in Oil-Rubbed Bronze\*\*, Polished Brass, Antique Brass, Brushed Chrome or Polished Chrome
- Divided lite options include simulated divided lites, full-surround wood grilles and grilles between the glass (see pages 12–13)
- White or Beige jamb liner
- Insect screens with Phantom Screens® Technology seamlessly integrate with the rest of the window\*

### Clad-wood exteriors: additional features

- 41 exterior clad colors with commercial-grade 70% Kynar 500® resin system (see page 6)
- Optional copper cladding in Bright Copper, Speckled Patina Copper or Hand-Rubbed Patina Copper
- Extruded aluminum sill nosing and sill extenders are available to match cladding
- Optional exterior trim: brickmould, 3-1/2" flat casing, Adams casing or Manchester casing
- Optional interior wood species: mahogany, alder or vertical-grain Douglas fir

### Wood exteriors: additional features

- Exterior is factory-primed and ready for painting
- Optional natural (no prime) pine, vertical-grain Douglas fir or mahogany exterior
- Optional clear wood sill and sill nosing with clear exteriors
- Optional factory-applied exterior trim: brickmould, backband, 3-1/2", 4-1/2", and 5-1/2" flat casing or Adams casing
- Historic sill nosing
- Optional precise simulated divided lites (see page 12)

For complete specifications, see pages 95–139.

\*Insect screens are intended to allow air and light in, while keeping insects out. They are not intended to stop children from falling through an open door or window. For safety screens and other security devices, contact your local building supply retailer.

\*\*Oil-Rubbed Bronze will change in appearance over time.

# HORIZONTAL GLIDING WINDOWS

Streamlined horizontal gliding windows allow for ventilation without taking up additional space when open. Each one has a stationary sash and a sash that glides to the right or left in grooves or tracks. These windows also feature silicone glide buttons for smooth movement.



Exterior clad-wood

Interior pine

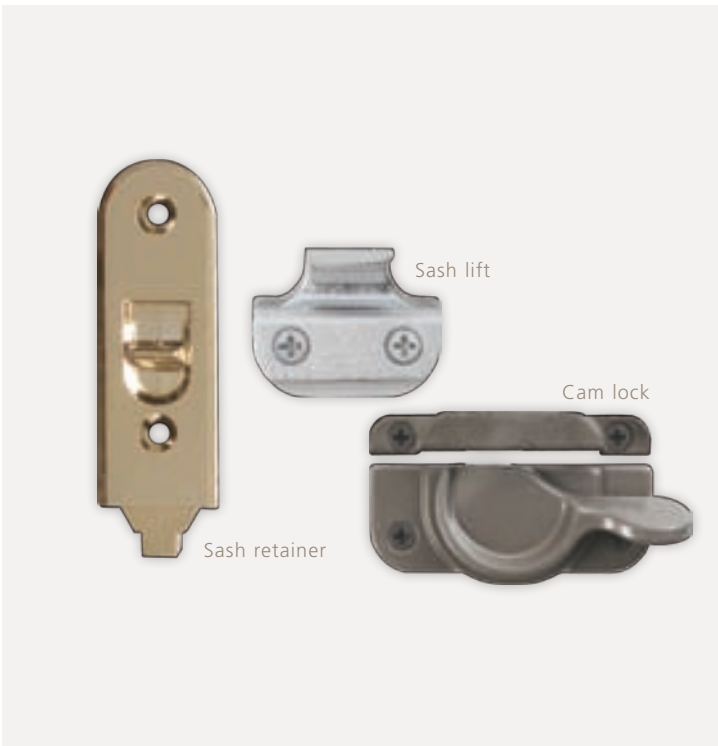

### Standard features

- Solid pine AuraLast® wood protects against wood decay, water saturation and termite infestation
- Mortise-and-tenon joints for maximum strength and durability
- Factory-applied collapsible vinyl nailing fin for easy installation
- Natural wood interiors are ready for staining or painting
- Sash is 1-7/16" thick
- Standard jamb width is 4-9/16"
- High-performance LoE<sup>3</sup>-366 insulating glass for greater energy efficiency
- Preserve® protective film
- Full weatherstrip system for added energy efficiency and comfort
- Silicone glide buttons ensure extremely smooth operation
- Hardware available in Chestnut Bronze, White or Desert Sand
- BetterVue™ insect screens let in more light and keep more insects out\*

### Optional features

- Glass options include argon-filled Low-E, decorative, tinted, Neat™, ImpactGard™ protection, single pane, single pane with energy panel, high-altitude insulating and tempered
- Hardware available in Oil-Rubbed Bronze\*\*, Polished Brass, Antique Brass, Brushed Chrome or Polished Chrome
- Divided lite options include simulated divided lites, full-surround wood grilles and grilles between the glass (see pages 12–13)
- Insect screens with Phantom Screens® Technology seamlessly integrate with the rest of the window\*

### Clad-wood exteriors: additional features

- 41 exterior clad colors with commercial-grade 70% Kynar 500® resin system (see page 6)
- Optional copper cladding in Bright Copper, Speckled Patina Copper or Hand-Rubbed Patina Copper
- Optional exterior trim: brickmould, 3-1/2" flat casing, Adams casing or Manchester casing
- Optional interior wood species: mahogany, alder or vertical-grain Douglas fir

### Wood exteriors: additional features

- Exterior is factory-primed and ready for painting
- Optional natural (no prime) pine, vertical-grain Douglas fir or mahogany exterior
- Optional factory-applied exterior trim: brickmould, backband, 3-1/2", 4-1/2", and 5-1/2" flat casing or Adams casing
- Optional precise simulated divided lites (see page 12)

*For complete specifications, see pages 146–150.*

*\*Insect screens are intended to allow air and light in, while keeping insects out. They are not intended to stop children from falling through an open door or window. For safety screens and other security devices, contact your local building supply retailer.*

*\*\*Oil-Rubbed Bronze will change in appearance over time.*

## RADIUS AND GEOMETRIC WINDOWS

Our radius and geometric windows are a distinctive choice that can emphasize a home's architecture or a stunning vista. They're available as fixed (direct or in-sash) units or operating units in a wide range of standard shapes and sizes. In addition to our standard offerings, you may select a custom design for a unique look.



Exterior clad-wood  
with Arctic Silver finish

### Standard features

- Solid pine AuraLast® wood protects against wood decay, water saturation and termite infestation
- Integral, collapsible nailing fin for increased strength and easy installation
- Natural wood interiors are ready for staining or painting
- Direct-set or in-sash units
- Sash thickness is 2-3/32" on in-sash units
- High-performance LoE<sup>3</sup>-366 insulating glass for greater energy efficiency
- Preserve® protective film
- Full weatherstrip system for added energy efficiency and comfort
- BetterVue™ insect screens let in more light and keep more insects out\*

### Optional features

- Glass options include argon-filled Low-E, decorative, tinted, Neat™, ImpactGard™ protection, single pane, single pane with energy panel, high-altitude insulating and tempered
- Hardware available in Polished Brass, Antique Brass, Polished Chrome, Brushed Chrome or Oil-Rubbed Bronze\*\*
- Coastal hardware for maximum corrosion resistance
- Divided lite options include simulated divided lites, full-surround wood grilles and grilles between the glass (see pages 12–13)

### Clad-wood exteriors: additional features

- 41 exterior clad colors with commercial-grade 70% Kynar 500® resin system (see page 6)
- Optional copper cladding in Bright Copper, Speckled Patina Copper or Hand-Rubbed Patina Copper
- Optional exterior trim: brickmould, 3-1/2" flat casing, Adams casing or Manchester casing
- Optional interior wood species: mahogany, alder or vertical-grain Douglas fir

### Wood exteriors: additional features

- Exterior is factory-primed and ready for painting
- Optional natural (no prime) pine, vertical-grain Douglas fir or mahogany exterior
- Full 1-1/4" frame construction
- Optional factory-applied exterior trim: brickmould, backband, 3-1/2", 4-1/2", and 5-1/2" flat casing or Adams casing
- Optional precise simulated divided lites (see page 12)

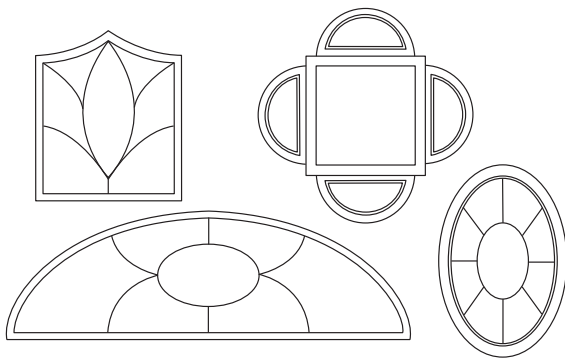

Our radius and geometric windows come in a variety of designs, including those you create yourself.

*For complete specifications, see pages 151–183.*

*\*Insect screens are intended to allow air and light in, while keeping insects out. They are not intended to stop children from falling through an open door or window. For safety screens and other security devices, contact your local building supply retailer.*

*\*\*Oil-Rubbed Bronze will change in appearance over time.*

# WOOD AND CLAD-WOOD PATIO DOORS





#### ANATOMY OF A CUSTOM WOOD PATIO DOOR

1. Head jamb
2. Rail
3. Lites
4. Grille
5. Handle set
6. Keyway
7. Glazing/ Glass
8. Side jamb
9. Sill
10. Panel



*The patio door frame consists of the head jamb, side jambs and the sill.*

Open your home to the joy of nature, or protect it from the harshest weather.  
Our enduring patio doors make it possible.

## SWINGING PATIO DOORS

Add charm to any home with French or center-swinging patio doors. These patio doors swing either out or in on side hinges. Both are built with the same design profile as our window line, which ensures architectural correctness.

In addition, we offer Epic® Series patio doors for new projects or historic renovations. They feature 6-5/8" stiles and a 10-1/4" bottom rail to incorporate commercial hardware needs.



Exterior clad-wood radius-top French swinging patio doors



Interior pine



Interior pine  
raised panel  
(horizontal)



Exterior clad-wood  
raised panel  
(dual-vertical)



Handle set



## Standard features

- Solid pine AuraLast® wood protects against wood decay, water saturation and termite infestation
- Factory-applied, collapsible vinyl nailing fin for easy installation
- Natural wood interiors are ready for staining or painting
- Door panels are 1-3/4" thick with hardwood dowel construction
- TimberStrand® core for added strength
- In-swinging and out-swinging doors feature standard Bronze extruded aluminum sills with thermal break; door panels are fitted with a dual-durometer vinyl sweep for increased energy efficiency
- High-performance LoE<sup>3</sup>-366 insulating glass for greater energy efficiency
- Preserve® protective film
- Full weatherstrip system for added energy efficiency and comfort
- Hardware in Polished Brass
- Multipoint locks for doors over 7'0" in height
- 4" x 4" hinges with stainless steel pin
- Center-swinging and four-panel French doors include a standard sliding heavy-duty extruded aluminum insect screen door\*
- Seven heights to match any construction need: retro 6'8", 8'0" and 9'0" sizes for remodeling projects; true 6'8", 7'0", 8'0" and 9'0" sizes for new construction

## Optional features

- Glass options include argon-filled Low-E, decorative, tinted, Neat™, ImpactGard™ protection, single pane, single pane with energy panel, high-altitude insulating and tempered
- Divided lite options include simulated divided lites, full-surround wood grilles and grilles between the glass (see pages 12–13)

- Hardware available in Oil-Rubbed Bronze\*\*, Antique Brass, Brushed Chrome, Polished Chrome, Powder-Coat White or Powder-Coat Black
- Stainless steel, multipoint locking system with adjustable hinges for maximum corrosion resistance and added security
- 10-1/4" bottom rail and 4-5/8" intermediate rails
- ADA-compliant sills
- Straight, radius, sector top or half-round transoms
- Sidelights in three widths: 1'0", 1'2" and 1'4"
- Factory-applied exterior jamb extenders and sill nosing extensions to accommodate walls up to 6-9/16"

## Clad-wood exteriors: additional features

- 41 exterior clad colors with commercial-grade 70% Kynar 500® resin system (see page 6)
- Optional copper cladding in Bright Copper, Speckled Patina Copper or Hand-Rubbed Patina Copper
- Optional exterior trim: brickmould, 3-1/2" flat casing, Adams casing or Manchester casing
- Optional interior wood species: mahogany, alder or vertical-grain Douglas fir

## Wood exteriors: additional features

- Exterior is factory-primed and ready for painting
- Optional natural (no prime) pine, vertical-grain Douglas fir or mahogany exterior
- Optional factory-applied exterior trim: brickmould, backband, 3-1/2", 4-1/2", and 5-1/2" flat casing or Adams casing
- Optional multipoint locking system with adjustable hinges
- Optional precise simulated divided lites (see page 12)

*For complete specifications, see pages 184–272.*

*\*Insect screens are intended to allow air and light in, while keeping insects out. They are not intended to stop children from falling through an open door or window. For safety screens and other security devices, contact your local building supply retailer.*

*\*\*Oil-Rubbed Bronze will change in appearance over time.*

# GLIDING PATIO DOORS

Our gliding patio doors join contemporary styling with the traditional warmth of wood. They open by gliding along horizontal tracks at the head and sill. Typically, they feature two panels, but they're also available in three- and four-panel designs.

Exterior clad-wood



Interior pine



Multipoint handle set



Single-point handle set



## Standard features

- Solid pine AuraLast® wood protects against wood decay, water saturation and termite infestation
- Factory-applied, collapsible vinyl nailing fin for easy installation
- Natural wood interiors are ready for staining or painting
- Door panels are 1-3/4" -thick with hardwood dowel construction
- Meeting stiles on panels align perfectly with no "out of balance" overlap
- TimberStrand® core for added strength
- Pultruded fiberglass sill, with wood interior trim and stainless steel roller track, maximizes structural integrity and durability
- Operating panels that glide on steel ball bearing tandem rollers are installed in heavy-duty housing, and adjust easily for height
- High-performance LoE<sup>3</sup>-366 insulating glass for greater energy efficiency
- Preserve® protective film
- Full weatherstrip system for added energy efficiency and comfort
- Hardware in Polished Brass
- Heavy-duty extruded aluminum insect screens in our 41 clad colors\*
- Five heights to match any construction need: retro 6'8" and 8'0" sizes for remodeling projects; true 6'8", 7'0" and 8'0" sizes for new construction

## Optional features

- Glass options include argon-filled Low-E, decorative, tinted, Neat™, ImpactGard™ protection, single pane, single pane with energy panel, high-altitude insulating and tempered

- Divided lite options include simulated divided lites, full-surround wood grilles and grilles between the glass (see pages 12–13)
- Hardware available in Oil-Rubbed Bronze\*\*, Antique Brass, Brushed Chrome, Polished Chrome, Powder-Coat White or Powder-Coat Black
- Multipoint locking system for greater security
- Straight, radius, sector top or half-round transoms
- Sidelights in three widths: 1'0", 1'2" and 1'4"
- Factory-applied exterior jamb extenders and sill nosing extensions accommodate walls up to 6-9/16"
- Bronze sill

## Clad-wood exteriors: additional features

- 41 exterior clad colors with commercial-grade 70% Kynar 500® resin system (see page 6)
- Optional copper cladding in Bright Copper, Speckled Patina Copper or Hand-Rubbed Patina Copper
- Optional exterior trim: brickmould, 3-1/2" flat casing, Adams casing or Manchester casing
- Optional interior wood species: mahogany, alder or vertical-grain Douglas fir

## Wood exteriors: additional features

- Exterior is factory-primed and ready for painting
- Optional natural (no prime) pine, vertical-grain Douglas fir or mahogany exterior
- Optional factory-applied exterior trim: brickmould, backband, 3-1/2", 4-1/2", and 5-1/2" flat casing or Adams casing
- Optional precise simulated divided lites (see page 12)

*For complete specifications, see pages 273–284.*

*\*Insect screens are intended to allow air and light in, while keeping insects out. They are not intended to stop children from falling through an open door or window. For safety screens and other security devices, contact your local building supply retailer.*

*\*\*Oil-Rubbed Bronze will change in appearance over time.*

## SIDELIGHTS AND TRANSOMS

Sidelights and transoms can increase the sense of elegance or drama in any home. A sidelight is simply a window installed on one or both sides of a patio door. A transom is a window set above another window or a door. It is fixed (direct or in-sash).



### Standard features

- Solid pine AuraLast® wood protects against wood decay, water saturation and termite infestation
- Natural wood interiors are ready for staining or painting
- High-performance LoE<sup>3</sup>-366 insulating glass for greater energy efficiency
- Preserve® protective film

### Optional features

- Glass options include argon-filled Low-E, decorative, tinted, Neat™, ImpactGard™ protection, single pane, single pane with energy panel, high-altitude insulating and tempered
- Divided lite options include simulated divided lites, full-surround wood grilles and grilles between the glass (see pages 12–13)

### Clad-wood exteriors: additional features

- 41 exterior clad colors with commercial-grade 70% Kynar 500® resin system (see page 6)
- Optional copper cladding in Bright Copper, Speckled Patina Copper or Hand-Rubbed Patina Copper
- Optional exterior trim: brickmould, 3-1/2" flat casing, Adams casing or Manchester casing
- Optional interior wood species: mahogany, alder or vertical-grain Douglas fir

### Wood exteriors: additional features

- Exterior is factory-primed and ready for painting
- Optional natural (no prime) pine, vertical-grain Douglas fir or mahogany exterior
- Optional factory-applied exterior trim: brickmould, backband, 3-1/2", 4-1/2", and 5-1/2" flat casing or Adams casing
- Optional precise simulated divided lites (see page 12)



Interior pine



# JELD-WEN® CUSTOM WOOD WINDOW AND PATIO DOOR PRODUCT SPECIFICATIONS



JELD-WEN reserves the right to change product specifications without notice. Please check our website, [www.jeld-wen.com](http://www.jeld-wen.com), for current information.



# CUSTOM WOOD—WARRANTY

## JELD-WEN® WOOD and METAL-CLAD-WOOD Window & Patio Door Warranty

### Our Warranty to You

JELD-WEN® products<sup>1</sup> are designed to create lasting value for your home. This warranty is effective for all JELD-WEN wood and metal clad wood products manufactured on or after **January 1, 2008** for use in the United States and Canada. Any previous warranties will continue to apply to products manufactured by JELD-WEN prior to this date. For additional information, including care, maintenance and installation instructions, refer to [www.jeld-wen.com](http://www.jeld-wen.com).

### What This Warranty Covers

We warrant that JELD-WEN products will be free from defects in material or workmanship as identified below from the date of manufacture for the time periods described below. This warranty includes **free** replacement parts to replace components of the window or patio door. Skilled labor<sup>2</sup> (where deemed necessary by us) to repair or replace components is provided for **two (2)** years (unless specified otherwise).

**Twenty Year Limited Warranty for Window & Patio Door Products (insulating glass, metal clad and wood parts, and hardware unless specified otherwise):** We warrant your window, patio door and component parts (e.g. exterior casing provided by JELD-WEN) thereof for **twenty (20)** years. This includes coverage for twenty (20) years for wood cellular structure failure (often referred to as "wood cellular breakdown") caused by decay and/or termites in JELD-WEN manufactured **pine** wood products. Warranty coverage outside Canada, the contiguous 48 states and Alaska is contingent upon approval from the JELD-WEN Customer Care Department. Please contact us.

**Clad Finish\*:** Under normal atmospheric conditions, the clad finish on your metal-clad window or patio door manufactured by us will be free from defects as follows:

- Custom Collection Kynar® finishes are warranted for **twenty (20)** years and will not peel, check, crack, or exhibit excessive chalk, fade or color change.<sup>3</sup>
- All other products that include polyester finishes are warranted for **ten (10)** years and will not peel, check, crack, or exhibit excessive chalk, fade or color change.<sup>3</sup>

\*The term "clad finish" means the painted finish on metal cladding. Clad products installed within one mile of a saltwater source (or other corrosive environment) require additional and specific maintenance requirements. Refer to our full care and maintenance instructions.

### Special Coverages

**ImpactGard® Glass:** We warrant each ImpactGard glass unit for **ten (10)** years.

**Special Glazings** (including laminate glass units other than ImpactGard): We warrant special glazings (including glass options not listed in our product literature, e.g., leaded or decorative glass) for **five (5)** years.

**Electric Operators:** We warrant electric operators provided by us for **one (1)** year (to include free replacement parts and skilled labor necessary to replace the operator for **one (1)** year).

**Spontaneous Glass Breakage:** We warrant sealed glass units installed in windows and patio doors (excluding laminated glass, and special glazings) for spontaneous breakage for **one (1)** year (to include free replacement glass and skilled labor necessary to replace the glass for **one (1)** year). Spontaneous breakage occurs when the glass develops a crack without sign of impact.

**Transferability:** In the event you sell your residence/building, this warranty is transferable to subsequent owners. In the event you sell your residence/building or it becomes occupied by other than the original owner, the warranty is **ten (10)** years from the date of manufacture (except as indicated under Special Coverages above).

### How to Get Assistance

If you have a problem with your JELD-WEN product, contact the dealer/distributor or contractor from whom you purchased your product or contact us directly:

**Mail:** JELD-WEN Customer Care

**Attn:** Wood/Metal Clad Wood Warranty Claims  
P.O. Box 1329, Klamath Falls, OR 97601

**Email:** [jwoodwarranty@jeld-wen.com](mailto:jwoodwarranty@jeld-wen.com)

**Fax:** 800-436-5954

**Phone:** 888-JWHelpU (888-594-3578)

We can respond quickly and efficiently if you provide the following: a) product identification (from the original order/invoice, spacer code, permanent label, or the window identification number found on corner of glass), b) how to contact you, c) the address where the product can be inspected, and d) a description of the apparent problem and the product (photographs are helpful).

### What We Will Do

Upon receiving your notification, we will send out an acknowledgement within three business days. We will investigate your claim and will begin to take appropriate action within 30 days after notification. If it is determined that the product does not have a defect covered by the labor warranty, we may charge an inspection fee for any onsite inspection that is required or requested by you. Because manufacturing materials and techniques can change, replacement part(s) may not be an aesthetic match to the original. Replacement components/products are warranted for the balance of the original product warranty or 90 days, whichever is longer. If we determine we are unable to provide replacement parts and repair is not practicable or cannot be made timely, then we will refund the unit/component purchase price. This guarantee gives you specific legal rights, and you may have other rights that vary from state/province to state/province.

### What This Warranty Does Not Cover

**JELD-WEN is not liable for:**

- Normal wear and tear; natural weathering of surfaces. Variance in color or texture of natural wood parts, and natural tarnishing of copper cladding are not considered defects.
- Normal wear and tear to hardware and naturally occurring changes to hardware finishes (e.g., corrosion or tarnishing).
- Damage caused by chemicals (e.g. brick wash) or a harsh environment (e.g. salt spray or airborne pollutants) unless otherwise stated above.
- Product failure due to misuse or abuse; damage caused by failure to properly finish and provide maintenance, by alteration or modification to the window (e.g. customer applied tints or films, paint finishes, security systems), or as a result of any cause beyond the control of JELD-WEN (e.g. fire, flood, earthquake, other acts of nature, and acts of third parties outside of our control).
- Glass breakage (except spontaneous breakage as covered above).
- Slight imperfections or wavy distortions in the glass that don't impair structural integrity. Note: wavy distortions in the glass (e.g. related to laminate interlayer or heat strengthening of glass) are not considered a defect. Slight color variations in glass are not considered a defect.
- Improper installation not in conformance with JELD-WEN installation instructions (Note: see [www.jeld-wen.com](http://www.jeld-wen.com) for current installation instructions); operational problems and problems related to water and/or air infiltration/leaking as a result of improper installation or flaws in building design or construction.
- Damage or poor product performance resulting from installation into a condition that exceeds product design standards and/or certified performance specifications and/or is not in compliance with building codes.
- Damage caused by extreme artificial temperature buildup or exposure (e.g., where storm doors/windows are present).
- Product or component performance decline due to aging, inert gas dissipation, natural processes or failure to provide proper maintenance. Note: Other than inert gas loss due to seal failure, the migration of an inert gas, such as argon, is a natural process that occurs over time and is not a defect.
- Screen damage due to normal wear and tear, misuse, abuse, or insect or animal activity.
- Condensation or damage as a result of condensation (Note: unless due to insulating glass failure, most condensation problems are related to excessive humidity levels in a structure; contact a heating/air conditioning specialist for help).
- Labor and materials for repainting or refinishing activities, or the removal or disposal of defective product(s); labor exceeding the time periods specified above.
- Wood cellular structure failure for wood components other than of pine species and any components (including pine) that come in direct contact with soil. (Note: superficial mold/mildew does not indicate wood cellular structure failure.)
- Incidental or consequential damage. Some states/provinces do not allow the exclusion or limitation of incidental or consequential damages, so this may not apply to you.

### IMPORTANT LEGAL INFORMATION

**This Warranty sets forth our maximum liability for our products. We shall not be liable for special, indirect, consequential, or incidental damages. Your sole and exclusive remedy with respect to any and all losses or damages resulting from any cause whatsoever shall be as specified above. We make no other warranty or guarantee, either express or implied, including implied warranties of merchantability and fitness for a particular purpose to the original purchaser or to any subsequent user of the product, except as expressly contained herein. In the event state or provincial law precludes exclusion or limitation of implied warranties, the duration of any such warranties shall be no longer than, and the time and manner of presenting any claim thereon shall be the same as, that provided in the express warranty stated herein.**

<sup>1</sup> "JELD-WEN products" shall refer to wood and metal clad wood window and patio door products manufactured in the United States and marketed under the JELD-WEN brand name for use in the United States and Canada. See our separate Export Warranty for applicable coverage on products used outside the United States and Canada.

<sup>2</sup> "Skilled labor" refers to tasks where specialized technical knowledge, experience, methods or tools are required to properly identify, diagnose and/or correct product-related problems.

<sup>3</sup> "Chalking" of the clad finish is not a defect unless it exceeds a numerical rating of eight (8) when measured in accordance with the standard procedures specified in ASTM D4214. Fading or changing in color of the "clad finish" is not a defect unless it exceeds five (5) E units (NBS), calculated in accordance with ASTM D2244, paragraph 6.3. Color change shall be measured on an exposed "clad finish" that has been cleaned of surface soils and chalk, and the corresponding values measured on the original or unexposed "clad finish." Fading or color changes may not be uniform if the surfaces are not equally exposed to the sun and elements. If the above ASTM standards change, the standard in effect at the time of purchase applies. As an option to replacement, we may choose to refinish the product.

©2008, JELD-WEN, inc. | JELD-WEN and ImpactGard are registered trademarks of JELD-WEN, inc., OREGON, USA. All other trademarks are the property of their respective owners.



## About JELD-WEN

Since 1960, when JELD-WEN began as a small Oregon millwork plant, we've been dedicated to creating reliable windows and doors that are energy efficient, beautiful and worry-free.

JELD-WEN is also proud to be a member of the Green Building Initiative (GBI). GBI is a nonprofit organization that accelerates green building practices by promoting environmentally progressive approaches that are practical, affordable and accessible to mainstream builders, architects and developers. As a member, we help state and local homebuilder associations develop local green building programs that are appropriate for their regions. These programs then help builders develop homes that are energy efficient, healthier to live in, and better for the environment.

JELD-WEN believes in supporting our communities. One way we do this is through the JELD-WEN Tradition Foundation, which provides charitable funds to educational organizations. We've been the title sponsor of the JELD-WEN Tradition on the PGA TOUR's Champions Tour since 2003; we're a Proud Partner of THE PLAYERS; and we're the official window, door and millwork provider on the PGA TOUR.



The JELD-WEN website is your ultimate resource for learning about our reliable windows and doors. It has all the product information and design advice you need. Visit us at [www.jeld-wen.com](http://www.jeld-wen.com) today.

**RELIABILITY** *for real life*<sup>®</sup>



Official window, door and millwork provider of the PGA TOUR and Champions Tour

**JELD-WEN**<sup>®</sup>  
WINDOWS & DOORS



©2008, 2004 JELD-WEN, inc. JELD-WEN, AuraLast, Epic, ImpactGard and Reliability for real life are trademarks or registered trademarks of JELD-WEN, inc., Oregon, USA. Phantom Screens<sup>®</sup> is a registered trademark of Phantom Mfg. (Int'l) Ltd. All other trademarks are the property of their respective owners.

JELD-WEN reserves the right to change product specifications without notice. Please check our website, [www.jeld-wen.com](http://www.jeld-wen.com), for the most current information.

**11-065 4/08** (CDS 15M 867)