

*Frigidaire*

Refrigeration



# Frigidaire

## Cool innovation.

Since the invention of the refrigerator, Frigidaire® has been an innovator in home refrigeration.

So you expect exterior styling that is space-efficient and adapts to any kitchen environment.

You trust our precision temperature and electronic controls that tell you when power has been interrupted and for how long.

You count on SpillSafe™ shelves that catch and hold spills for easy cleanup and a SmartFit™ shelf that easily adjusts up or down without removing contents.

And, you appreciate the purity of the PureSource 2® ice & water filtration system which provides fresher, cleaner tasting ice and water. You can rely on the PureAir™ fan-forced air filter for maintaining a baking soda fresh interior.

You expect all this from Frigidaire®...and we deliver.



## Counter-Depth Refrigerator Features



**EasyCare™ Genuine Stainless Steel with Color-Coordinated Stainless-Look Trim**  
EasyCare™ Genuine Stainless Steel is surface coated to minimize fingerprints and smudges. Color-coordinated stainless-look trim completes the overall look.



**Sliding SmartFit™ SpillSafe™ Glass Shelf**  
A turn of the handle allows you to easily raise or lower shelf height without removing contents. The encased SpillSafe™ glass shelf catches and holds spills for easy cleanup and slides in and out for easy access.



**Precision Temperature & Electronic Controls**  
Digital display shows exact temperature and settings while warning indicators signal when power has been interrupted, door is ajar or high temperature has occurred.



**PureSource 2® Ice & Water Filtration System**  
Twin carbon block filter cassette effectively protects against lead, chlorine, cysts and particulates. The no-spill cassette can be replaced with the push of a button every 400 gallons (6 to 9 months).



**PureAir™ Fan-Forced Air Filtration**  
Eliminates odors and keeps your refrigerator interior cleaner and fresher. An indicator light signals when the charcoal and baking soda filter can be easily replaced.



**Transition Lighting**  
Refrigerator interior illuminates gradually, allowing eyes the time to adjust regardless of ambient conditions.



**Clear Adjustable Door Bins with No-Slip Liners**  
Adjustable door bins offer maximum storage capacity with the convenience to lift and snap into place. The no-slip liners line the bottom of the bin and help prevent stored items from sliding.



**Fresh Lok™ Hydrators**  
For enhanced food preservation, Fresh Lok™ lets you specify humidity levels and temperatures within a range of 33°F to 39°F.



**Tilt-Out Wire Door Shelves**  
Tilt-out feature makes access easy while wire construction provides secure storage and complete visibility.

# Frigidaire



## Professional Series®

**PHSC39EH SS**

22.6 Cubic Feet



### Refrigerator Section:

- SpaceWise™ Design
- UltraSoft™ EasyCare™ Genuine Stainless Steel Doors
- UltraPro Stainless Steel Handles
- Color-Coordinated Stainless Look Finish Cabinet, Full-Width Hinge Cover, Clean Touch Dispenser and Toe Grille
- PureAir™ Fan-Forced Air Filter with Filter Change Light
- Front-Mounted PureSource 2® Ice & Water Filter with Filter Change Light
- Front-Mounted Cold Controls
- Backlit Control Panel with Electronic Digital Temperature Setting Display
- Door Ajar/ Temperature/ Power Failure Alarm
- 7 Button Clean Touch Dispenser with Lock
- Crushed/ Cubes/ Water/ Extra Ice/ Extreme Freeze
- Illuminated Dispenser Paddles
- 1 SmartFit™ Glass Shelf
- 2 SpillSafe™ Glass Shelves (1 Sliding)
- 1 Fixed Clear Gallon Door Bin with No-Slip Liner
- 2 Adjustable Clear 2-Liter Door Bins with No-Slip Liners
- 1 Fixed Clear Condiment Bin
- Removable Dairy Compartment with Clear Door
- Clear Fresh Lok™ Meatkeeper
- 2 Clear Crispers (1 Divided)
- 3 Humidity Controls
- Transition Lighting
- Clear In-Door Can Rack
- Clear Wine Rack

### Freezer Section:

- 2 Clear Upper Bins
- 2 Tilt-Out Wire Shelves
- 2 Glass Shelves
- 1 Tall Full Extension Basket
- 1 Tall Basket
- 1 Regular Basket
- Space-Saver Shelf

### Available In:

- Stainless Steel/ Stainless Look Finish



**Panel-Kit Ready**  
Counter-depth model GHSC39ETH is designed to be panel-kit ready to accept either white, black or stainless steel door panels or custom-built cabinet panels, to match your kitchen's décor. (For optional Door Panel Kits, see page 39.)

Model GHSC39ETH S is shown with optional stainless steel door panels.



## Gallery Series®

### GHSC39ETH S

22.6 Cubic Feet



#### Refrigerator Section:

- SpaceWise™ Design
- Panel-Kit Ready
- Color-Coordinated Clean Touch Dispenser and Toe Grille
- Full-Length Stainless Steel Handles
- PureAir™ Fan-Forced Air Filter with Filter Change Light
- Front-Mounted PureSource 2® Ice & Water Filter with Filter Change Light
- Front-Mounted Cold Controls
- Backlit Control Panel with Electronic Digital Temperature Setting Display
- Door Ajar/Temperature/Power Failure Alarm
- 7 Button Clean Touch Dispenser with Lock
- Crushed/Cubes/Water/Extra Ice/Extreme Freeze
- Illuminated Dispenser Paddles
- 1 SmartFit™ Glass Shelf
- 2 SpillSafe™ Glass Shelves (1 Sliding)
- 1 Fixed Clear Gallon Door Bin with No-Slip Liner
- 2 Adjustable Clear 2-Liter Door Bins with No-Slip Liners
- 1 Fixed Clear Condiment Bin
- Removable Dairy Compartment with Clear Door
- Clear Fresh Lok™ Meatkeeper
- 2 Clear Crispers (1 Divided)
- 3 Humidity Controls
- Transition Lighting
- Clear In-Door Can Rack
- Clear Wine Rack

#### Freezer Section:

- 2 Clear Upper Bins
- 2 Tilt-Out Wire Shelves
- 2 Glass Shelves
- 1 Tall Full Extension Basket
- 1 Tall Basket
- 1 Regular Basket
- Space-Saver Shelf

#### Available In:

- Stainless Steel/Black

# Frigidaire

## Gallery Series® GHSC39ETH W/B 22.6 Cubic Feet



### Refrigerator Section:

- SpaceWise™ Design
- Panel-Kit Ready
- Full-Length Color-Coordinated Handles
- PureAir™ Fan-Forced Air Filter with Filter Change Light
- Front-Mounted PureSource 2® Ice & Water Filter with Filter Change Light
- Front-Mounted Cold Controls
- Backlit Control Panel with Electronic Digital Temperature Setting Display
- Door Ajar/Temperature/Power Failure Alarm
- 7 Button Clean Touch Dispenser with Lock
- Crushed/Cubes/Water/Extra Ice/Extreme Freeze
- Illuminated Dispenser Paddles
- 1 SmartFit™ Glass Shelf
- 2 SpillSafe™ Glass Shelves (1 Sliding)
- 1 Fixed Clear Gallon Door Bin with No-Slip Liner
- 2 Adjustable Clear 2-Liter Door Bins with No-Slip Liners
- 1 Fixed Clear Condiment Bin
- Removable Dairy Compartment with Clear Door
- Clear Fresh Lok™ Meatkeeper
- 2 Clear Crispers (1 Divided)
- 3 Humidity Controls
- Transition Lighting
- Clear In-Door Can Rack
- Clear Wine Rack

### Freezer Section:

- 2 Clear Upper Bins
- 2 Tilt-Out Wire Shelves
- 2 Glass Shelves
- 1 Tall Full Extension Basket
- 1 Tall Basket
- 1 Regular Basket
- Space-Saver Shelf

### Available In:

- White and Black

**Panel-Kit Ready**  
Counter-depth model GHSC39ETH is designed to be panel-kit ready to accept either white, black or stainless steel door panels or custom-built cabinet panels, to match your kitchen's décor. (For optional Door Panel Kits, see page 39.)

Model GHSC39ETH B is shown with custom-built cabinet panels.



## Gallery Series®

### GHSC39EH PW/PB

22.6 Cubic Feet



#### Refrigerator Section:

- SpaceWise™ Design
- UltraSoft™ Doors with Full-Width Hinge Cover
- UltraPro Color-Coordinated Steel Handles
- PureAir™ Fan-Forced Air Filter with Filter Change Light
- Front-Mounted PureSource 2® Ice & Water Filter with Filter Change Light
- Front-Mounted Cold Controls
- Backlit Control Panel with Electronic Digital Temperature Setting Display
- Door Ajar/Temperature/Power Failure Alarm
- 7 Button Clean Touch Dispenser with Lock
- Crushed/Cubes/Water/Extra Ice/Extreme Freeze
- Illuminated Dispenser Paddles
- 1 SmartFit™ Glass Shelf
- 2 SpillSafe™ Glass Shelves (1 Sliding)
- 1 Fixed Clear Gallon Door Bin with No-Slip Liner
- 2 Adjustable Clear 2-Liter Door Bins with No-Slip Liners
- 1 Fixed Clear Condiment Bin
- Removable Dairy Compartment with Clear Door
- Clear Fresh Lok™ Meatkeeper
- 2 Clear Crispers (1 Divided)
- 3 Humidity Controls
- Transition Lighting
- Clear In-Door Can Rack
- Clear Wine Rack

#### Freezer Section:

- 2 Clear Upper Bins
- 2 Tilt-Out Wire Shelves
- 2 Glass Shelves
- 1 Tall Full Extension Basket
- 1 Tall Basket
- 1 Regular Basket
- Space-Saver Shelf

#### Available In:

- Pearl White and Pearl Black

# Frigidaire



## Frigidaire® FSC23F7H SB

22.6 Cubic Feet

### Refrigerator Section:

- SpaceWise™ Design
- UltraSoft™ EasyCare™ Genuine Stainless Steel Doors with Full-Width Hinge Cover
- UltraPro Stainless Steel Handles
- Front-Mounted PureSource 2® Ice & Water Filter with Filter Change Light
- Front-Mounted Cold Controls
- Backlit Control Panel with Electronic Digital Temperature Setting Display
- Door Ajar Alarm
- 6 Button Clean Touch Dispenser with Lock
- Crushed/Cubes/Water/Extra Ice
- Illuminated Dispenser Paddles
- 3 SpillSafe™ Glass Shelves (2 Sliding)
- 1 Fixed Clear Gallon Door Bin with No-Slip Liner
- 2 Adjustable Clear 2-Liter Door Bins with No-Slip Liners
- 1 Fixed Clear Condiment Bin
- Removable Dairy Compartment with Clear Door
- Clear Fresh Lok™ Meatkeeper
- 2 Clear Crispers
- 2 Humidity Controls
- Dual-Level Lighting
- Clear In-Door Can Rack
- Clear Wine Rack

### Freezer Section:

- 3 Fixed Clear Bins
- 1 Tilt-Out Wire Shelf
- 2 Glass Shelves
- 2 Tall Baskets
- Space-Saver Shelf

### Available In:

- Stainless Steel/Black

Also Available:

**FSC23F7H W/B**  
22.6 Cubic Feet

- UltraSoft™ Doors
- UltraPro Color-Coordinated Steel Handles
- Available in White and Black





## Frigidaire® FSC23R5D SB

22.6 Cubic Feet

### Refrigerator Section:

- SpaceWise™ Design
- UltraSoft™ Stainless Steel Doors
- UltraSoft™ Black Handles
- Rear-Mounted PureSource® Ice & Water Filter
- Front-Mounted Cold Controls
- Backlit Control Panel with Electronic 1-9 Numeric Setting Display
- 4 Button Dispenser
- Crushed/Cubes/Water
- 3 SpillSafe™ Glass Shelves
- 1 Fixed White Gallon Door Bin
- 2 Adjustable White 2-Liter Door Bins
- 1 Fixed White Condiment Bin
- Removable Dairy Compartment with Clear Door
- Clear Fresh Lok™ Meatkeeper
- 2 Clear Crispers
- 1 Humidity Control
- Dual-Level Lighting
- White In-Door Can Rack

### Freezer Section:

- 4 Fixed White Bins
- 3 Wire Shelves
- 1 Tall Basket
- Space-Saver Shelf

### Available In:

- Stainless Steel/Black



Also Available:

## FSC23R5D W/B

22.6 Cubic Feet

- UltraSoft™ Doors and Handles
- Available in White and Black

# Frigidaire

## Side-By-Side Refrigerator Features



**EasyCare™ Genuine Stainless Steel with Color-Coordinated Stainless-Look Trim**  
EasyCare™ Genuine Stainless Steel is surface coated to minimize fingerprints and smudges. Color-coordinated stainless-look trim completes the overall look.



**Sliding SmartFit™ SpillSafe™ Glass Shelf**  
A turn of the handle allows you to easily raise or lower shelf height without removing contents. The encased SpillSafe™ glass shelf catches and holds spills for easy cleanup and slides in and out for easy access.



**Precision Temperature & Electronic Controls**  
Digital display shows exact temperature and settings while warning indicators signal when power has been interrupted, door is ajar or high temperature has occurred.



**PureSource 2® Ice & Water Filtration System**  
Twin carbon block filter cassette effectively protects against lead, chlorine, cysts and particulates. The no-spill cassette can be replaced with the push of a button every 400 gallons (6 to 9 months).



**PureAir™ Fan-Forced Air Filtration**  
Eliminates odors and keeps your refrigerator interior cleaner and fresher. An indicator light signals when the charcoal and baking soda filter can be easily replaced.



**Transition Lighting**  
Refrigerator interior illuminates gradually, allowing eyes the time to adjust regardless of ambient conditions.



**Clear Adjustable Door Bins with No-Slip Liners**  
Adjustable door bins offer maximum storage capacity with the convenience to lift and snap into place. The no-slip liners line the bottom of the bin and help prevent stored items from sliding.



**Fresh Lok™ Hydrators**  
For enhanced food preservation, Fresh Lok™ lets you specify humidity levels and temperatures within a range of 33°F to 39°F.



**Tilt-Out Wire Door Shelves**  
Tilt-out feature makes access easy while wire construction provides secure storage and complete visibility.



## Professional Series®

**PHS69EH SS**

26.0 Cubic Feet



### Refrigerator Section:

- UltraSoft™ EasyCare™ Genuine Stainless Steel Doors
- UltraPro Stainless Steel Handles
- Color-Coordinated Stainless Look Finish Cabinet, Full-Width Hinge Cover, Clean Touch Dispenser and Toe Grille
- PureAir™ Fan-Forced Air Filter with Filter Change Light
- Front-Mounted PureSource 2® Ice & Water Filter with Filter Change Light
- Front-Mounted Cold Controls
- Backlit Control Panel with Electronic Digital Temperature Setting Display
- Door Ajar Alarm
- 7 Button Clean Touch Dispenser with Lock
- Crushed/Cubes/Water/Extra Ice/Extreme Freeze
- Illuminated Dispenser Paddles
- 1 SmartFit™ Glass Shelf
- 2 SpillSafe™ Glass Shelves (1 Sliding)
- 3 Adjustable Clear Gallon Door Bins (2 with No-Slip Liners)
- 2 Fixed Clear 2-Liter Door Bins
- Clear Dairy Door
- Clear Fresh Lok™ Meatkeeper
- 2 Clear Crispers (1 Divided)
- 3 Humidity Controls
- Transition Lighting
- White Can Dispenser/Wine Rack

### Freezer Section:

- 2 Fixed Clear Door Bins
- 3 Tilt-Out Wire Shelves
- 2 Glass Shelves
- 1 Tall Full Extension Basket
- 1 Tall Basket
- 1 Regular Basket
- Space-Saver Shelf
- Pizza Rack

### Available In:

- Stainless Steel/Stainless Look Finish

Also Available:

**PHS39EH SS**

22.6 Cubic Feet



(Does Not Include Pizza Rack)

- 2 Humidity Controls

# Frigidaire



## Professional Series®

**PHS67EH SB**

26.0 Cubic Feet



### Refrigerator Section:

- UltraSoft™ EasyCare™ Genuine Stainless Steel Doors
- UltraPro Stainless Steel Handles
- Color-Coordinated Stainless Look Finish Full-Width Hinge Cover, Clean Touch Dispenser and Toe Grille
- Front-Mounted PureSource 2® Ice & Water Filter with Filter Change Light
- Front-Mounted Cold Controls
- Backlit Control Panel with Electronic Digital Temperature Setting Display
- 5 Button Clean Touch Dispenser
- Crushed/Cubes/Water/Extra Ice
- Illuminated Dispenser Paddles
- 3 SpillSafe™ Glass Shelves (1 Sliding)
- 2 Adjustable Clear Gallon Door Bins with No-Slip Liners
- 2 Fixed Clear 2-Liter Door Bins
- Clear Dairy Door
- Clear Fresh Lok™ Meatkeeper
- 2 Clear Crispers
- 2 Humidity Controls
- Crisper Lighting

### Freezer Section:

- 5 Fixed White Door Bins
- 2 Glass Shelves
- 2 Tall Baskets
- Pizza Rack

### Available In:

- Stainless Steel/Black

Also Available:

**PHS37EH SB**

22.6 Cubic Feet



(Does Not Include  
Pizza Rack)



## Gallery Series®

### GLHS69EH SB

26.0 Cubic Feet



#### Refrigerator Section:

- UltraSoft™ EasyCare™ Genuine Stainless Steel Doors with Full-Width Hinge Cover
- UltraPro Stainless Steel Handles
- PureAir™ Fan-Forced Air Filter with Filter Change Light
- Front-Mounted PureSource 2° Ice & Water Filter with Filter Change Light
- Front-Mounted Cold Controls
- Backlit Control Panel with Electronic Digital Temperature Setting Display
- Door Ajar Alarm
- 7 Button Clean Touch Dispenser with Lock
- Crushed/Cubes/Water/Extra Ice/Extreme Freeze
- Illuminated Dispenser Paddles
- 3 SpillSafe™ Glass Shelves (1 Sliding)
- 3 Adjustable Clear Gallon Door Bins (2 with No-Slip Liners)
- 2 Fixed Clear 2-Liter Door Bins
- Clear Dairy Door
- Clear Fresh Lok™ Meatkeeper
- 2 Clear Crispers
- 2 Humidity Controls
- Tri-Level Lighting
- White Can Dispenser/Wine Rack

#### Freezer Section:

- 4 Fixed White Door Bins
- 1 Tilt-Out Wire Shelf
- 2 Glass Shelves
- 2 Tall Baskets
- Pizza Rack

#### Available In:

- Stainless Steel/Black

Also Available:

### GLHS39EH SB

22.6 Cubic Feet



(Does Not Include  
Pizza Rack)

# Frigidaire



## Gallery Series®

**GLHS69EH PW/PB/W/B**

26.0 Cubic Feet



### Refrigerator Section:

- UltraSoft™ Doors with Full-Width Hinge Cover
- UltraPro Color-Coordinated Steel Handles
- PureAir™ Fan-Forced Air Filter with Filter Change Light
- Front-Mounted PureSource 2® Ice & Water Filter with Filter Change Light
- Front-Mounted Cold Controls
- Backlit Control Panel with Electronic Digital Temperature Setting Display
- Door Ajar Alarm
- 7 Button Clean Touch Dispenser with Lock
- Crushed/Cubes/Water/Extra Ice/Extreme Freeze
- Illuminated Dispenser Paddles
- 3 SpillSafe™ Glass Shelves (1 Sliding)
- 3 Adjustable Clear Gallon Door Bins (2 with No-Slip Liners)
- 2 Fixed Clear 2-Liter Door Bins
- Clear Dairy Door
- Clear Fresh Lok™ Meatkeeper
- 2 Clear Crispers
- 2 Humidity Controls
- Tri-Level Lighting
- White Can Dispenser/Wine Rack

### Freezer Section:

- 4 Fixed White Door Bins
- 1 Tilt-Out Wire Shelf
- 2 Glass Shelves
- 2 Tall Baskets
- Space-Saver Shelf
- Pizza Rack

### Available In:

- Pearl White, Pearl Black, White and Black

Also Available:

**GLHS39EH PW/PB/W/B**

22.6 Cubic Feet



(Does Not Include  
Pizza Rack)



## Gallery Series®

### GLHS65EH SB

26.0 Cubic Feet



#### Refrigerator Section:

- UltraSoft™ EasyCare™ Genuine Stainless Steel Doors
- UltraSoft™ Black Handles
- Front-Mounted PureSource 2® Ice & Water Filter
- Front-Mounted Cold Controls
- Backlit Control Panel with Electronic Digital Temperature Setting Display
- Door Ajar Alarm
- 5 Button Clean Touch Dispenser
- Crushed/Cubes/Water/Extra Ice
- 3 SpillSafe™ Glass Shelves
- 2 Adjustable Clear Gallon Door Bins with No-Slip Liners
- 2 Fixed Clear 2-Liter Door Bins
- Clear Dairy Door
- Clear Deli Drawer
- Clear Crispers
- Crisper Lighting
- 2 Humidity Controls

#### Freezer Section:

- 4 Fixed White Door Bins
- 3 Wire Shelves
- 1 Tall Basket

#### Available In:

- Stainless Steel/Black

Also Available:

### GLHS35EH SB

22.6 Cubic Feet



# Frigidaire



## Gallery Series®

**GLHS65EH W/B**

26.0 Cubic Feet



### Refrigerator Section:

- UltraSoft™ Doors
- UltraSoft™ Handles
- Front-Mounted PureSource 2® Ice & Water Filter
- Front-Mounted Cold Controls
- Backlit Control Panel with Electronic Digital Temperature Setting Display
- Door Ajar Alarm
- 5 Button Clean Touch Dispenser
- Crushed/Cubes/Water/Extra Ice
- 3 SpillSafe™ Glass Shelves
- 2 Adjustable Clear Gallon Door Bins with No-Slip Liners
- 2 Fixed Clear 2-Liter Door Bins
- Clear Dairy Door
- Clear Deli Drawer
- Clear Crispers
- Crisper Lighting
- 2 Humidity Controls

### Freezer Section:

- 4 Fixed White Door Bins
- 3 Wire Shelves
- 1 Tall Basket

### Available In:

- White and Black

Also Available:

**GLHS35EH W/B**

22.6 Cubic Feet







**Frigidaire®**  
**FRS6HR5H SB**  
 26.0 Cubic Feet



**Refrigerator Section:**

- UltraSoft™ EasyCare™ Genuine Stainless Steel Doors
- UltraSoft™ Black Handles
- Rear-Mounted PureSource® Ice & Water Filter
- Front-Mounted Cold Controls
- Backlit Control Panel with Electronic 1-9 Numeric Setting Display
- Door Ajar Alarm
- 4 Button Dispenser
- Crushed/Cubes/Water
- 3 SpillSafe™ Glass Shelves
- 2 Adjustable Clear Gallon Door Bins

- 2 Fixed Clear 2-Liter Door Bins
- Clear Dairy Door
- Clear Deli Drawer
- Clear Crispers
- 1 Humidity Control

**Freezer Section:**

- 4 Fixed White Door Bins
- 3 Wire Shelves
- 1 Tall Basket

**Available In:**

- Stainless Steel/Black



**Frigidaire®**  
**FRS6HR5H MB**  
 26.0 Cubic Feet



**Refrigerator Section:**

- UltraSoft™ Silver Mist Finish Doors
- UltraSoft™ Black Handles
- Rear-Mounted PureSource® Ice & Water Filter
- Front-Mounted Cold Controls
- Backlit Control Panel with Electronic 1-9 Numeric Setting Display
- Door Ajar Alarm
- 4 Button Dispenser
- Crushed/Cubes/Water
- 3 SpillSafe™ Glass Shelves
- 2 Adjustable Clear Gallon Door Bins

- 2 Fixed Clear 2-Liter Door Bins
- Clear Dairy Door
- Clear Deli Drawer
- Clear Crispers
- 1 Humidity Control

**Freezer Section:**

- 4 Fixed White Door Bins
- 3 Wire Shelves
- 1 Tall Basket

**Available In:**

- Silver Mist Finish/Black

Also Available:

**FRS3HR5H MB**  
 22.6 Cubic Feet



# Frigidaire



## Frigidaire® FRS6HR5H W/Q/B 26.0 Cubic Feet



### Refrigerator Section:

- UltraSoft™ Doors
- UltraSoft™ Handles
- Rear-Mounted PureSource® Ice & Water Filter
- Front-Mounted Cold Controls
- Backlit Control Panel with Electronic 1-9 Numeric Setting Display
- Door Ajar Alarm
- 4 Button Dispenser
- Crushed/Cubes/Water
- 3 SpillSafe™ Glass Shelves
- 2 Adjustable Clear Gallon Door Bins
- 2 Fixed Clear 2-Liter Door Bins

- Clear Dairy Door
- Clear Deli Drawer
- Clear Crispers
- 1 Humidity Control

### Freezer Section:

- 4 Fixed White Door Bins
- 3 Wire Shelves
- 1 Tall Basket

### Available In:

- White, Bisque and Black

Also Available:

## FRS3HR5H W/Q/B 22.6 Cubic Feet



## Frigidaire® FRS6HR4H W/B 26.0 Cubic Feet



### Refrigerator Section:

- UltraSoft™ Doors
- Rear-Mounted PureSource® Ice & Water Filter
- Front-Mounted Cold Controls
- 4 Button Dispenser
- Crushed/Cubes/Water
- 3 SpillSafe™ Glass Shelves
- 2 Adjustable White Gallon Door Bins
- 2 Fixed White 2-Liter Door Bins
- Clear Dairy Door
- Clear Crispers

### Freezer Section:

- 4 Fixed White Door Bins
- 3 Wire Shelves
- 1 Tall Basket

### Available In:

- White and Black

## Top Mount Refrigerator Features



**Water Through-The-Door Dispenser**  
Slim-profile design makes it easy to fill containers of all sizes with chilled, filtered water. Easily accessible child-safe lock prevents unintentional activation.



**PureSource® Ice & Water Filtration System**  
Removes nearly all impurities (including chlorine and lead) and particulates for cleaner, better tasting water and ice.



**Never Clean™ Condenser**  
Under normal household use, condenser coils never require cleaning.



**Sliding SpillSafe™ Glass Shelves**  
Encased shelf catches and holds spills for easy cleanup and slides in and out for easy access.



**Humidity-Controlled Crispers**  
From leafy vegetables to skinned fruits, humidity controls maximize the shelf life of all produce.



**Clear Deli Drawer**  
Securely stores and maintains deli items at maximum freshness levels while allowing complete visibility and easy access.



**Clear Adjustable Door Bins with No-Slip Liners**  
Adjustable door bins offer maximum storage capacity with the convenience to lift and snap into place. The no-slip liners line the bottom of the bin and help prevent stored items from sliding.



**Tilt-Out Wire Door Bins**  
Store more in a smaller space. Wire construction securely stores small packages, allows for complete visibility and tilts out for easy access.



**Can Dispenser/Wine Rack**  
Dispenses your favorite canned beverages or cradles a wine bottle in the correct storage position.

# Frigidaire



## Professional Series®

**PHT219WH SM/KM**

20.6 Cubic Feet



### Refrigerator Section:

- UltraSoft™ Stainless Steel Doors
- UltraPro Stainless Steel Handles
- Color-Coordinated Silver Mist Finish Cabinet, Hinge Cover, Water Dispenser and Toe Grille
- Water Through-The-Door Dispenser
- Rear-Mounted PureSource® Ice & Water Filter
- 4 Half-Width Cantilever SpillSafe™ Glass Shelves (3 Sliding)
- 4 Adjustable Clear Gallon Door Bins (2 with No-Slip Liners)
- 1 Fixed White Door Bin
- Clear Dairy Door
- Clear Deli Drawer
- 2 Clear Crispers
- 2 Humidity Controls
- Mid-Mount Lighting
- White Can Dispenser/Wine Rack
- Never Clean™ Condenser

### Freezer Section:

- Freezer Light
- 1 Fixed Clear Door Bin
- 1 Tilt-Out Wire Bin
- 1 Full-Width Shelf
- Factory Ice Maker

### Available In:

- Stainless Steel/  
Silver Mist Finish



Also Available:

**PHT219H SM/KM**

20.6 Cubic Feet



(Does Not Include Water Through-The-Door Dispenser or PureSource® Ice & Water Filter)



## Gallery Series®

### GLHT217H S/K

20.6 Cubic Feet



#### Refrigerator Section:

- UltraSoft™ Stainless Steel Doors
- UltraSoft™ Black Handles
- 4 Half-Width Cantilever SpillSafe™ Glass Shelves (1 Sliding)
- 4 Adjustable Clear Gallon Door Bins (2 with No-Slip Liners)
- 1 Fixed White Door Bin
- Clear Dairy Door
- Clear Deli Drawer
- 2 Clear Crispers
- 2 Humidity Controls
- Mid-Mount Lighting
- Never Clean™ Condenser

#### Freezer Section:

- Freezer Light
- 1 Fixed Clear Door Bin
- 1 Tilt-Out Wire Bin
- 1 Full-Width Shelf
- Ice Trays/Bucket

#### Available In:

- Stainless Steel/Black



## Gallery Series®

### GLHT217H W/Q/B

20.6 Cubic Feet



#### Refrigerator Section:

- UltraSoft™ Doors
- UltraSoft™ Handles
- 4 Half-Width Cantilever SpillSafe™ Glass Shelves (1 Sliding)
- 4 Adjustable Clear Gallon Door Bins (2 with No-Slip Liners)
- 1 Fixed White Door Bin
- Clear Dairy Door
- Clear Deli Drawer
- 2 Clear Crispers
- 2 Humidity Controls
- Mid-Mount Lighting
- Never Clean™ Condenser

#### Freezer Section:

- Freezer Light
- 1 Fixed Clear Door Bin
- 1 Tilt-Out Wire Bin
- 1 Full-Width Shelf
- Ice Trays/Bucket

#### Available In:

- White, Bisque and Black



# Frigidaire



## Frigidaire® FRT1S6ES B/K 20.5 Cubic Feet

### Refrigerator Section:

- UltraSoft™ Stainless Steel Doors
- UltraSoft™ Black Handles
- 2 Sliding Full-Width SpillSafe™ Glass Shelves
- 3 Fixed White Door Bins (2 with Gallon Storage)
- Clear Dairy Door
- Clear Deli Drawer
- 2 Clear Crispers
- 2 Humidity Controls
- Never Clean™ Condenser

### Freezer Section:

- 2 Fixed White Door Bins
- 1 Full-Width Shelf
- Ice Trays/Bucket

### Available In:

- Stainless Steel/Black



## Frigidaire® FRT21S6A W/Q/B 20.5 Cubic Feet

### Refrigerator Section:

- UltraSoft™ Doors
- UltraSoft™ Handles
- 2 Sliding Full-Width SpillSafe™ Glass Shelves
- 3 Fixed White Door Bins (2 with Gallon Storage)
- Clear Dairy Door
- Clear Deli Drawer
- 2 Clear Crispers
- 2 Humidity Controls
- Never Clean™ Condenser

### Freezer Section:

- 2 Fixed White Door Bins
- 1 Full-Width Shelf
- Ice Trays/Bucket

### Available In:

- White, Bisque and Black





## Professional Series®

### PHT189WH SM/KM

18.3 Cubic Feet



#### Refrigerator Section:

- UltraSoft™ Stainless Steel Doors
- UltraPro Stainless Steel Handles
- Color-Coordinated Silver Mist Finish Cabinet, Hinge Cover, Water Dispenser and Toe Grille
- Water Through-The-Door Dispenser
- Rear-Mounted PureSource® Ice & Water Filter
- 4 Half-Width Cantilever SpillSafe™ Glass Shelves (3 Sliding)
- 4 Adjustable Clear Gallon Door Bins (2 with No-Slip Liners)
- 1 Fixed White Door Bin
- Clear Dairy Door
- Clear Deli Drawer
- 2 Clear Crispers
- 2 Humidity Controls
- Mid-Mount Lighting
- White Can Dispenser/Wine Rack
- Never Clean™ Condenser

#### Freezer Section:

- Freezer Light
- 1 Fixed Clear Door Bin
- 1 Tilt-Out Wire Bin
- 1 Full-Width Shelf
- Factory Ice Maker

#### Available In:

- Stainless Steel/  
Silver Mist Finish



Also Available:

### PHT189H SM/KM

18.3 Cubic Feet



(Does Not Include Water Through-The-Door Dispenser or PureSource® Ice & Water Filter)

# Frigidaire

## Gallery Series®

**GLHT188WH W/B**

18.3 Cubic Feet



### Refrigerator Section:

- UltraSoft™ Smooth Doors
- UltraSoft™ Handles
- Water Through-The-Door Dispenser
- Rear-Mounted PureSource® Ice & Water Filter
- 4 Half-Width Cantilever SpillSafe™ Glass Shelves (1 Sliding)
- 4 Adjustable Clear Gallon Door Bins (2 with No-Slip Liners)
- 1 Fixed White Door Bin
- Clear Dairy Door
- Clear Deli Drawer
- 2 Clear Crispers
- 2 Humidity Controls
- Mid-Mount Lighting
- Never Clean™ Condenser

### Freezer Section:

- Freezer Light
- 1 Fixed White Door Bin
- 1 Tilt-Out Wire Bin
- 1 Full-Width Shelf
- Factory Ice Maker

### Available In:

- White and Black







**Gallery Series®**  
**GLHT186H S/K**  
 18.3 Cubic Feet



**Refrigerator Section:**

- UltraSoft™ Stainless Steel Doors
- UltraSoft™ Black Handles
- 4 Half-Width Cantilever SpillSafe™ Shelves (1 Sliding)
- 4 Adjustable Clear Gallon Door Bins (2 with No-Slip Liners)
- 1 Fixed White Door Bin
- Clear Dairy Door
- Clear Deli Drawer
- 2 Clear Crispers
- 2 Humidity Controls
- Mid-Mount Lighting
- Never Clean™ Condenser

**Freezer Section:**

- Freezer Light
- 1 Fixed White Door Bin
- 1 Tilt-Out Wire Bin
- 1 Full-Width Shelf
- Ice Trays/Bucket

**Available In:**

- Stainless Steel/Black



**Gallery Series®**  
**GLHT186H W/Q/B**  
 18.3 Cubic Feet



**Refrigerator Section:**

- UltraSoft™ Doors
- UltraSoft™ Handles
- 4 Half-Width Cantilever SpillSafe™ Shelves (1 Sliding)
- 4 Adjustable Clear Gallon Door Bins (2 with No-Slip Liners)
- 1 Fixed White Door Bin
- Clear Dairy Door
- Clear Deli Drawer
- 2 Clear Crispers
- 2 Humidity Controls
- Mid-Mount Lighting
- Never Clean™ Condenser

**Freezer Section:**

- Freezer Light
- 1 Fixed White Door Bin
- 1 Tilt-Out Wire Bin
- 1 Full-Width Shelf
- Ice Trays/Bucket

**Available In:**

- White, Bisque and Black



# Frigidaire



## Frigidaire® FRT18IS6C W/Q/B

18.2 Cubic Feet

### Refrigerator Section:

- UltraSoft™ Doors
- UltraSoft™ Handles
- 2 Sliding Full-Width SpillSafe™ Glass Shelves
- 3 Fixed White Door Bins (2 with Gallon Storage)
- Clear Dairy Door
- Clear Deli Drawer
- 2 Clear Crispers
- 2 Humidity Controls
- Never Clean™ Condenser

### Freezer Section:

- 2 Fixed White Door Bins
- 1 Full-Width Shelf
- Factory Ice Maker

### Available In:

- White, Bisque and Black



## Frigidaire® FRT8S6E S/K

18.2 Cubic Feet

### Refrigerator Section:

- UltraSoft™ Stainless Steel Doors
- UltraSoft™ Black Handles
- 2 Sliding Full-Width SpillSafe™ Glass Shelves
- 3 Fixed White Door Bins (2 with Gallon Storage)
- Clear Dairy Door
- Clear Deli Drawer
- 2 Clear Crispers
- 2 Humidity Controls
- Never Clean™ Condenser

### Freezer Section:

- 2 Fixed White Door Bins
- 1 Full-Width Shelf
- Ice Trays

### Available In:

- Stainless Steel/Black





**Frigidaire®**  
**FRT8S6E MB**  
 18.2 Cubic Feet

**Refrigerator Section:**

- UltraSoft™ Silver Mist Finish Doors
- UltraSoft™ Black Handles
- 2 Sliding Full-Width SpillSafe™ Glass Shelves
- 3 Fixed White Door Bins (2 with Gallon Storage)
- Clear Dairy Door
- Clear Deli Drawer
- 2 Clear Crispers
- 2 Humidity Controls
- Never Clean™ Condenser

**Freezer Section:**

- 2 Fixed White Door Bins
- 1 Full-Width Shelf
- Ice Trays

**Available In:**

- Silver Mist Finish/Black



**Frigidaire®**  
**FRT18S6A W/Q/B**  
 18.2 Cubic Feet

**Refrigerator Section:**

- UltraSoft™ Doors
- UltraSoft™ Handles
- 2 Sliding Full-Width SpillSafe™ Glass Shelves
- 3 Fixed White Door Bins (2 with Gallon Storage)
- Clear Dairy Door
- Clear Deli Drawer
- 2 Clear Crispers
- 2 Humidity Controls
- Never Clean™ Condenser

**Freezer Section:**

- 2 Fixed White Door Bins
- 1 Full-Width Shelf
- Ice Trays

**Available In:**

- White, Bisque and Black



# Frigidaire



## Frigidaire® FRT8G7H W/Q/B

18.2 Cubic Feet

### Refrigerator Section:

- UltraSoft™ Doors
- 2 Sliding Glass Shelves
- 3 Fixed White Door Racks (1 with Gallon Storage)
- Clear Dairy Door
- Clear Deli Drawer
- 2 Clear Crispers
- 1 Humidity Control
- Static Condenser

### Freezer Section:

- 2 Fixed White Door Racks
- 1 Full-Width Shelf
- Ice Trays

### Available In:

- White, Bisque and Black



## Frigidaire® FRT8B5H W/Q

18.2 Cubic Feet

### Refrigerator Section:

- UltraSoft™ Doors
- 2 Sliding Wire Shelves
- 3 Fixed White Door Racks (1 with Gallon Storage)
- Clear Dairy Door
- 2 Clear Crispers
- 1 Humidity Control
- Static Condenser

### Freezer Section:

- 2 Fixed White Door Racks
- 1 Half-Width Shelf
- Factory Ice Maker

### Available In:

- White and Bisque

### Also Available:

## FRT8B5H W/Q/B/Z

18.2 Cubic Feet

(Does Not Include  
Factory Ice Maker)

- White, Bisque and Black





**Frigidaire®**  
**FRT17G5CS B/K**  
 16.5 Cubic Feet

**Refrigerator Section:**

- Stainless Steel Doors
- Black Handles
- 2 Full-Width Sliding Glass Shelves
- 2 Fixed White Door Bins with Gallon Storage
- 1 Fixed White Door Rack
- Clear Dairy Door
- Clear Deli Drawer
- 2 Clear Crispers
- 2 Humidity Controls
- Never Clean™ Condenser

**Freezer Section:**

- 2 Fixed White Door Racks
- 1 Full-Width Shelf
- Ice Trays

**Available In:**

- Stainless Steel/Black



**Frigidaire®**  
**FRT17G4B W/Q**  
 16.5 Cubic Feet

**Refrigerator Section:**

- 2 Sliding Glass Shelves
- 2 Fixed White Door Bins with Gallon Storage
- 1 Fixed White Door Rack
- Clear Dairy Door
- Clear Deli Drawer
- 2 Clear Crispers
- 2 Humidity Controls
- Static Condenser

**Freezer Section:**

- 2 Fixed White Door Racks
- 1 Full-Width Shelf

**Available In:**

- White and Bisque



# Frigidaire



## Frigidaire® FRT17B3A W/Q/Z

16.5 Cubic Feet

### Refrigerator Section:

- 2 Sliding Wire Shelves
- 3 Fixed White Door Racks (1 with Gallon Storage)
- White Dairy Door
- 2 White Crispers
- Static Condenser

### Freezer Section:

- 2 Fixed White Door Racks
- 1 Half-Width Shelf

### Available In:

- White and Bisque



## Frigidaire® FRT15G4B W

14.8 Cubic Feet

### Refrigerator Section:

- 2 Sliding Glass Shelves
- 2-1/2 Fixed White Door Racks (1 with Gallon Storage)
- Clear Dairy Door
- Clear Deli Drawer
- 2 Clear Crispers
- 2 Humidity Controls
- Static Condenser

### Freezer Section:

- 2 Fixed White Door Racks
- 1 Full-Width Shelf

### Available In:

- White





**Frigidaire®**  
**FRT15B3A W/Q**

14.8 Cubic Feet

**Refrigerator Section:**

- 2 Sliding Wire Shelves
- 2-1/2 Fixed White Door Racks (1 with Gallon Storage)
- White Dairy Door
- 2 White Crispers
- Static Condenser

**Freezer Section:**

- 2 Fixed White Door Racks
- 1 Half-Width Shelf

**Available In:**

- White and Bisque



**Frigidaire®**  
**FRT15A2D W/Z**

14.8 Cubic Feet

**Refrigerator Section:**

- 2 Sliding Wire Shelves
- 2-1/2 Fixed White Door Racks (1 with Gallon Storage)
- White Dairy Door
- White Full-Width Crisper
- Static Condenser

**Freezer Section:**

- 2 Fixed White Door Racks

**Available In:**

- White



# Frigidaire



Frigidaire®  
All Refrigerator  
**FRU17G4J W**  
16.7 Cubic Feet

- Operates in Ambient Temperature Environments as Low as 10° F
- Frost Free
- Interior Light
- 3 Fixed Glass Shelves
- 1 Fixed Wire Shelf
- 2 Slide-Out Wire Baskets
- 4 Fixed White Door Bins
- 1 Tall Tilt-Out Door Bin

**Available In:**

- White



Frigidaire®  
All Refrigerator  
**FRU17B2J W**  
16.7 Cubic Feet

- Operates in Ambient Temperature Environments as Low as 10° F
- Frost Free
- Interior Light
- 2 Adjustable Wire Shelves
- 2 Fixed Wire Shelves
- 5 Fixed White Door Racks (1 Tall Storage)
- 1 Trivet

**Available In:**

- White





## Beverage Center Features



**Dispensing Kit**  
Everything you need to tap into your favorite kegged beverage including tap, regulator, faucet, hoses and CO<sub>2</sub> canister.



**Adjustable Auxiliary Shelves**  
Shelving system makes it easy to customize your Beverage Center to accommodate glassware and other beverages.



**Reinforced Cabinet Structure**  
Structure is reinforced to accommodate kegs up to 16 gallons.



**Sliding Storage Baskets**  
Two sliding baskets provide convenient, high-visibility storage for fruits, garnishes and packaged goods.



**Flexible Storage**  
Side racks are ideal for storing cans, wine bottles or two-liter containers. When the keg space is not being used, three optional shelves provide additional food storage.



**Heavy-Duty Caster Kit**  
With the addition of the optional heavy-duty casters, the Beverage Center becomes mobile and moves wherever the party is. Casters lock in place for a stationary placement.

## All-Freezer / All-Refrigerator Duo Features



**Tilt-Out Wire Door Bins**  
Store more in a smaller space. Wire construction securely stores small packages, allows for complete visibility and tilts out for easy access.



**Full-Access Sliding Storage Baskets**  
Organizing the big stuff is easy. Wire construction securely stores large packages while providing complete visibility.



**Door Storage**  
Clear, adjustable bins and full-width gallon bin offer maximum storage. Shelves easily lift out and snap into a new position with one hand.

# Frigidaire



**Optional Trim Kits**  
To create a more built-in look, optional trim kits are available for a stand-alone refrigerator, stand-alone freezer, or for both units together in a side-by-side configuration.



## Professional Series®

All-Freezer / All-Refrigerator Duo

**PLFU1778E S / PLRU1778E S**

33.7 Total Cubic Feet

### All Freezer:

- EasyCare™ Genuine Stainless Steel Door
- UltraPro Stainless Steel Handle
- 2 Full-Width Cantilever Glass Shelves
- 1 Full-Width Sliding Glass Shelf
- 2 Full-Access Sliding Storage Baskets
- 2 Tilt-Out Wire Door Bins
- 3 Full-Width Fixed White Door Bins
- Mid-Level Lighting
- Ice Maker-Ready (IM501)
- 4 Adjustable Leg Levelers
- Dynamic Condenser Allows for Built-In Applications
- Optional Trim Kit Available (ALLFRZKIT)

### All Refrigerator:

- EasyCare™ Genuine Stainless Steel Door
- UltraPro Stainless Steel Handle
- 3 Full-Width Cantilever Glass Shelves
- 1 Full-Width Fixed Glass Shelf
- 4 Adjustable Clear Door Bins
- 1 Full-Width Fixed White Gallon Door Bin
- Clear Dairy Door
- Clear Deli Drawer
- 2 Clear Crispers
- 1 Humidity Control
- Mid-Level Lighting
- Tall Bottle Retainer
- Tall Bottle Caddy
- 4 Adjustable Leg Levelers
- Dynamic Condenser Allows for Built-In Applications
- Optional Trim Kit Available (ALLREFKIT)

Optional Duo Trim Kit Available (DUOTRIMKIT)



**Professional Series®**  
Beverage Center  
**PLKU1267D S**

- Stainless Steel Door
- Dispensing Kit Included
- 2 Auxiliary Shelves for Other Beverages and Glassware
- Holds Up To 16 Gallon Keg
- Optional Caster Kit Available (297027300)



Shown with optional casters.



**Frigidaire®**  
Beverage Center II  
**FRTB7B4E MB**  
16.5 Cubic Feet

**Refrigerator Section:**

- Silver Mist Door Finish
- Beverage Dispenser
- Large Drip Tray with Drain
- Optional Drip Tray Hose Kit Available (5304451963)
- Dispensing Kit Included
- Commercial Quality Keg Tapper
- Accommodates Up To a 16-Gallon Keg
- 1 Adjustable Wire Shelf
- Converts to a Refrigerator When Beverage Dispensing is Not Required
- Unit can hold up to 4 Fresh Food Shelves (Sold Separately 241667701)
- 2 Fixed White Door Racks (1 with Gallon Storage)

- 5-Level Fixed Wire Utility Shelf for Canned Beverages and Wine Bottle Storage
- 2 Sliding Wire Baskets
- Optional Caster Kit Available (5304451343)

**Freezer Section:**

- 2 Fixed White Door Racks
- 1 Standard Full-Width Wire Shelf
- Ice Maker Ready



Shown with optional casters.





Professional Series® products

Electric Range PLEFZ398EC  
Vent Hood PL36WC50EC  
Dishwasher PLD4555RFC  
Refrigerator PHSC39EHSS

# Frigidaire

## Accessories



### Ice Maker

Now, you can add ice-making capabilities to your top mount refrigerator. Fits all models manufactured after April 2001. **IM115**



### Ice Maker

Allows you to add ice-making capabilities to the all-freezer duo model PLFU1778E. **IM501**



### Ice Tray

Ice Trays are designed to be stackable to save space and are flexible for easy release. **215667501**

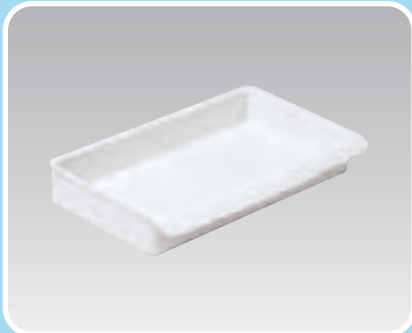

### Butter Dish

Great for storing and serving sticks of butter. It's dishwasher safe. **5308000716**

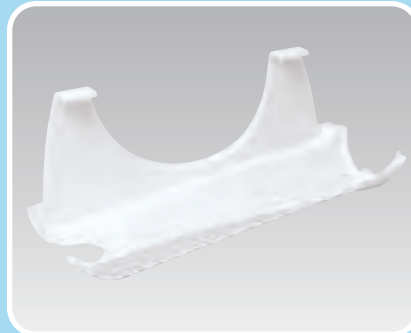

### VersaShelf

Available in white or clear plastic, the VersaShelf hooks onto cantilevered shelving for small item storage that doesn't consume valuable shelf space. **240424501 - White**  
**240424502 - Clear**

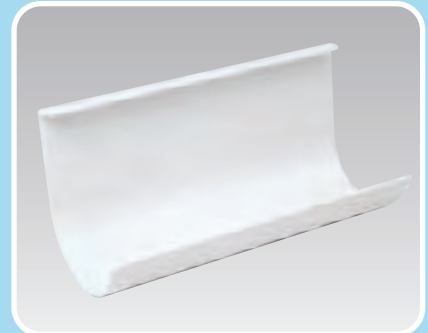

### Wine Rack

Available in white or clear plastic, our Wine Rack hooks onto cantilevered shelving for storage that doesn't consume valuable shelf space. **5304402116 - White**  
**5303295947 - Clear**



### PureSource 2® Ice & Water Replacement Filter Cartridge

Twin carbon block filter cassette effectively protects against lead, chlorine, cysts and particulates. The no-spill cassette can be replaced with the push of a button every 400 gallons (6 to 9 months). **WF2CB**



### PureSource Plus® Enhanced Ice & Water Replacement Filter Cartridge

Provides clean, fresh-tasting ice and water while reducing contaminants. This filter has been strenuously tested and certified by NSF International. Fits all Frigidaire® filter-equipped models manufactured before 2001 energy-compliant regulations. **WFCB**



### PureSource® Ice & Water Replacement Filter Cartridge

Provides clean, fresh-tasting ice and water. Removes nearly all impurities, including chlorine and particulates. Fits all Frigidaire® rear filter-equipped models manufactured after April 2001. **WFICB**



**Kitchen Care Kit**  
 Everything you need to keep your kitchen appliances looking new, including nonabrasive kitchen cleaners, microfiber sponges and scraper. **5304436288**



**16-Oz. Stainless Steel Appliance Cleaner**  
 Preserve the look of your stainless steel appliances for years to come. Provides protection from fingerprints and smudges. **5304433275**



**Universal Refrigerator/Freezer Deodorizer**  
 Prevent distasteful odors from taking over your refrigerator or freezer. Simply place in the area you wish to deodorize and let it do the rest! **78956**

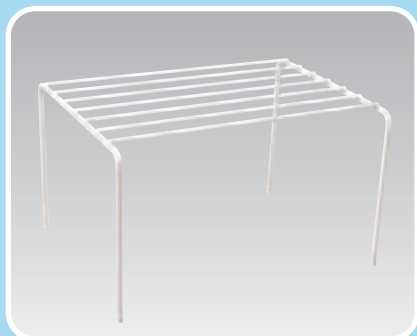

**Freezer Shelves**  
 Maximize storage space in your top mount freezer while maintaining an organized look. **ISK18 - 18"** **ISK21 - 21"**



**Counter-Depth Refrigerator Collar Kits**  
 Give your counter-depth refrigerator that "built-in" look with a color-coordinated collar kit, available in three colors to match your kitchen's décor. **CK23CDW - White**  
**CK23CDB - Black** **CK23CDS - Stainless Steel**



**Panel-Ready Refrigerator Door Panel Kits**  
 Counter-depth refrigerator model GHSC39ETH is designed to be panel-kit ready and accept color-coordinated door panels, available in three colors to match your kitchen's décor. **PK23CDW - White** **PK23CDB - Black**  
**PK23CDS - Stainless Steel**



**Ice Cream Shelf**  
 Our Ice Cream Shelf fits in the unused space above the ice maker and keeps ice cream at the optimum serving temperature. **240342902**

## COUNTER-DEPTH REFRIGERATORS

Model	PHSC39EH	GHSC39ETHS	GHSC39ETH	GHSC39EH	FSC23F7HSB	FSC23F7H	FSC23R5D
Series	Professional	Gallery	Gallery	Gallery	Frigidaire	Frigidaire	Frigidaire
ENERGY STAR®							
<b>Capacities</b>							
Total Capacity (Cu. Ft.)	22.6	22.6	22.6	22.6	22.6	22.6	22.6
Fresh Food Volume (Cu. Ft.)	14.06	14.06	14.06	14.06	14.07	14.07	14.06
Freezer Volume (Cu. Ft.)	8.51	8.51	8.51	8.51	8.53	8.53	8.58
Total Shelf Area (Sq. Ft.)	23.7	23.7	23.7	23.7	23.3	23.3	22.7
<b>Exterior Conveniences</b>							
Stainless Look Finish Cabinet	.	.	.	.	.	.	.
Door Panel-Kit Ready*	.	.	.	.	.	.	.
Door Hinge Cover	Full Width	Standard	Standard	Full Width	Full Width	Full Width	Standard
Door Handle	UltraPro Stainless Steel	Full-Length Stainless Steel	Full Length Color-Coordinated	UltraPro Color-Coordinated Steel	UltraPro Stainless Steel	UltraPro Color-Coordinated Steel	UltraSoft™
Dispenser	7 Button	7 Button	7 Button	7 Button	6 Button	6 Button	4 Button
Water	.	.	.	.	.	.	.
Cubes	.	.	.	.	.	.	.
Crushed	.	.	.	.	.	.	.
Extra Ice	.	.	.	.	.	.	.
Extreme Freeze	.	.	.	.	.	.	.
Lock	.	.	.	.	.	.	.
Illuminated Dispenser Paddles	.	.	.	.	.	.	.
<b>Interior Conveniences</b>							
Fan-Forced Air Filter w/ Indicator	.	.	.	.	.	.	.
Water Filter Location	Front	Front	Front	Front	Front	Front	Rear
Water Filter Type	PureSource 2®	PureSource 2®	PureSource 2®	PureSource 2®	PureSource 2®	PureSource 2®	PureSource®
Water Filter Change Light	.	.	.	.	.	.	.
Temperature Alarm	.	.	.	.	.	.	.
Door Ajar Alarm	.	.	.	.	.	.	.
Power Failure Alarm	.	.	.	.	.	.	.
Lighting	Transition	Transition	Transition	Transition	Dual Level	Dual Level	Dual Level
SmartFit™ Shelf	1	1	1	1			
Sliding SpillSafe™ Shelf	1	1	1	1	2	2	
SpillSafe™ Shelf	1	1	1	1	1	1	3
Adjustable Bins	2 Clear	2 Clear	2 Clear	2 Clear	2 Clear	2 Clear	2 White
Fixed Bins	2 Clear	2 Clear	2 Clear	2 Clear	2 Clear	2 Clear	2 White
No-Slip Liners	3	3	3	3	3	3	
Dairy Door	Clear	Clear	Clear	Clear	Clear	Clear	Clear
Fresh Lok™ Meatkeeper	Clear	Clear	Clear	Clear	Clear	Clear	Clear
Crispers	Clear	Clear	Clear	Clear	Clear	Clear	Clear
Humidity Controls	3	3	3	3	2	2	1
Wine Rack	Clear	Clear	Clear	Clear	Clear	Clear	Clear
In-Door Can Rack	Clear	Clear	Clear	Clear	Clear	Clear	White
<b>Freezer Conveniences</b>							
Door Bins	2 Clear	2 Clear	2 Clear	2 Clear	3 Clear	3 Clear	4 White
Shelves	2 Glass	2 Glass	2 Glass	2 Glass	2 Glass	2 Glass	3 Wire
Tilt-Out Wire Door Shelves	2	2	2	2	1	1	
Full-Extension Basket	1	1	1	1			
Tall Basket	1	1	1	1	2	2	1
Regular Basket	1	1	1	1			
Space-Saver Shelf	.	.	.	.	.	.	.
<b>Color/UPC (0-12505)</b>							
White (W)			69418-9			69412-7	68812-6
Pearl White (PW)				69415-8			
Black (B)			69419-6			69413-4	68813-3
Pearl Black (PB)				69416-5			
Stainless Steel/Black (SB)					69414-1		68990-1
Stainless Steel (SS)	69417-2						
Stainless Steel (S)		69420-2					
<b>Specifications</b>							
Product Weight (Approx.)	300 Lbs.	300 Lbs.	300 Lbs.	300 Lbs.	300 Lbs.	300 Lbs.	300 Lbs.
Shipping Weight (Approx.)	325 Lbs.	325 Lbs.	325 Lbs.	325 Lbs.	325 Lbs.	325 Lbs.	325 Lbs.

\*Order Optional Door Panel Kit or use with 1/4" Custom Cabinet Front.

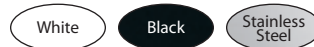

## OPTIONAL ACCESSORY KITS

Door Panel Kits		Collar Kits	
White Acrylic	(PK23CDW)	White	(CK23CDW)
Black Acrylic	(PK23CDB)	Black	(CK23CDB)
Stainless Steel	(PK23CDS)	Stainless Steel	(CK23CDS)

## COLLAR KIT INSTALLATION

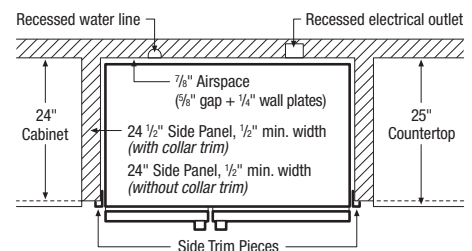
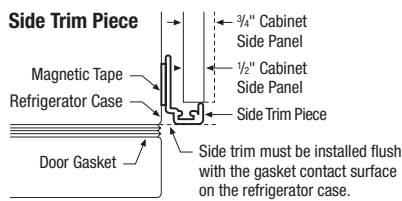
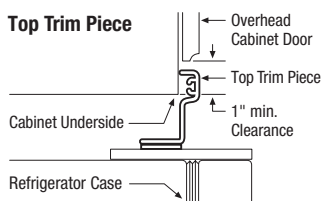

## Cutout Dimensions

Standard	With Collar Trim Kit
(A) 70 1/4"	(A) 70 1/4"
(B) 36"	(B) 36 1/8"
(C) 24"	(C) 24 1/2"

## COUNTER-DEPTH REFRIGERATOR INSTALLATION

The following dimension and cutout information is for planning purposes only. For complete installation details consult manual packed with product, or download manual at Customer Service, online at [frigidaire.com](http://frigidaire.com).

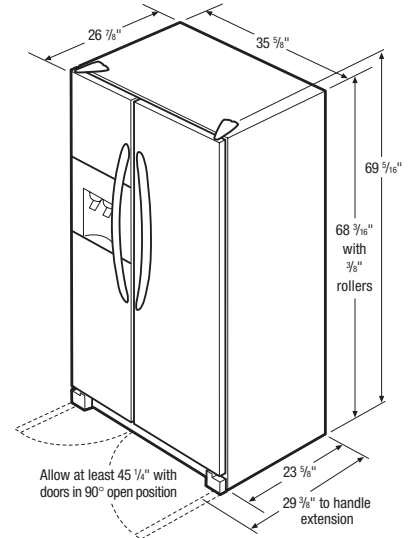

Allow sufficient clearance on hinge side of refrigerator when installing next to a wall where handle may make contact.

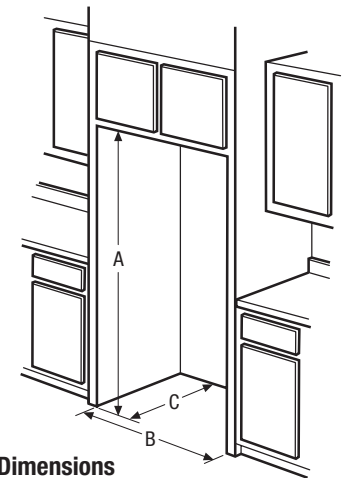



## COUNTER-DEPTH REFRIGERATOR DOOR PANEL INSTALLATION

Consult installation instructions packed with individual products for complete details.

The following instructions outline the procedure to install Door Panel Kits or custom panels on your Frigidaire® Counter-Depth Refrigerator Panel-Kit Ready models.

### Door Panel Kits Available:

**White** (PK23CDW), **Black** (PK23CDB) or **Stainless Steel** (PK23CDS).

### For Custom Door Panels:

Order your own custom door panels to match cabinetry or other décor. Panels up to 1/4" thick will fit door frames with no special preparation. Local shop-built or custom cabinet supplier may fabricate custom 1/4" panels. Refer to drawings below for panel dimensions and specifications. Edges must be routed to 1/4".

**Note:** When installing custom panels less than 1/4", insert spacer panel behind door panel for proper fit (spacer panel supplied with Door Panel Kit). Combined thickness of panels must total 1/4".

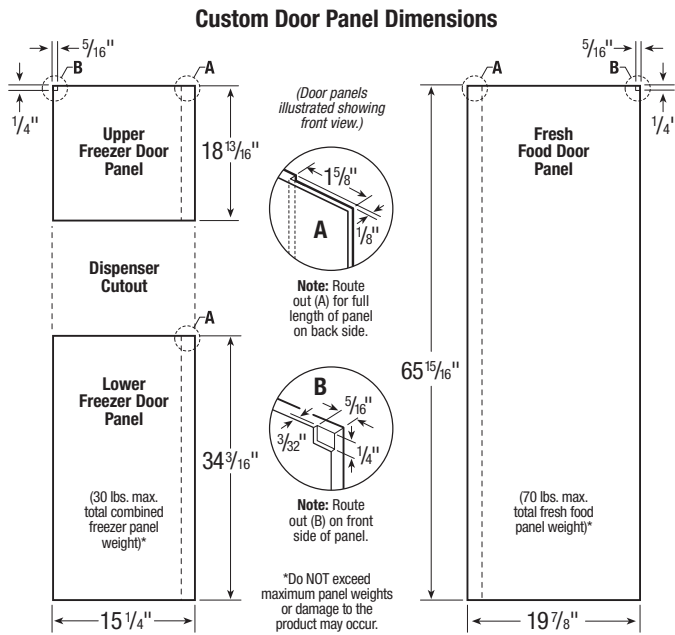

### INSTALLATION INSTRUCTIONS

Read each step thoroughly before proceeding.

**Tools:** #2 Phillips Screwdriver

#### Procedure:

**Step 1 – Loosen top trim on freezer and fresh food doors.**

**Step 2 – Remove side trim.**

Swing bottom of side trim outward away from door to break magnetic attachment. Lower side trim to pull free of top trim.

**Step 3 – Insert panels.**

Remove protective film from panels before insertion.

**Upper Freezer Panel and Fresh Food Panel –** Cutout notch in panel is positioned to upper outside of door. Lift top trim up 1/4" and carefully push upper freezer panel in until it slides into slot behind door handle.

**Lower Freezer Panel –** Carefully push panel in until it slides into slot behind door handle.

**Step 4 – Install side trim.**







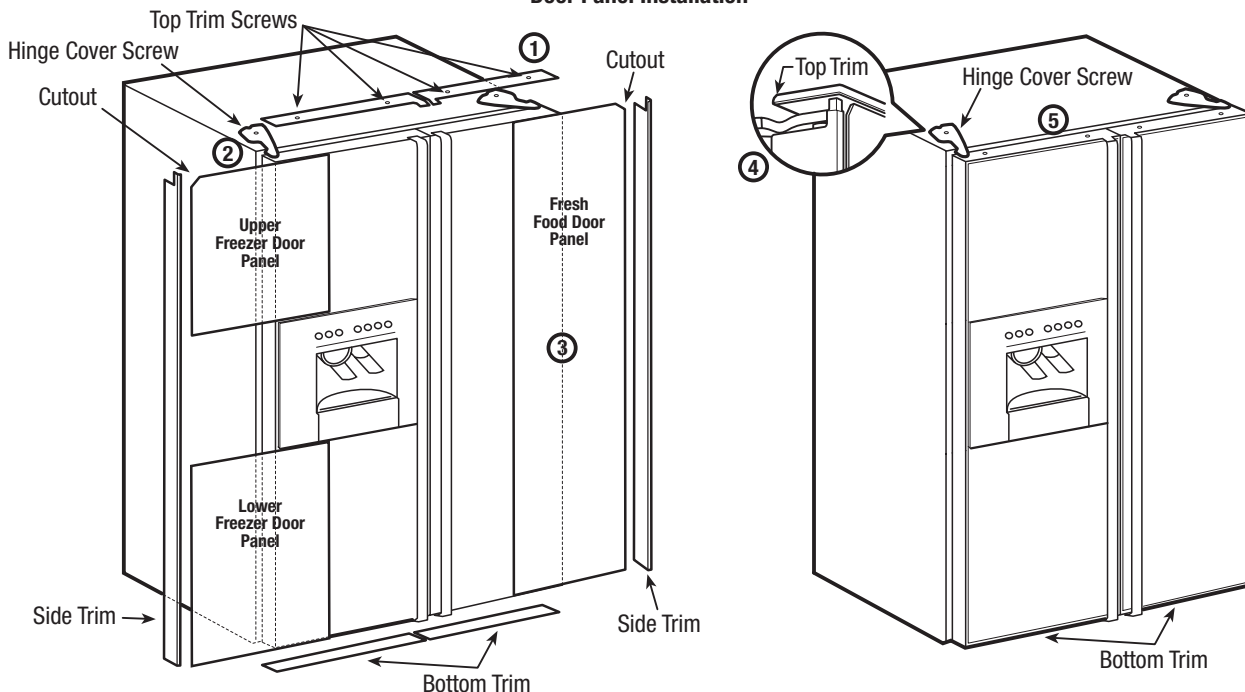



Slip upper front corner of side trim under top trim and swing into position. Make sure trim seats behind panel and in front of Ice & Water dispenser. Magnetic attraction will hold trim in place.

**Step 5 – Tighten screws on top trim.**



### Door Panel Installation



## SIDE-BY-SIDE REFRIGERATORS

Model	PHS69EH	PHS67EH	PHS39EH	PHS37EH	GLHS69EHSB	GLHS39EHSB	GLHS69EH	GLHS39EH	GLHS65EH	GLHS35EH
Series	Professional	Professional	Professional	Professional	Gallery	Gallery	Gallery	Gallery	Gallery	Gallery
ENERGY STAR®										
<b>Capacities</b>										
Total Capacity (Cu. Ft.)	26.0	26.0	22.6	22.6	26.0	22.6	26.0	22.6	26.0	22.6
Fresh Food Volume (Cu. Ft.)	16.48	16.48	14.22	14.22	16.48	14.22	16.48	14.22	16.48	14.22
Freezer Volume (Cu. Ft.)	9.48	9.48	8.33	8.33	9.48	8.33	9.48	8.33	9.48	8.33
Total Shelf Area (Sq. Ft.)	26.9	26.9	22.8	22.8	26.9	22.8	26.9	22.8	26.9	22.8
<b>Exterior Conveniences</b>										
Stainless Look Finish Cabinet	-	-	-	-	-	-	-	-	Standard	Standard
Door Hinge Cover	Full Width	Full Width	Full Width	Full Width	Full Width	Full Width	Full Width	Full Width	-	-
Door Handle	UltraPro Stainless Steel	UltraPro Stainless Steel	UltraPro Stainless Steel	UltraPro Stainless Steel	UltraPro Stainless Steel	UltraPro Stainless Steel	UltraPro Color-Coordinated Steel	UltraPro Color-Coordinated Steel	UltraSoft™	UltraSoft™
Dispenser	7 Button	5 Button	7 Button	5 Button	7 Button	7 Button	7 Button	7 Button	5 Button	5 Button
Water	•	•	•	•	•	•	•	•	•	•
Cubes	•	•	•	•	•	•	•	•	•	•
Crushed	•	•	•	•	•	•	•	•	•	•
Extra Ice	•	•	•	•	•	•	•	•	•	•
Extreme Freeze	•	•	•	•	•	•	•	•	•	•
Lock	•	•	•	•	•	•	•	•	•	•
Illuminated Dispenser Paddles	•	•	•	•	•	•	•	•	•	•
<b>Interior Conveniences</b>										
Fan-Forced Air Filterw/Indicator	-	-	-	-	-	-	-	-	-	-
Water Filter Location	Front	Front	Front	Front	Front	Front	Front	Front	Front	Front
Water Filter Type	PureSource 2®	PureSource 2®	PureSource 2®	PureSource 2®	PureSource 2®	PureSource 2®	PureSource 2®	PureSource 2®	PureSource 2®	PureSource 2®
Water Filter Change Light	•	•	•	•	•	•	•	•	•	•
Electronic Temperature Control	Digital	Digital	Digital	Digital	Digital	Digital	Digital	Digital	Digital	Digital
Door Ajar Alarm	•	•	•	•	•	•	•	•	•	•
Lighting	Transition	Dual Level	Transition	Dual Level	Tri Level	Tri Level	Tri Level	Tri Level	Dual Level	Dual Level
SmartFit™ Shelf	1	-	1	-	-	-	-	-	-	-
Sliding SpillSafe™ Shelf	1	1	1	1	1	1	1	1	-	-
SpillSafe™ Shelf	1	2	1	2	2	2	2	2	3	3
Adjustable Bins	3 Clear	2 Clear	3 Clear	2 Clear	3 Clear	3 Clear	3 Clear	3 Clear	2 Clear	2 Clear
Fixed Bins	2 Clear	2 Clear	2 Clear	2 Clear	2 Clear	2 Clear	2 Clear	2 Clear	2 Clear	2 Clear
No-Slip Liners	2	2	2	2	2	2	2	2	2	2
Dairy Door	Clear	Clear	Clear	Clear	Clear	Clear	Clear	Clear	Clear	Clear
Fresh Lok™ Meatkeeper/Deli Drawer	Clear	Clear	Clear	Clear	Clear	Clear	Clear	Clear	Clear	Clear
Crispers/Humidity Controls	Clear/3	Clear/2	Clear/2	Clear/2	Clear/2	Clear/2	Clear/2	Clear/2	Clear/2	Clear/2
Can Dispenser/Wine Rack	White	-	White	White	White	White	White	White	-	-
<b>Freezer Conveniences</b>										
Door Bins	5	5	5	5	5	5	5	5	4	4
Shelves	2 Glass	2 Glass	2 Glass	2 Glass	2 Glass	2 Glass	2 Glass	2 Glass	3 Wire	3 Wire
Tilt-Out Wire Door Shelves	3	-	3	-	1	1	1	1	-	-
Full-Extension Basket	1	-	1	-	-	-	-	-	-	-
Tall Basket	1	2	1	2	2	2	2	2	1	1
Regular Basket	1	-	1	-	-	-	-	-	-	-
Space-Saver Shelf	•	•	•	•	•	•	•	•	•	•
Pizza Rack	•	•	•	•	•	•	•	•	•	•
<b>Color/UPC (0-12505)</b>										
White (W)	-	-	-	-	-	-	69389-2	69404-2	69382-3	69422-6
Pearl White (PW)	-	-	-	-	-	-	69392-2	69407-3	-	-
Bisque (Q)	-	-	-	-	-	-	-	-	-	-
Black (B)	-	-	-	-	-	-	69391-5	69405-9	69384-7	69423-3
Pearl Black (PB)	-	-	-	-	-	-	69393-9	69408-0	-	-
Stainless Steel/Black (SB)	-	69395-3	-	69410-3	69394-6	69409-7	-	-	69421-9	69424-0
Stainless Steel (SS)	69396-0	-	69411-0	-	-	-	-	-	-	-
Silver Mist/Black (MB)	-	-	-	-	-	-	-	-	-	-
<b>Dimensions</b>										
A-Cabinet Height	68-1/4"	68-1/4"	68-1/4"	68-1/4"	68-1/4"	68-1/4"	68-1/4"	68-1/4"	68-1/4"	68-1/4"
B-Total Height (with Hinge Covers)	69-3/8"	69-3/8"	69-3/8"	69-3/8"	69-3/8"	69-3/8"	69-3/8"	69-3/8"	69-3/8"	69-3/8"
C-Cabinet Width	35-5/8"	35-5/8"	32-5/8"	32-5/8"	35-5/8"	32-5/8"	35-5/8"	32-5/8"	35-5/8"	32-5/8"
D-Cabinet Depth	28-1/2"	28-1/2"	28-1/2"	28-1/2"	28-1/2"	28-1/2"	28-1/2"	28-1/2"	28-1/2"	28-1/2"
E-Depth (including Door)	31-3/4"	31-3/4"	31-3/4"	31-3/4"	31-3/4"	31-3/4"	31-3/4"	31-3/4"	31-3/4"	31-3/4"
F-Total Depth (with Handles)	34-3/8"	34-3/8"	34-3/8"	34-3/8"	34-3/8"	34-3/8"	34-3/8"	34-3/8"	34-1/8"	34-3/8"
G-Total Depth (with Door 90° Open)	50"	50"	48"	48"	50"	48"	50"	48"	50"	48"
Shipping Weight (Approx.)	300 Lbs.	300 Lbs.	285 Lbs.	285 Lbs.	300 Lbs.	285 Lbs.	300 Lbs.	285 Lbs.	300 Lbs.	285 Lbs.



Model	FRS6HR5H	FRS3HR5H	FRS6HR4H
Series	Frigidaire	Frigidaire	Frigidaire
ENERGY STAR®			
<b>Capacities</b>			
Total Capacity (Cu. Ft.)	26.0	22.6	26.0
Fresh Food Volume (Cu. Ft.)	16.46	14.22	16.46
Freezer Volume (Cu. Ft.)	9.54	8.33	9.54
Total Shelf Area (Sq. Ft.)	24.5	22.8	24.5
<b>Exterior Conveniences</b>			
Door Hinge Cover	Standard	Standard	Standard
Stainless Look Finish Cabinet			
Door Handle	UltraSoft™	UltraSoft™	Straight
Dispenser	4 Button	4 Button	4 Button
Water	•	•	•
Cubes	•	•	•
Crushed	•	•	•
Extra Ice			
Extreme Freeze			
Lock			
Illuminated Dispenser Paddles			
<b>Interior Conveniences</b>			
Fan-Forced Air Filterw/Indicator			
Water Filter Location	Rear	Rear	Rear
Water Filter Type	PureSource®	PureSource®	PureSource®
Water Filter Change Light			
Electronic Temperature Control	Electronic 1-9	Electronic 1-9	Electromechanical
Door Ajar Alarm	•	•	
Lighting			
SmartFit™ Shelf			
Sliding SpillSafe™ Shelf			
SpillSafe™ Shelf	3	3	3
Adjustable Bins	2 Clear	2 Clear	2 White
Fixed Bins	2 Clear	2 Clear	2 White
No-Slip Liners			
Dairy Door	Clear	Clear	Clear
Fresh Lok™ Meatkeeper/Deli Drawer	Clear	Clear	
Crispers/Humidity Controls	Clear/1	Clear/1	Clear/0
Can Dispenser/Wine Rack			
<b>Freezer Conveniences</b>			
Door Bins	4	4	4
Shelves	3 Wire	3 Wire	3 Wire
Tilt-Out Wire Door Shelves			
Full-Extension Basket			
Tall Basket	1	1	1
Regular Basket			
Space-Saver Shelf			
Pizza Rack			
<b>Color / UPC (0-12505)</b>			
White (W)	69377-9	69397-7	69375-5
Pearl White (PW)			
Bisque (Q)	69378-6	69398-4	
Black (B)	69379-3	69399-1	69376-2
Pearl Black (PB)			
Stainless Steel/Black (SB)	69381-6		
Stainless Steel (SS)			
Silver Mist/Black (MB)	69380-9	69400-4	
<b>Dimensions</b>			
A- Cabinet Height	68-1/4"	68-1/4"	68-1/4"
B- Total Height (with Hinge Covers)	69-3/8"	69-3/8"	69-3/8"
C- Cabinet Width	35-5/8"	32-5/8"	35-5/8"
D- Cabinet Depth	28-1/2"	28-1/2"	28-1/2"
E- Depth (including Door)	31-3/4"	31-3/4"	31-3/4"
F- Total Depth (with Handles)	34-1/8"	34-3/8"	33-7/8"
G- Total Depth (with Door 90° Open)	50"	48"	50"
Shipping Weight (Approx.)	300 Lbs.	285 Lbs.	300 Lbs.



## SIDE-BY-SIDE REFRIGERATOR INSTALLATION

The following dimension and cutout information is for planning purposes only. For complete installation details consult manual packed with product, or download manual at Customer Service, online at [frigidaire.com](http://frigidaire.com).

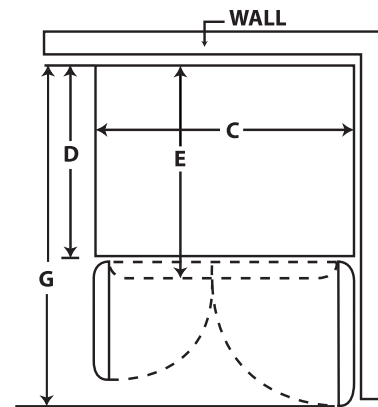
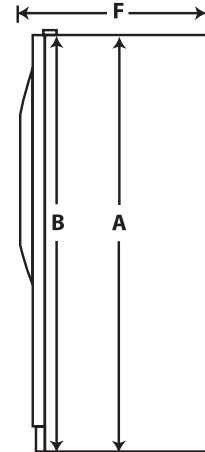

Allow sufficient clearance on hinge side of refrigerator when installing next to a wall where handle may make contact.

## TOP MOUNT REFRIGERATORS

21 Cu. Ft. Model	PHT219WH	PHT219H	GLHT217H	FRT156ES	FRT2156A
Series	Professional	Professional	Gallery	Frigidaire	Frigidaire
ENERGY STAR®					
<b>Capacities</b>					
Total Capacity (Cu. Ft.)	20.6	20.6	20.6	20.5	20.5
Fresh Food Volume (Cu. Ft.)	15.34	15.34	15.35	15.27	15.27
Freezer Volume (Cu. Ft.)	5.26	5.26	5.26	5.26	5.26
Total Shelf Area (Sq. Ft.)	25.0	25.0	24.4	24.5	24.5
<b>Exterior Conveniences</b>					
Door Handle	UltraPro Stainless Steel	UltraPro Stainless Steel	UltraSoft™	UltraSoft™	UltraSoft™
Water Through-The-Door Dispenser	•				
Reversible Door				•	•
<b>Interior Conveniences</b>					
Water Filter Location	Rear				
Water Filter Type	PureSource®				
Fresh Food Shelves	4 Half-Width Cant. SpillSafe™ Glass (3 Sliding)	4 Half-Width Cant. SpillSafe™ Glass (3 Sliding)	4 Half-Width Cant. SpillSafe™ Glass (1 Sliding)	2 Full-Width SpillSafe™ Glass (2 Sliding)	2 Full-Width SpillSafe™ Glass (2 Sliding)
Fresh Food Adjustable Bins	4 Clear	4 Clear	4 Clear		
Fresh Food Fixed Door Racks/Bins	1 White	1 White	1 White	3	3
No-Slip Liners	2	2	2		
Dairy Door	Clear	Clear	Clear	Clear	Clear
Meat/Deli Drawer	Clear	Clear	Clear	Clear	Clear
Crispers/Humidity Controls	Clear/2	Clear/2	Clear/2	Clear/2	Clear/2
Can Dispenser/Wine Rack	White	White			
Lighting	Mid Mount	Mid Mount	Mid Mount		
Freezer Fixed Door Racks/Bins	1 Clear	1 Clear	1 Clear	2 White	2 White
Freezer Tilt-Out Wire Door Bins	1	1	1		
Freezer Light	•	•	•		
Ice Trays					
Factory Ice Maker	•	•			
Condenser	Never Clean™	Never Clean™	Never Clean™	Never Clean™	Never Clean™
<b>Color / UPC (0-12505)</b>					
White (W)			67151-7		66118-1
Bisque (Q)			67152-4		66119-8
Black (B)			67153-1		66160-0
Stainless Steel/Black (B)				67017-6	
Stainless Steel/Black (S)			67154-8		
Stainless Steel/Silver Mist (SM)	67160-9	67158-6			
Left-Swing Door –					
Stainless Steel/Black (K)			67155-5	67018-3	
Stainless Steel/Silver Mist (KM)	67161-6	67159-3			
<b>Dimensions</b>					
A-Cabinet Height	68-1/4"	68-1/4"	68-1/4"	68-1/4"	68-1/4"
B-Total Height (w/Hinge Covers)	69"	69"	69"	69"	69"
C-Cabinet Width	29-5/8"	29-5/8"	29-5/8"	29-5/8"	29-5/8"
D-Cabinet Depth	28-1/2"	28-1/2"	28-1/2"	28-1/2"	28-1/2"
E-Depth (including Door)	31-3/4"	31-3/4"	31-3/4"	31-3/4"	31-3/4"
F-Total Depth (with Handles)	34-1/4"	34-1/4"	34"	34"	34"
G-Total Depth (Door 90° Open)	60"	60"	60"	60"	60"
Shipping Weight (Approx.)	220 Lbs.	220 Lbs.	220 Lbs.	220 Lbs.	220 Lbs.



White

Black

Bisque

Stainless Steel

Silver Mist

## TOP MOUNT REFRIGERATOR INSTALLATION

The following dimension and cutout information is for planning purposes only. For complete installation details consult manual packed with product, or download manual at [frigidaire.com](http://frigidaire.com).

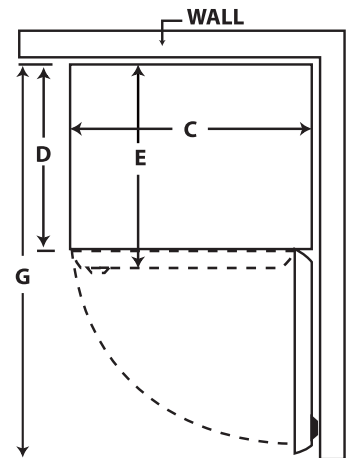
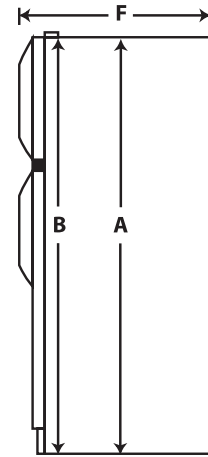

Allow sufficient clearance on hinge side of refrigerator when installing next to a wall where handle may make contact.

TOP MOUNT REFRIGERATORS

18 Cu. Ft. Model	PHT189WH	PHT189H	GLHT188WH	GLHT186H	FRT181S6C	FRT856E	FRT18S6A	FRT8G7H	FRT81B5H	FRT8B5H
Series	Professional	Professional	Gallery	Gallery	Frigidaire	Frigidaire	Frigidaire	Frigidaire	Frigidaire	Frigidaire
ENERGY STAR®										
<b>Capacities</b>										
Total Capacity (Cu. Ft.)	18.3	18.3	18.3	18.3	18.2	18.2	18.2	18.2	18.2	18.2
Fresh Food Volume (Cu. Ft.)	14.27	14.27	14.21	14.21	14.13	14.13	14.13	14.13	14.13	14.13
Freezer Volume (Cu. Ft.)	4.07	4.07	4.07	4.07	4.07	4.07	4.07	4.07	4.07	4.07
Total Shelf Area (Sq. Ft.)	22.4	22.4	22.4	22.4	22.6	22.6	22.6	22.3	19.5	19.5
<b>Exterior Conveniences</b>										
Door Handle	UltraPro Stainless Steel	UltraPro Stainless Steel	UltraSoft™	UltraSoft™	UltraSoft™	UltraSoft™	UltraSoft™	Straight	Straight	Straight
Water Through-The-Door Dispenser	.	.	.	.	.	.	.	.	.	.
Reversible Door				W/Q/B	.		.	.	.	W/Q/B
<b>Interior Conveniences</b>										
Water Filter Location	Rear		Rear							
Water Filter Type	PureSource®		PureSource®							
Fresh Food Shelves	4 Half-Width Cant. SpillSafe™ Glass (3 Sliding)	4 Half-Width Cant. SpillSafe™ Glass (3 Sliding)	4 Half-Width Cant. SpillSafe™ Glass (1 Sliding)	4 Half-Width Cant. SpillSafe™ Glass (1 Sliding)	2 Full-Width SpillSafe™ Glass (2 Sliding)	2 Full-Width SpillSafe™ Glass (2 Sliding)	2 Full-Width SpillSafe™ Glass (2 Sliding)	2 Sliding Glass	2 Sliding Wire	2 Sliding Wire
Fresh Food Adjustable Bins	4 Clear	4 Clear	4 Clear	4 Clear						
Fresh Food Fixed Door Racks/Bins	1 White	1 White	1 White	1 White	3 White	3 White	3 White	3 White	3 White	3 White
No-Slip Liners	2	2	2	2						
Dairy Door	Clear	Clear	Clear	Clear	Clear	Clear	Clear	Clear	Clear	Clear
Meat/Deli Drawer	Clear	Clear	Clear	Clear	Clear	Clear	Clear	Clear	Clear	Clear
Crispers/Humidity Controls	Clear/2	Clear/2	Clear/2	Clear/2	Clear/2	Clear/2	Clear/2	Clear/1	Clear/1	Clear/1
Can Dispenser/Wine Rack	White	White								
Lighting	Mid Mount	Mid Mount	Mid Mount	Mid Mount						
Freezer Fixed Door Racks/Bins	1 Clear	1 Clear	1 White	1 White	2 White	2 White	2 White	2 White	2 White	2 White
Freezer Tilt-Out Wire Door Bins	1	1	1	1						
Freezer Light	.	.	.	.						
Ice Trays										
Factory Ice Maker	.	.	.	.	.	.	.	.	.	.
Condenser	Never Clean™	Never Clean™	Never Clean™	Never Clean™	Never Clean™	Never Clean™	Never Clean™	Static	Static	Static
<b>Color / UPC (0-12505)</b>										
White (W)			67145-6	67140-1	73967-5		73390-1	67138-8	67136-4	67132-6
Bisque (Q)				67141-8	73968-2		73391-8	67139-5	67137-1	67133-3
Black (B)			67146-3	67142-5	66867-8		66213-3	67304-7		67134-0
Stainless Steel/Black (S)				67143-2		74428-0				
Stainless Steel/Silver Mist (SM)	67149-4	67147-0								
Silver Mist/Black (MB)						74475-4				
Left-Swing Door –										
Stainless Steel/Black (K)				67144-9		74429-7				
Stainless Steel/Silver Mist (KM)	67150-0	67148-7								
White (Z)										67135-7
<b>Dimensions</b>										
A- Cabinet Height	65-3/8"	65-3/8"	65-3/8"	65-3/8"	65-3/8"	65-3/8"	65-3/8"	65-3/8"	65-3/8"	65-3/8"
B- Total Height (w/Hinge Covers)	66-1/8"	66-1/8"	66-1/8"	66-1/8"	66-1/8"	66-1/8"	66-1/8"	66-1/8"	66-1/8"	66-1/8"
C- Cabinet Width	29-5/8"	29-5/8"	29-5/8"	29-5/8"	29-5/8"	29-5/8"	29-5/8"	29-5/8"	29-5/8"	29-5/8"
D- Cabinet Depth	26-5/8"	26-5/8"	26-5/8"	26-5/8"	26-5/8"	26-5/8"	26-5/8"	28-3/8"	28-3/8"	28-3/8"
E- Depth (including Door)	29-7/8"	29-7/8"	29-7/8"	29-7/8"	29-7/8"	29-7/8"	29-7/8"	31-5/8"	31-5/8"	31-5/8"
F- Total Depth (with Handles)	32-3/8"	32-3/8"	32-1/8"	32-1/8"	32-1/8"	32-1/8"	32-1/8"	33-5/8"	33-5/8"	33-5/8"
G- Total Depth (Door 90° Open)	58-1/8"	58-1/8"	58-1/8"	58-1/8"	58-1/8"	58-1/8"	58-1/8"	59-7/8"	59-7/8"	59-7/8"
Shipping Weight (Approx.)	205 Lbs.	205 Lbs.	205 Lbs.	205 Lbs.	205 Lbs.	205 Lbs.	205 Lbs.	205 Lbs.	205 Lbs.	205 Lbs.



## TOP MOUNT REFRIGERATORS

17 Cu. Ft. Model	FRT17G5CS	FRT17G4B	FRT17B3A
Series	Frigoaire	Frigoaire	Frigoaire
ENERGY STAR®			
<b>Capacities</b>			
Total Capacity (Cu. Ft.)	16.5	16.5	16.5
Fresh Food Volume (Cu. Ft.)	12.76	12.76	12.76
Freezer Volume (Cu. Ft.)	3.74	3.74	3.74
Total Shelf Area (Sq. Ft.)	20.6	21.0	18.2
<b>Exterior Conveniences</b>			
Door Handle	Straight	Straight	Straight
Reversible Door		.	W/Q
<b>Interior Conveniences</b>			
Fresh Food Shelves	2 Full-Width Sliding Glass	2 Full-Width Sliding Glass	2 Full-Width Sliding Wire
Fresh Food Door Rack/Bins	3 White	3 White	3 White
Dairy Door	Clear	Clear	White
Meat/Deli Drawer	Clear	Clear	
Crispers/Humidity Controls	Clear/2	Clear/2	White
Freezer Fixed Door Racks	2 White	2 White	2 White
Ice Trays	.		
Factory Ice Maker			
Condenser	Never Clean™	Static	Static
<b>Color/UPC (0-12505)</b>			
White (W)		73819-7	73388-8
Bisque (Q)		73820-3	73389-5
Stainless Steel/Black (B)	73909-5		
Left-Swing Door -			
Stainless Steel/Black (K)	73910-1		
White (Z)			73648-3
<b>Dimensions</b>			
A-Cabinet Height	64-3/8"	64-3/8"	64-3/8"
B-Total Height (w/Hinge Covers)	65-1/8"	65-1/8"	65-1/8"
C-Cabinet Width	28"	28"	28"
D-Cabinet Depth	26-5/8"	28-3/8"	28-3/8"
E-Depth (including Door)	29-3/8"	31-1/8"	31-1/8"
F-Total Depth (with Handles)	31-3/8"	33-1/8"	33-1/8"
G-Total Depth (Door 90° Open)	56"	57-3/4"	57-3/4"
Shipping Weight (Approx.)	190 Lbs.	190 Lbs.	190 Lbs.



White

Bisque

Stainless Steel

15 Cu. Ft. Model	FRT15G4B	FRT15B3A	FRT15A2D
Series	Frigoaire	Frigoaire	Frigoaire
<b>Capacities</b>			
Total Capacity (Cu. Ft.)	14.8	14.8	14.8
Fresh Food Volume (Cu. Ft.)	11.01	11.01	11.01
Freezer Volume (Cu. Ft.)	3.74	3.74	3.74
Total Shelf Area (Sq. Ft.)	20.3	17.8	16.9
<b>Exterior Conveniences</b>			
Door Handle	Straight	Straight	Recessed
Reversible Door	.	.	.
<b>Interior Conveniences</b>			
Fresh Food Shelves	2 Full-Width Sliding Glass	2 Full-Width Sliding Wire	2 Full-Width Sliding Wire
Fresh Food Door Racks	2-1/2 White	2-1/2 White	2-1/2 White
Dairy Door	Clear	White	White
Meat/Deli Drawer	Clear		
Crispers/Humidity Controls	Clear/2	White	Full-Width White
Freezer Fixed Door Racks	2 White	2 White	2 White
Condenser	Static	Static	Static
<b>Color/UPC (0-12505)</b>			
White (W)	73817-3	73383-3	74159-3
Bisque (Q)		73384-0	
Left-Swing Door -			
White (Z)			74247-7
<b>Dimensions</b>			
A-Cabinet Height	59-3/8"	59-3/8"	59-3/8"
B-Total Height (w/Hinge Covers)	60-1/8"	60-1/8"	60-1/8"
C-Cabinet Width	28"	28"	28"
D-Cabinet Depth	28-3/8"	28-3/8"	28-3/8"
E-Depth (including Door)	31-1/8"	31-1/8"	31-1/8"
F-Total Depth (with Handles)	33-1/8"	33-1/8"	31-1/8"
G-Total Depth (Door 90° Open)	57-3/4"	57-3/4"	57-3/4"
Shipping Weight (Approx.)	175 Lbs.	175 Lbs.	175 Lbs.



White

Bisque

## TOP MOUNT REFRIGERATOR INSTALLATION

The following dimension and cutout information is for planning purposes only. For complete installation details consult manual packed with product, or download manual at Customer Service, online at [frigidaire.com](http://frigidaire.com).

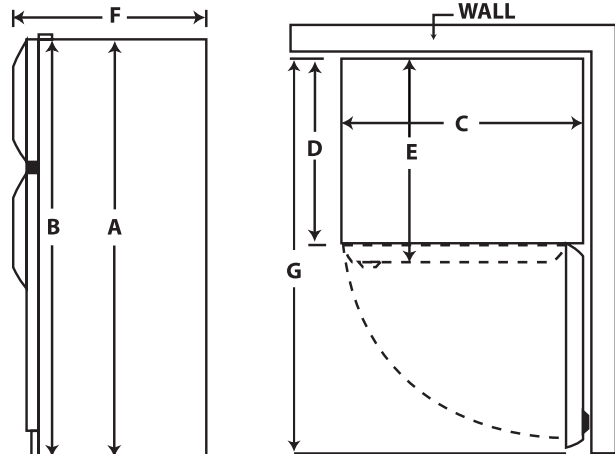

Allow sufficient clearance on hinge side of refrigerator when installing next to a wall where handle may make contact.

## ALL REFRIGERATORS

17 Cu. Ft. Model	FRU17G4J	FRU17B2J
Series	Frigoaire	Frigoaire
<b>Capacities</b>		
Total Capacity (Cu. Ft.)	16.7	16.7
Total Shelf Area (Sq. Ft.)	18.2	18.4
<b>Exterior Conveniences</b>		
Door Handle	Straight	Straight
<b>Interior Conveniences</b>		
Lighting	.	.
Shelves	3 Fixed Glass/ 1 Fixed Wire	2 Adjustable Wire/ 2 Fixed Wire
Door Bins	4 Full-Width/ 1 Tilt-Out Wire	5 Full-Width
Slide-Out Wire Baskets	2	
<b>Color/UPC (0-12505)</b>		
White (W)	21859-0	21851-4
<b>Dimensions</b>		
A-Height	64-1/2"	64-1/2"
B-Width	32"	32"
C-Depth (including Door)	26-1/2"	26-1/2"
D-Depth (with Door Open 90°)	57-1/8"	57-1/8"
Shipping Weight (Approx.)	214 Lbs.	214 Lbs.



White

## ALL-REFRIGERATOR INSTALLATION

The following dimension and cutout information is for planning purposes only. For complete installation details consult manual packed with product, or download manual at Customer Service, online at [frigidaire.com](http://frigidaire.com).

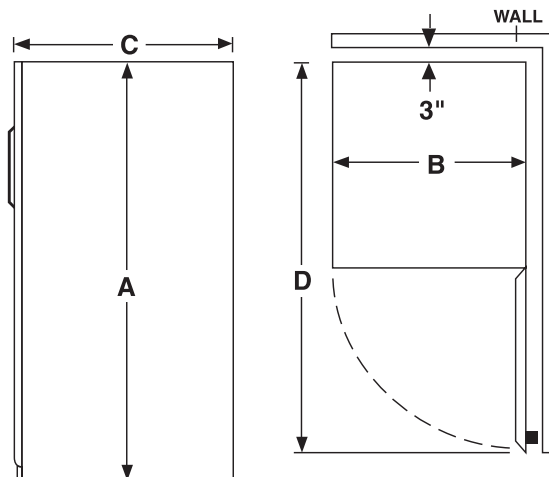

Allow sufficient clearance on hinge side of refrigerator when installing next to a wall where handle may make contact.

**ALL-FREEZER/ALL-REFRIGERATOR DUO**

34 Cu. Ft. Model	PLFU1778ES	PLRU1778ES
Series	Professional	Professional
<b>Capacities</b>		
Total Capacity (Cu. Ft.)	33.7	33.7
Total Shelf Area (Sq. Ft.)	34.8	34.8
Volume (Cu. Ft.)	16.8	16.9
Shelf Area (Sq. Ft.)	17.04	17.74
<b>Exterior Conveniences</b>		
Door Handle	UltraPro Stainless Steel	UltraPro Stainless Steel
<b>Interior Conveniences</b>		
Mid-Level Lighting (2 - 40W 4" Long Tubular per Unit)	.	.
Cantilever Shelves	2 FW	3 FW
Fixed Glass Shelves		1 FW
Sliding Glass Shelves	1 FW	
Door Bins	2 Tilt-Out Wire/ 3 FW Fixed White	4 Clear Adjustable/ 1 FW White Gallon
Dairy Door		1 Clear
Deli Drawer		1 Clear
Crispers/Humidity Controls		2 Clear/1
Full Access Sliding Baskets	2 FW	
<b>Color/UPC (0-12505)</b>		
Stainless Steel (S)	22355-6	22356-3
<b>Specifications</b>		
A - Height	64-1/2"	64-1/2"
B - Width (Single/Duo)	32"/64-1/4"	32"/64-1/4"
C - Depth (including Door)	26-1/2"	26-1/2"
D - Depth (with Door Open 90°)	57-1/4"	57-1/4"
Product Weight	207 Lbs.	205 Lbs.
Shipping Weight (Approx.)	229 Lbs.	227 Lbs.
<b>Optional Accessories</b>		
Duo Trim Kit	DUOTRIMKIT	DUOTRIMKIT
Single Unit Trim Kit	ALLFRZKIT	ALLREFKIT
Ice Maker	IM501	



Stainless Steel

**BEVERAGE CENTERS**

Model	PLKU1267DS	FRTB7B4E
Series	Professional	Frigidaire
<b>Capacities</b>		
Total Capacity (Cu. Ft.)	11.7	16.5
Fresh Food Volume (Cu. Ft.)		12.75
Freezer Volume (Cu. Ft.)		3.75
Total Shelf Area (Sq. Ft.)		17.1
<b>Exterior Conveniences</b>		
Door Surface	Stainless Steel	Silver Mist
Door Swing	Standard	Reversible
Door Handle(s)	Recessed	Recessed
Dispensing Kit	.	.
Drip Tray	.	.
<b>Interior Conveniences</b>		
Auxiliary/Fresh Food Shelves	2 Fixed Wire	1 Adjustable Wire
Full-Access Baskets		2 Sliding Wire
Door Racks	2	
Can Dispenser/Wine Rack		5-Level Wire
Keg Capacity	16 Gallon	16 Gallon
CO <sub>2</sub> Tank	.	.
<b>Freezer Conveniences</b>		
Door Racks		2
Shelves		1 Full-Width Wire
<b>Color/UPC (0-12505)</b>		
Stainless Steel (S)	22326-6	
Silver Mist/Black (MB)		74503-4
<b>Dimensions</b>		
A - Cabinet Height	54-1/2"	64"
B - Cabinet Width	28"	28-3/8"
C - Cabinet Depth	24-1/4"	26-5/8"
D - Cabinet Depth (with Door)	26-1/2"	29-3/8"
E - Cabinet Depth (with Drip Tray)	32-1/2"	35-3/8"
F - Total Depth (with Door 90° Open)	53-1/8"	58"
Cabinet Height (with Hinge Cover)	55-1/8"	64-7/8"
Cabinet Height (with Optional Casters)	59-1/4"	68-1/2"
Shipping Weight (Approx.)	175 Lbs.	188 Lbs.
<b>Optional Accessories</b>		
Caster Kit	297027300	5304451343
Fresh Food Wire Shelf		241667701
Ice Maker		IM115
Drip Tray Hose Kit		5304451963
Cleaning Kit		5304443671

Additional accessories and replacement parts are available at [frigidaire.com](http://frigidaire.com) or [www.micromatic.com/frigidaire](http://www.micromatic.com/frigidaire)



Stainless Steel

Silver Mist

**ALL-FREEZER/ALL-REFRIGERATOR DUO INSTALLATION**

The following dimension and cutout information is for planning purposes only. For complete installation details consult manual packed with product, or download manual at Customer Service, online at [frigidaire.com](http://frigidaire.com).

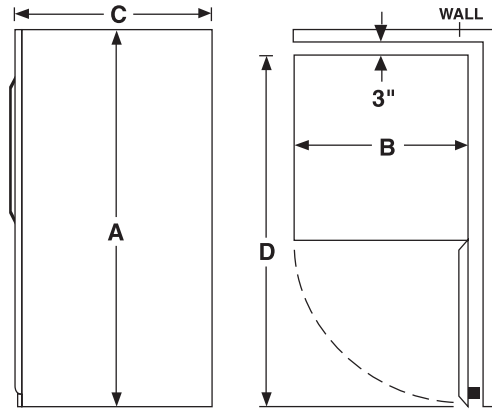

Allow sufficient clearance on hinge side of unit when installing next to a wall where handle may make contact.

**CUTOUT DIMENSIONS**

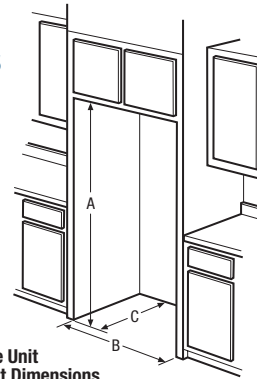

**Single Unit Cutout Dimensions**

- Without Trim Kit (A) 66" (B) 33" (C) 25 1/4" min.
- With Trim Kit (A) 75" (B) 33" (C) 25 1/4" min.

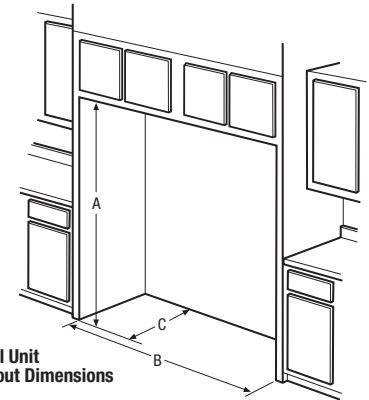

**Dual Unit Cutout Dimensions**

- Without Trim Kit (A) 66" (B) 66" (C) 25 1/4" min.
- With Trim Kit (A) 75" (B) 66" (C) 25 1/4" min.

**BEVERAGE CENTER INSTALLATION**

The following dimension and cutout information is for planning purposes only. For complete installation details consult manual packed with product, or download manual at Customer Service, online at [frigidaire.com](http://frigidaire.com).

Models PLKU1267DS & FRTB7B4E

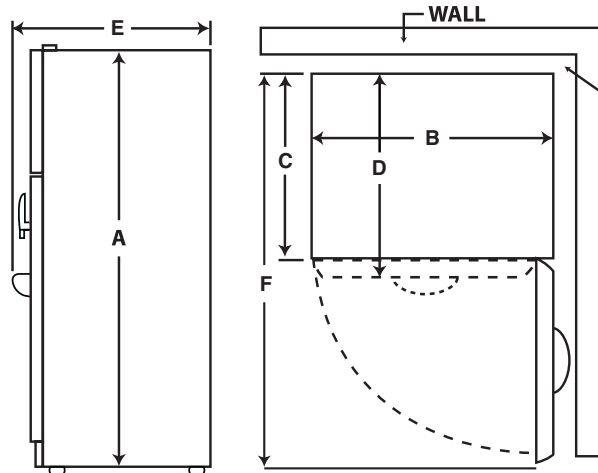

**Important Clearance Information:** Beverage Center model PLKU1267DS is not designed for built-in application and requires a minimum clearance of 3" around the top, back and sides of the cabinet to allow for adequate ventilation and ensure proper cooling.

If beverage center is installed too close to wall, door will not open full 90° due to drip tray.

# Frigidaire

## LIMITED ONE-YEAR WARRANTY

This warranty does not cover the following:

- Products with original serial numbers that have been removed, altered or cannot be readily determined.
- Product that has been transferred from its original owner to another party or removed outside the USA or Canada.
- Rust on the interior or exterior of the unit.
- Products purchased "as-is" are not covered by this warranty.
- Food loss due to any refrigerator or freezer failures.
- Products used in a commercial setting.
- Service calls which do not involve malfunction or defects in materials or workmanship, or for appliances not in ordinary household use or used other than in accordance with the provided instructions.
- Service calls to correct the installation of your appliance or to instruct you how to use your appliance.
- Expenses for making the appliance accessible for servicing, such as removal of trim, cupboards, shelves, etc., which are not a part of the appliance when it is shipped from the factory.
- Service calls to repair or replace appliance light bulbs, air filters, water filters, other consumables, or knobs, handles, or other cosmetic parts.
- Surcharges including, but not limited to, any after hour, weekend, or holiday service calls, tolls, ferry trip charges, or mileage expense for service calls to remote areas, including the state of Alaska.
- Damages to the finish of appliance or home incurred during installation, including but not limited to floors, cabinets, walls, etc.
- Damages caused by: services performed by unauthorized service companies; use of parts other than genuine Electrolux parts or parts obtained from persons other than authorized service companies; or external causes such as abuse, misuse, inadequate power supply, accidents, fires, or acts of God.

## DISCLAIMER OF IMPLIED WARRANTIES; LIMITATION OF REMEDIES

Customer's sole and exclusive remedy under this limited warranty shall be product repair or replacement as provided herein. Claims based on implied warranties, including warranties of merchantability or fitness for a particular purpose, are limited to one year or the shortest period allowed by law, but not less than one year. Electrolux shall not be liable for consequential or incidental damages such as property damage and incidental expenses resulting from any breach of this written limited warranty or any implied warranty. Some states and provinces do not allow the exclusion or limitation of incidental or consequential damages, or limitations on the duration of implied warranties, so these limitations or exclusions may not apply to you. This written warranty gives you specific legal rights. You may also have other rights that vary from state to state.

## IF YOU NEED SERVICE

Keep your receipt, delivery slip, or some other appropriate payment record to establish the warranty period should service be required. If service is performed, it is in your best interest to obtain and keep all receipts. Service under this warranty must be obtained by contacting Electrolux at the addresses or phone numbers below. Your appliance is covered by a one year limited warranty. For one year from your original date of purchase, Electrolux will pay all costs for repairing or replacing any parts of this appliance that prove to be defective in materials or workmanship when such appliance is installed, used, and maintained in accordance with the provided instructions. This warranty only applies in the USA and Canada. In the USA, your appliance is warranted by Electrolux Major Appliances North America, a division of Electrolux Home Products, Inc. In Canada, your appliance is warranted by Electrolux Canada Corp. Electrolux authorizes no person to change or add to any obligations under this warranty. Obligations for service and parts under this warranty must be performed by Electrolux or an authorized service company. Product features or specifications as described or illustrated are subject to change without notice.

## USA

### Electrolux Major Appliances, North America

250 Bobby Jones Expressway  
Martinez, GA 30907  
1-800-FRIGIDAIRE  
[frigidaire.com](http://frigidaire.com)

## CANADA

### Electrolux Canada Corporation

5855 Terry Fox Way  
Mississauga, ON L5V 3E4  
1-800-668-4606



Every Frigidaire® appliance is backed by the global strength of the Electrolux Group, the world's largest manufacturer of kitchen and cleaning appliances.