

Built-In Microwave

EI30MO45G S



Microwave shown with Stainless Steel Faceplate



Automatic Cooking Functions:

Features 11 Auto Cook options, 3 Auto Reheat options and 6 Auto Defrost options for amazing cooking flexibility. The 30-minute Keep Warm function maintains dishes at optimal serving temperatures.



Premium Sensor Cooking

Ten Sensor Touch options available to determine exact cooking time of many commonly prepared dishes. Sensors eliminate guesswork by automatically calculating remaining cooking time.



Stage Cooking Options

Four cooking options ensure any dish requiring multiple cooking stages is optimally prepared. Easily defrost and cook with simple commands.



16" Glass Turntable

Effectively distributes heat evenly to ensure food cooks thoroughly and precisely. Eliminates cold spots for perfect results every time.

30" BUILT-IN SIDE-SWING DOOR MICROWAVE

Oven Cavity	2.0 Cu. Ft.
Watts	1100
Oven Interior	White
Interior Krypton Light	Yes
16" Glass Turntable	Yes

Control Panel Features

IQ-Touch™ Electronic Controls	Yes
Front Display with Blue LED	Yes
Electronic Clock & Timer	Yes
Humidity Sensor	Yes
Power Levels	11
Touch Pad Controls	33
Auto Start	Yes
Auto Defrost Options	6
Auto Cook Options – Pizza (1), Snacks (3), Kid's Meals (3), Soften/Melt (4)	11
Auto Reheat Options – Breads/Muffins (2), Pasta/Casserole (1)	3
Beverage (0.5-2.0 Cups)	Yes
Sensor Touch Options – Cook (5), Reheat, Popcorn, Baked Potato, Frozen Vegetables, Fresh Vegetables	10
Stage Cooking Options	4
Shortcut Options	6
Add 30 Seconds	Yes
Keep Warm	Yes
Custom Help Options	Yes
Panel Lock	Yes
Demo Mode	Yes
Adjustable Sound Level For Timers/Reminders	Yes
More/Less Function	Yes
Power Failure Indicator	Yes

Additional Features

Signature Soft-Arc Oven Door	Yes
Glass Window	Yes

Specifications

Oven Cavity Dimensions –	
Height	10-1/2"
Width	17-3/8"
Depth	18-5/8"
Overall Exterior Dimensions –	
Height	18-1/16"
Width	30"
Depth (to Center of Arc)	19-1/8"
Approved for Under-Counter Installation	Yes
Approved for Electric Single Oven Combination Installation*	Yes
Power Supply Connection Location	Right Top Rear
Voltage Rating	120V/60Hz/15 or 20A
Connected Load (kW Rating) @ 120 Volts†	1.5
Amps @ 120V	13
60" Electrical Cable	Included
Microwave – Watts @ 120 Volt input	1500
Frequency (Mhz)	2450
Product Weight (Approx.) – Microwave with 30" Trim Kit	48 Lbs.
Shipping Weight (Approx.) – Microwave	46 Lbs.
Shipping Weight (Approx.) – 30" Trim Kit	10 Lbs.

† For use on adequately wired 120V, dedicated circuit having 2-wire service with a separate ground wire. Appliance must be grounded for safe operation.

* Approved to be used in combination with any Electrolux Electric Single Wall Oven and/or Warmer Drawer. (Not approved to be used above any gas wall oven.)

** 30" Trim Kit (EI30MO45TK) is supplied and includes Stainless Steel Faceplate and Bottom Duct Assembly – shipped in separate box.

NOTE: Always consult local and/or national electric codes. Refer to Product Installation Guide for detailed installation instructions on the web at www.electroluxappliances.com.

Specifications subject to change.

***Note:** When used in combination with another Electrolux built-in product, a minimum clearance of 2⁷/₈" required from bottom of Built-In Microwave cutout to top edge of companion product's faceplate, leaving a 2" visible gap between both product faceplates

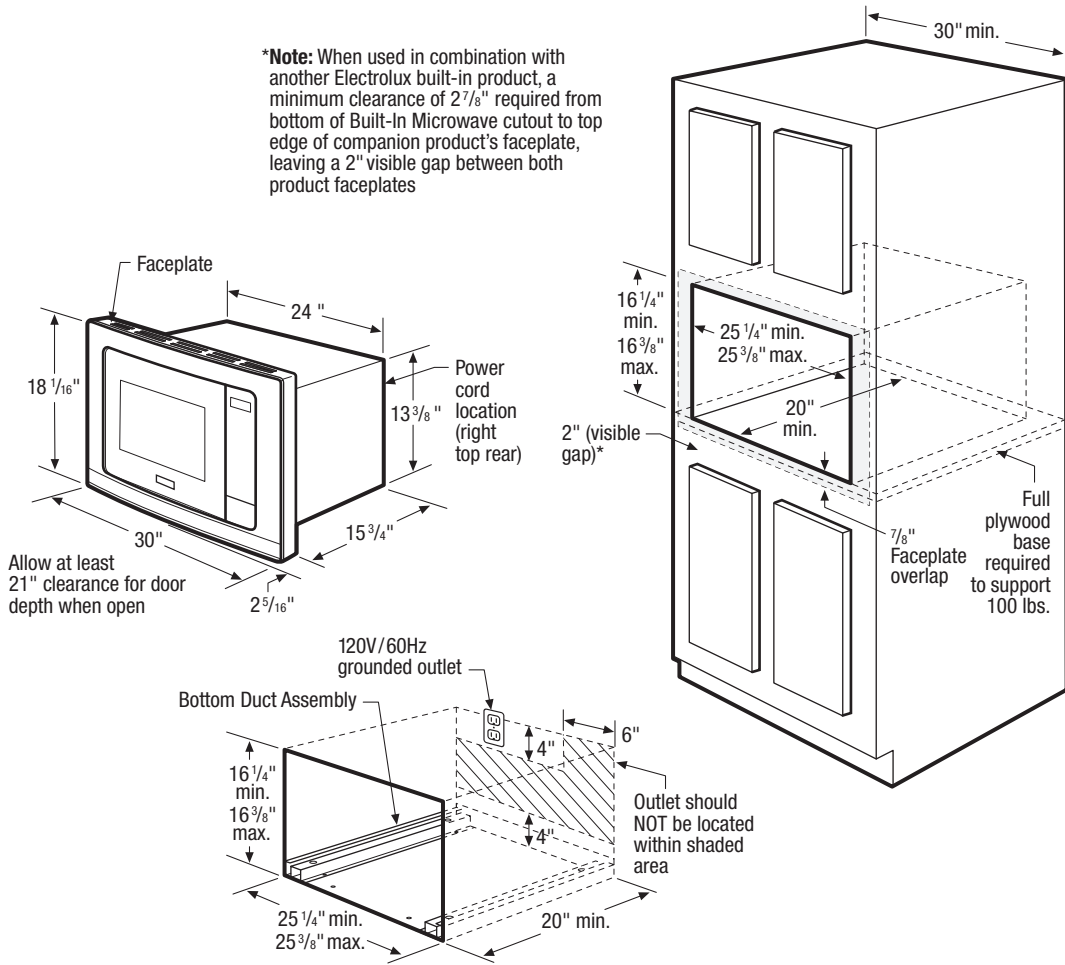

30" Built-In Microwave Specifications

- Microwave Product Weight – 48 Lbs.
- Voltage Rating – 120V/60Hz/ 15 or 20 Amps
- Connected Load (kW Rating) @ 120 Volts = 1.5kW (For use on adequately wired 120V, dedicated circuit having 2-wire service with a separate ground wire. Appliance must be grounded for safe operation.)
- Amps @ 120 Volts = 13 Amps
- Always consult local and/or national electric codes.
- Allow 21" minimum clearance for 90° door swing.
- Built-in installation requires use of 30" Trim Kit (EI30MO45TK) which is supplied and includes Stainless Steel Faceplate and Bottom Duct Assembly – shipped in separate box.
- Minimum 20" deep oven cutout dimension is critical for proper installation for oven and faceplate to fit flush against cabinet front.
- Consult local building code, in the event that cutout opening may be required to be enclosed with sides, ceiling and rear partition.

- Full base of solid plywood or similar material required, capable of supporting 100 Lbs.
- Base must be level and front of cabinet square for proper operation.
- Grounded outlet should NOT be located in shaded area, as indicated.
- Can NOT be installed above any gas wall oven.
- Built-In Convection Microwave can be built in alone or is approved to be used in combination with any Electrolux Electric Single Wall Oven and/or Warmer Drawer.
- When used in combination with another Electrolux built-in product, a minimum clearance of 2-7/8" required from bottom of Built-In Microwave cutout to top edge of companion product's faceplate, leaving a 2" visible gap between both product faceplates.

Note: For planning purposes only. Refer to Product Installation Guide on the web at electroluxusa.com for detailed instructions.