

PROTECTIVE BARRIERS

PROTECTIVE BARRIERS FOR PEOPLE AND PROPERTY

APPLICATIONS

- ◆ Inner Plant Offices
- ◆ Shipping & Receiving Areas
- ◆ Aisle Ways
- ◆ Personnel Protection
- ◆ Parking Lots
- ◆ Racks & Shelves
- ◆ Specialty Machinery
- ◆ Mezzanines
- ◆ Recreation Areas

GUARD RAIL SYSTEMS

PAGE 2 & 3

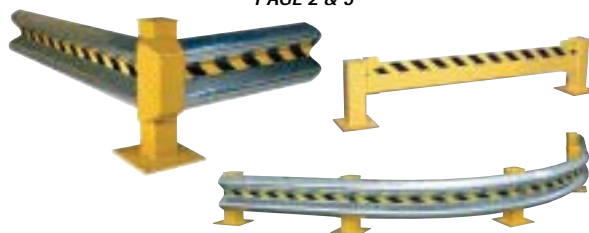

SAFETY BOLLARDS

PAGE 4 & 5



MACHINERY & RACK GUARDS

PAGE 6 & 7

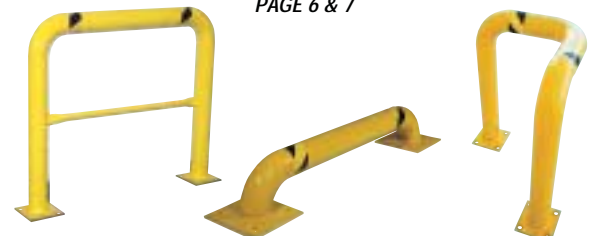

COLUMN & PIPE PROTECTORS

PAGE 8 & 9



RACK GUARDS

PAGE 10 & 11

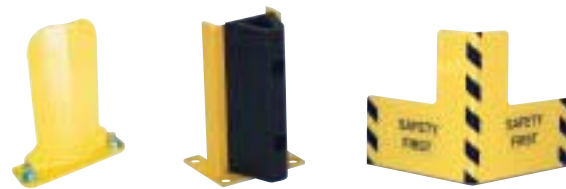

SAFETY RAILING

PAGE 12 & 13

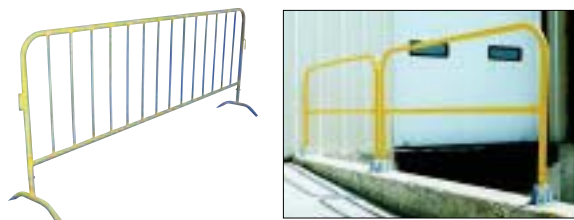

GUIDANCE BARRIERS / GATES / MISC.

PAGE 14 to 16

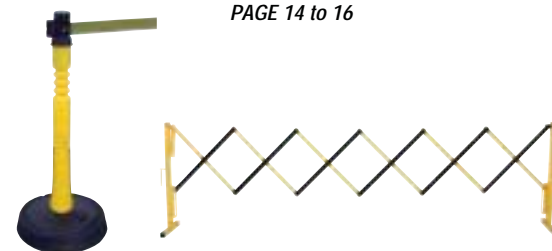

Beacon Industries, Inc.
 12300 Old Tesson Rd.
 St. Louis, MO 63128-2247 USA
 Phone: (314) 487-7600 Fax: (314) 487-0100
www.beacontechnology.com
 E-Mail: sales@beacontechnology.com

GUARD RAIL SYSTEMS

Protect personnel and equipment both visually and physically with our Guard Rail Systems. Choose our galvanized guard rail or our structural c-channel guard rail, both offer maximum durability and protection. These economical systems can be utilized indoors or outdoors. Choose between one, two, or three rail high systems. Tubular posts are machined for continuous or perpendicular rail mounting. US D.O.T. guardrail mounting and I-beam posts available, contact factory. Post mounting hardware included. Floor mounting kit sold separately.

APPLICATIONS

- ◆ Offices
- ◆ Specialty Machinery
- ◆ Recreation Areas
- ◆ Personnel Protection
- ◆ Parking Lots
- ◆ Shipping and Receiving Areas

GALVANIZED GUARD RAIL SYSTEMS

GALVANIZED RAIL
for mar and corrosion resistance

PLASTIC END CAP
7"W x 13-1/2"H x 4"D

BLACK & YELLOW CAUTION TAPE
standard on all rails

YELLOW POWDER COAT FINISH
standard on all rigid posts (BGR-TP18 post pictured)

10 GAUGE RAILS
12"H x 3-3/8"D

RIGID POSTS
5" x 5" with 3/16" wall

DOUBLE RAIL
Mount two rails onto a single post to protect a higher/larger area (BGR-TP42 posts pictured)

FLOOR MOUNTING KIT
for Rigid Posts • Model BGR-ABK
Sold Separately

OVERLAPPING RAILS
Deduct 5" from length when overlapping rails

SPRING POST
Model BGR-SP
Post flexes when hit

DRAWING

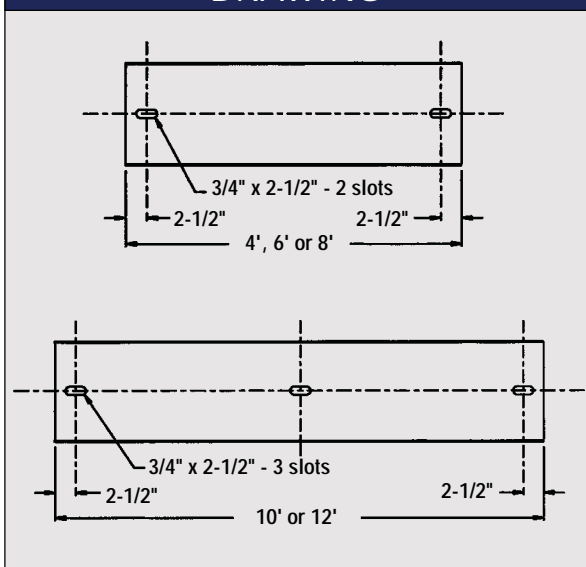

MODEL	DESCRIPTION
BGR-4	Galvanized Rail - 4 ft. Long
BGR-6	Galvanized Rail - 6 ft. Long
BGR-8	Galvanized Rail - 8 ft. Long
BGR-10	Galvanized Rail - 10 ft. Long
BGR-12	Galvanized Rail - 12 ft. Long
BGR-4-PC-YEL	Powder Coated Rail - 4 ft. Long
BGR-6-PC-YEL	Powder Coated Rail - 6 ft. Long
BGR-8-PC-YEL	Powder Coated Rail - 8 ft. Long
BGR-10-PC-YEL	Powder Coated Rail - 10 ft. Long
BGR-12-PC-YEL	Powder Coated Rail - 12 ft. Long
BGR-TP18	Tubular Post 18" High (Accommodates 1 Rail)
BGR-TP42	Tubular Post 42" High (Accommodates 2 Rails)
BGR-TP60	Tubular Post 60" High (Accommodates 3 Rails)
BGR-TP72	Tubular Post 72" High (Accommodates 3 Rails)
BGR-SP	Spring Post 24" High
BGR-SPP	Spring Post Mounting Plate (for asphalt)
BGR-CAP	Plastic Yellow End Cap & Corner Guard
BGR-ABK	Mounting Kit (4) 3/4" x 4" Anchor Bolts

90° CURVED GALVANIZED GUARD RAILS

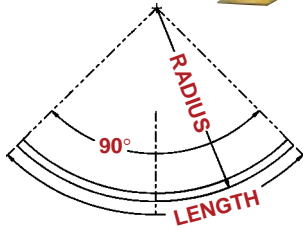
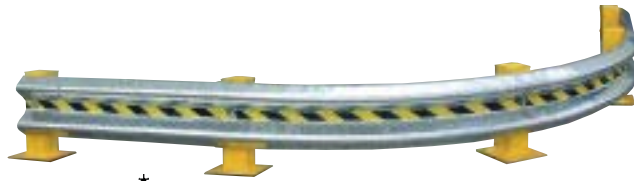

Protect the corners of buildings and walls from damage from fork trucks and vehicles. Also works good at corners of driveways to direct traffic. Features a 90° angle and works with our BGR series straight rails. Use with tubular (BGR-TP) or spring (BGR-SP) posts.

MODEL	POSTS REQUIRED	LENGTH	HEIGHT	RADIUS
BGR-4-CRV	2	48"	12"	30-1/2"
BGR-6-CRV	2	72"	12"	46"
BGR-8-CRV	3	96"	12"	61"
BGR-10-CRV	3	120"	12"	75-1/2"
BGR-12-CRV	3	144"	12"	91-1/2"

SERIES BGR-CRV

SPECIALTY END GUARDS



Model BGR-BG
Adds 28" to Length

BUFFER



Model BGR-TG
Adds 18" to Length

FLARED



Model BGR-CAP
Adds 3" to Length

PLASTIC

Heavy duty end guards protect personnel, buildings, walls and pallet racking against damage from fork trucks and vehicle traffic. Attaches easily to the ends or corner connection of guard rail.

MODEL	STYLE	OVERALL SIZE
BGR-BG	Buffer	48"L x 16"H x 12-1/2"D
BGR-TG	Flared	27"L x 18"H x 10"D
BGR-CAP	Plastic	7"W x 13-1/2"H x 4"D

SERIES BGR

STRUCTURAL GUARD RAIL - Drop In Style

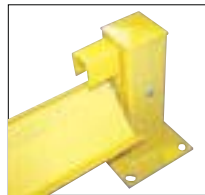
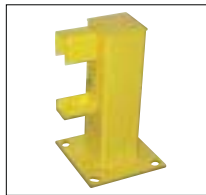

Constructed of structural C-channel 8.2 lbs. per foot for maximum strength and protection. Drop in style design protects personnel and machinery. Railing can be removed in a matter of seconds. Available in custom lengths.

MODEL	DESCRIPTION	HEIGHT	LENGTH
BSTGR-4	Guard Rail	6"	48"
BSTGR-6	Guard Rail	6"	72"
BSTGR-8	Guard Rail	6"	96"
BSTGR-10	Guard Rail	6"	120"
BSTGR-12	Guard Rail	6"	144"
BSTGR-TP-18DI	Tubular Post	18"	
BSTGR-TP-42DI	Tubular Post	42"	
BSTGR-TP-60DI	Tubular Post	60"	
BSTGR-TP-72DI	Tubular Post	72"	

SERIES BSTGR

DROP IN STYLE GUARD RAIL



Shown with
Galvanized Guard Rail

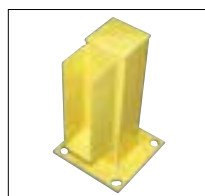
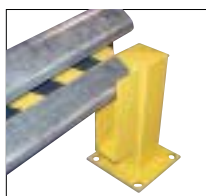

Protect personnel and equipment with "Drop in Style" Guard Rail Systems. Easy to install railing provides protection of machinery and personnel while still providing quick access to repair or replace machinery. Each post has a bolt on bracket that allows you to slide the railing in and out. Works with our galvanized or powder coated GR-series railing.

MODEL	DESCRIPTION	HEIGHT
BGR-TP18-DI	Tubular Post with Bracket	18"
BGR-TP42-DI	Tubular Post with Bracket	42"
BGR-TP60-DI	Tubular Post with Bracket	60"
BGR-TP72-DI	Tubular Post with Bracket	72"

SERIES BGR-TP

SAFETY BOLLARDS

APPLICATIONS

- ◆ Offices
- ◆ Specialty Machinery
- ◆ Aisle Ways
- ◆ Rack & Shelving
- ◆ Parking Lots
- ◆ Shipping and Receiving Areas
- ◆ Mezzanines

MOUNTING PLATES

- ◆ 1-3/4" guards have 5" x 5" plate
- ◆ 4" guards have 8" diameter plates
- ◆ 4-1/2" guards have 10" x 10" plates
- ◆ 5-1/2" guards have 12" x 12" plates

* NOTE: All mounting plates are 3/8" thick and have 1" diameter holes located 1" on center from all edges

* Excluding Chrome and 1-3/4" Diameter Bollards

MOUNTING KITS



OPTIONAL ANCHOR BOLTS
Suffix -BABK

STEEL SAFETY BOLLARDS

SERIES BBOL



Bollards can be used both indoors and outdoors to protect work areas, racking and personnel. Powder coated safety yellow finish. Molded rubber caps are removable standard on 4-1/2" and 5-1/2" diameter units. Caps are welded on the 1-3/4" diameter units. Mounting kits and replacement caps available.



Removable Rubber Caps are standard on 4-1/2" and 5-1/2" diameter units



MODEL	HEIGHT	DIAMETER	CAPS
BBOL-24-2	24"	1-3/4"	Welded
BBOL-36-2	36"	1-3/4"	Welded
BBOL-42-2	42"	1-3/4"	Welded
BBOL-24-4.5	24"	4-1/2"	Removable
BBOL-36-4.5	36"	4-1/2"	Removable
BBOL-42-4.5	42"	4-1/2"	Removable
BBOL-24-5.5	24"	5-1/2"	Removable
BBOL-36-5.5	36"	5-1/2"	Removable
BBOL-42-5.5	42"	5-1/2"	Removable
BBOL-ABK-3	Mounting Kit (4) 3/8" x 3" Anchor Bolts		
BBOL-ABK-4	Mounting Kit (4) 3/4" x 4" Anchor Bolts		

STEEL CHROME BOLLARD

SERIES BCBOL



Improve the image of your facility while protecting people and equipment with this heavy-duty Chrome Bollard. Unit is made of steel and finished with an attractive bright chrome plating for a clean fresh look. A black plastic top cap is removable to fill the bollard with concrete for greater strength and stability. The mounting plate is predrilled with (4) 1/2" diameter holes for quick and easy installation. Base diameter is 8". Mounting kit available.



8" Diameter Base with (4) 1/2" Holes

MODEL	DESCRIPTION	SIZE
BCBOL-42-4	Steel Chrome Bollard	42"H x 4"D
BCBOL-ABK-3	Mounting Kit	(4) 3/8" x 3"

PROTECTIVE DOME COVERS & PLASTIC CAPS FOR BOLLARDS

SERIES BDOME



- Looks Better & Cleans Easier
- Prevents Tripping Hazards
- One Stop Quick Installation
- No more Punctured Pneumatic Tires
- No Hardware Required



Series BDOME



Model BBC-B-1.5

Prevent accidents and injuries. Easy to use device slides over and down bollards covering hardware. Outside diameter is 14". Overall height is 3". Powder coat finish. Plastic Hardware Caps snap over the top of anchor hardware. Sold separately.

MODEL	DESCRIPTION
BDOME-4.5	Dome Cover - Fits 4-1/2" Dia. Bollards
BDOME-5.5	Dome Cover - Fits 5-1/2" Dia. Bollards
BBC-B-1.5	(4) Caps to Snap Over the Top of Anchor Bolts

BOLLARD CAPS



CAST STEEL



MOLDED RUBBER

Replace lost or damaged bollard caps. Available in Cast Steel or Molded Rubber. Easy to attach. Steel caps must be welded in place. Rubber cap installation is press-fit.

MODEL	MATERIAL	FITS A PIPE INNER DIAMETER	FITS MODEL
BOL-CAP-4.5-S	Cast Steel	4.26" (4" SCH. 10 Pipe)	BOL-4.5
BOL-CAP-5.5-S	Cast Steel	5.30" (5" SCH. 10 Pipe)	BOL-5.5
BOL-CAP-4.5-R	Molded Rubber	4.26" (4" SCH. 10 Pipe)	BOL-4.5
BOL-CAP-5.5-R	Molded Rubber	5.30" (5" SCH. 10 Pipe)	BOL-5.5

PLASTIC BOLLARD COVERS



Eliminate the need for costly scraping and painting of unsightly bollards. The low density polyethylene thermoplastic molded sleeves slide over existing bollards. No hardware needed. Additional sizes and colors available.

MODEL	HEIGHT	DIAMETER	USE WITH
BPC-24-4.5	24"	4-3/4" I.D	BOL-24-4.5
BPC-24-4.5	36"	4-3/4" I.D	BOL-36-4.5
BPC-42-4.5	42"	4-3/4" I.D	BOL-42-4.5
BPC-24-5.5	24"	5-3/4" I.D	BOL-24-5.5
BPC-24-5.5	36"	5-3/4" I.D	BOL-36-5.5
BPC-42-5.5	42"	5-3/4" I.D	BOL-42-5.5

RIBBED PLASTIC BOLLARD COVER



Custom Screen Print Available

Attractive bollard sleeve is made of plastic and includes vertical ribs for an aesthetically pleasing appearance. Each sleeve includes a top cap. Two opposite sides include a flat area 2" wide to display a vertical sign if desired. Safety yellow in color. Includes installation hardware. Custom screen print, special colors and sizes are available.

MODEL	USE WITH PIPE DIAMETER	HEIGHT
BSLEE-24	4", 5", 6"	24"
BSLEE-42	4", 5", 6"	42"
BSLEE-54	4", 5", 6"	54"

SPRING LOADED BOLLARDS



Strobe Light & Beeper

The yellow powder coated bollard with spring loaded design alerts personnel that they are too close to the fixture being protected. A mercury switch activated warning beeper and strobe light is optional. This feature alerts the individual that they have hit the bollard and should stop. Units are 2-1/2" in diameter and stand 42" tall.

MODEL	DESCRIPTION
BSPBOL-42	Steel Pipe Bollard
BSPBOL-42-B	Steel Pipe Bollard with Beeper
BSPBOL-42-BL	Steel Pipe Bollard w/Beeper & Strobe
BSLBOL-ABK	Mounting Kit (4) 3/8" x 3" Anchor Bolts

MACHINERY & RACK GUARDS

Protect people and machinery both visually and physically with our Machinery and Rack Guards. Constructed of heavy duty, all welded steel pipe and powder coated safety yellow for high visibility and scratch resistance.

- ◆ Offices
- ◆ Aisle Ways
- ◆ Parking Lots
- ◆ Mezzanines

MOUNTING PLATES

- ◆ 1-3/4" guards have 5" x 5" plate
- ◆ 4" guards have 8" x 8" plates

* NOTE: All mounting plates are 3/8" thick and have 1" diameter holes located 1" on center from all edges

* Excluding 1-3/4" Diameter Guards

HIGH PROFILE MACHINERY GUARDS

SERIES BHPRO



Ideal for inplant use to protect expensive equipment. A bar runs horizontally half way up on 42" high units. Safety yellow durable powder coat finish standard.

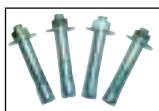

Mounting Kit
Model BHPRO-ABK

MODEL	HEIGHT	LENGTH	DIAMETER (O.D.)
BHPRO-36-24-2	24"	36"	1-3/4"
BHPRO-48-24-2	24"	48"	1-3/4"
BHPRO-36-36-2	36"	36"	1-3/4"
BHPRO-48-36-2	36"	48"	1-3/4"
BHPRO-36-42-2	42"	36"	1-3/4"
BHPRO-48-42-2	42"	48"	1-3/4"
BHPRO-36-24-4	24"	36"	4"
BHPRO-48-24-4	24"	48"	4"
BHPRO-36-36-4	36"	36"	4"
BHPRO-48-36-4	36"	48"	4"
BHPRO-36-42-4	42"	36"	4"
BHPRO-48-42-4	42"	48"	4"
BHPRO-ABK-3	Mounting Kit (8) 3/8" x 3" Anchor Bolts		
BHPRO-ABK-4	Mounting Kit (8) 3/4" x 4" Anchor Bolts		

LOW PROFILE RACK GUARDS

SERIES BLPRO

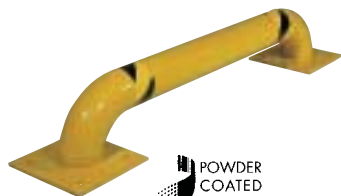

Use indoors to protect valuable pallet racking, machinery and personnel. High visibility yellow powder coat finish.



Mounting Kit
Model BLPRO-ABK

MODEL	HEIGHT	LENGTH	DIAMETER (O.D.)
BLPRO-36-9-2	9"	36"	1-3/4"
BLPRO-48-9-2	9"	48"	1-3/4"
BLPRO-36-16-2	16"	36"	1-3/4"
BLPRO-48-16-2	16"	48"	1-3/4"
BLPRO-36-9-4	9"	36"	4"
BLPRO-48-9-4	9"	48"	4"
BLPRO-36-16-4	16"	36"	4"
BLPRO-48-16-4	16"	48"	4"
BLPRO-ABK-3	Mounting Kit (8) 3/8" x 3" Anchor Bolts		
BLPRO-ABK-4	Mounting Kit (8) 3/4" x 4" Anchor Bolts		

TRIPLE ELBOW GUARDS

SERIES BTEG



Protect the corners of machinery, buildings and offices. The 90° bend fits snug around corners to provide the ultimate protection against lift trucks or other mobile equipment.



Mounting Kit
Model BTEG-ABK

MODEL	HEIGHT	LENGTH	DIAMETER (O.D.)
BTEG-24-24-4	24"	24"	4"
BTEG-24-36-4	36"	24"	4"
BTEG-24-42-4	42"	24"	4"
BTEG-30-24-4	24"	30"	4"
BTEG-30-36-4	36"	30"	4"
BTEG-30-42-4	42"	30"	4"
BTEG-ABK	Mounting Kit (8) 3/4" x 4" Anchor Bolts		

ADJUSTABLE RACK GUARD



Protect the row ends of tandem pallet racking with this heavy duty, welded steel adjustable rack guard. Slide in design has a variable width range of 78" to 108". Includes steel mounting plates with 1" dia. holes to safely secure unit to floor. Powder coat safety yellow finish.

MODEL	DESCRIPTION	LENGTH	HEIGHT
BARMG-24	Structural Steel	78" to 108"	24"
BARMG-ABK	Mounting Kit (12) 3/4" x 4" Anchor Bolts		

CONCRETE ANCHORING HARDWARE



(4) Anchors and
(1) Masonry Bit Shown

Install Rack, Column and Machinery Guards quickly and easily with Concrete Anchoring Hardware. To install mark hole placement of guard, drill into concrete with Masonry Bit, realign guard and secure with anchor bolts.

MODEL	DESCRIPTION	SIZE
BHKIT-1	(1) Masonry Bit	3/4"
BHKIT-2	(2) Anchor Bolts	3/4"D x 4"L
BHKIT-3	(4) Anchor Bolts	3/4"D x 4"L

CORNER PROTECTOR



Scratch Resistant Great for
Indoor or Outdoor Use

- Impact resistant, rust proof
- Shock absorbing hollow construction
- Safety yellow for high visibility
- Polyethylene construction
- Protects and deflects
- 3/8" diameter holes for anchor bolts
(hardware not included)

MODEL	MATERIAL	OVERALL SIZE
BVCP-40	Polyethylene	10"W x 40-1/2"H x 2-1/4"D

POLYETHYLENE WALL PROTECTOR



Protect Your Most
Expensive Asset
Your Building

- Polyethylene construction
- Safety yellow for high visibility
- Protects and deflects
- Scratch resistant
- For Indoor or Outdoor Use
- 3/8" diameter counter sunk holes
for anchor bolts (hardware not included)

MODEL	WIDTH	HEIGHT	PROJECTION
BVBG-48	48"	6-1/4"	2-1/4"

COLUMN & PIPE PROTECTORS

An economical way to protect against damage to structural columns and plant equipment from fork trucks, pallet trucks and other mobile equipment. Highly visible safety yellow finish. Many configurations to choose from. Mounting hardware kits available.

APPLICATIONS	
◆ Support Columns	◆ Parking Lot Signs
◆ Light Posts	◆ Parking Garages
◆ Fixed Jibs & Gantries	◆ Shipping and Receiving Areas

MODULAR GUARD SYSTEMS

Custom Fit To Unlimited Number of Applications

- Designed for quick and easy assembly
- Heavy-duty steel construction
- Safety yellow powder coat finish

Modular guard can easily adjust to most applications. Railing sections are installed and secured to each post with a single bolt. Select from different railing lengths to custom fit your application. Railing systems are made from heavy-duty 3" square steel tubing. Wall mounting posts may be used to secure guard assembly to a wall.

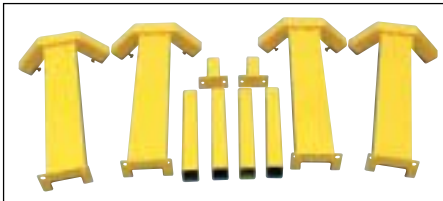

Individual Components are Installed On-Sight



MODULAR GUARD with Wall Mount Posts



MODULAR GUARD provides wrap around protection



CORNER POST
36" high - dual rail
Model BMG-CP-36-2

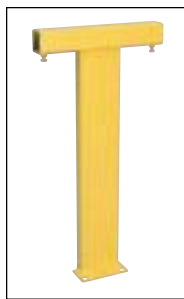

STRAIGHT POST
36" high
Series BMG-SP

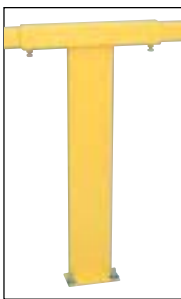

STRAIGHT POST WITH RAIL
Series BMG-SP



RAILING SECTION
Series BMG-R

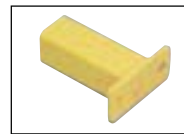

WALL MOUNTING POST
Series BMG-WP

SERIES BMG

MODEL	DESCRIPTION	EFFECTIVE LENGTH	OVERALL LENGTH
BMG-R-4	Railing Section, 3" square tubing	48"	56"
BMG-R-6	Railing Section, 3" square tubing	72"	80"
BMG-R-8	Railing Section, 3" square tubing	96"	102"
BMG-R-10	Railing Section, 3" square tubing	120"	128"
BMG-R-12	Railing Section, 3" square tubing	144"	152"
BMG-CP-36-1	Corner Post, Single Rail, 36" high		
BMG-CP-36-2	Corner Post, Dual Rail, 36" high		
BMG-SP-36-1	Straight Post, Single Rail, 36" high		
BMG-SP-36-2	Straight Post, Dual Rail, 36" high		
BMG-WP-A	Wall Mounting Post - Post Tubing		8"
BMG-WP-B	Wall Mounting Post - Railing Section Tubing		8"
BMG-KIT	Concrete Mounting Kit (includes two anchors)		--

COLUMN GUARDS



Mounting Kit
Model BCPG-ABK

- Prevent costly damage to steel columns, pipe & tubing
- Wrap around protection, two piece installation
- Steel construction with safety yellow powder coat finish

MODEL	HEIGHT	INSIDE WIDTH	INSIDE LENGTH
BCGP-24	24"	20"	20"
BCGP-36	36"	20"	20"
BCGP-48	48"	20"	20"
BCGP-ABK	Mounting Kit (8) 3/4" x 4" Anchor Bolts		

SERIES BCGP

GANTRY / JIB GUARD

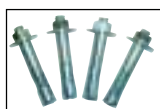

Mounting Kit
Model BCG-ABK

- Prevent costly damage to steel columns, pipe and tubing
- Wrap around protection
- Steel construction with safety yellow powder coat finish
- Ideal for fixed jibs or gantries
- Mounting plate measures 16"W x 13-1/2"D

MODEL	MATERIAL	OVERALL SIZE
BCG-42	Steel	11"W x 10-1/2"D x 42"H
BCG-ABK	Mounting Kit (6) 3/4" x 4" Anchor Bolts	

SERIES BCG

COLUMN CUSHION



- Absorbs impact energy and helps prevent costly damage
- ABS plastic shell can be filled with pea gravel to provide a bean bag effect
- Safety yellow for high visibility
- Easy to install . . . No tools required

MODEL	INSIDE DIAMETER	WIDTH	HEIGHT
BBBC-25	12"	20"	48"

SERIES BBBC

STRUCTURAL COLUMN PROTECTORS



Series BVB



Series BVBS



Octagon Shape for Rebound Availability



Two Piece Construction

- Prevent damage to columns, pipe, and tubing
- UV protected polyethylene construction
- Wrap around protection - Stackable
- Capacity of 7,000 lbs. at 6 m.p.h. (VB series)
- Easy to assemble . . . Fasteners included

MODEL	OVERALL SIZE (W x H)	INSIDE SHAPE	INSIDE OPENING
BVB-6	26" x 42"	Square	6"
BVB-8	26" x 42"	Square	8"
BVB-10	26" x 42"	Square	10"
BVB-12	26" x 42"	Square	12"
BVB-8-10	26" x 42"	Rectangular	8" x 10"
BVB-9R	26" x 42"	Round	9"
BVBS-3	12" x 42"	Square	3"
BVBS-4	12" x 42"	Square	4"
BVBS-5	12" x 42"	Square	5"
BVBS-6	12" x 42"	Square	6"

SERIES BVB & BVBS

RACK GUARDS

SERIES BNPG

LOW PROFILE RACK GUARDS



2 MOUNTING HOLES



Optional Mounting Kit
Model BNPG-ABK

Protect pallet racking and wall corners against damage from fork trucks, pallet trucks and carts with Low Profile Rack Guards. Laser cut components. Quick and easy two-hole installation. High quality safety yellow powder coat finish. Mounting kit available.

LOW PROFILE RACK GUARDS

MODEL	USABLE OPENING SIZE (W x D)	BASE SIZE (W x D)	OVERALL HEIGHT
BNPG4-12	4-1/4" x 1"	8" x 3"	12"
BNPG4-18	4-1/4" x 1"	8" x 3"	18"
BNPG4-24	4-1/4" x 1"	8" x 3"	24"
BNPG4-36	4-1/4" x 1"	8" x 3"	36"
BNPG6-12	6-1/4" x 1"	10" x 3"	12"
BNPG6-18	6-1/4" x 1"	10" x 3"	18"
BNPG6-24	6-1/4" x 1"	10" x 3"	24"
BNPG6-36	6-1/4" x 1"	10" x 3"	36"
BNPG-ABK	Mounting Kit (2) 3/4" x 4" Anchor Bolts		

SERIES BG & BGB

STRUCTURAL RACK GUARDS



4 MOUNTING HOLES



Model BG6-12



Model BG6-12-B



Optional Mounting Kit
Model BG-ABK & BGB-ABK

Economical way to protect against damage to pallet racking and wall corners. Constructed of 6" or 8" structural steel "C" channel. Available with or without a rubber bumper. Easy to install to concrete surface. Four mounting holes for maximum stability. Safety yellow powder coat finish.

STRUCTURAL RACK GUARDS

MODEL	USABLE OPENING SIZE (W x D)	BASE SIZE (W x D)	OVERALL HEIGHT
BG6-12	4-1/2" x 4"	7-5/8" x 6"	12"
BG6-18	4-1/2" x 4"	7-5/8" x 6"	18"
BG6-24	4-1/2" x 4"	7-5/8" x 6"	24"
BG6-36	4-1/2" x 4"	7-5/8" x 6"	36"
BG8-12	6-1/2" x 4"	9-5/8" x 6"	12"
BG8-18	6-1/2" x 4"	9-5/8" x 6"	18"
BG8-24	6-1/2" x 4"	9-5/8" x 6"	24"
BG8-36	6-1/2" x 4"	9-5/8" x 6"	36"
BG-ABK	Mounting Kit (4) 3/4" x 4" Anchor Bolts		

STRUCTURAL RACK GUARDS WITH RUBBER BUMPER

MODEL	USABLE OPENING SIZE (W x D)	BASE SIZE (W x D)	OVERALL HEIGHT
BG6-12-B	4-1/2" x 4"	7-5/8" x 6"	12"
BG6-18-B	4-1/2" x 4"	7-5/8" x 6"	18"
BG6-24-B	4-1/2" x 4"	7-5/8" x 6"	24"
BG6-36-B	4-1/2" x 4"	7-5/8" x 6"	36"
BG8-12-B	6-1/2" x 4"	9-5/8" x 6"	12"
BG8-18-B	6-1/2" x 4"	9-5/8" x 6"	18"
BG8-24-B	6-1/2" x 4"	9-5/8" x 6"	24"
BG8-36-B	6-1/2" x 4"	9-5/8" x 6"	36"
BGB-ABK	Mounting Kit (4) 3/4" x 4" Anchor Bolts		

RACK GUARD WITH RUBBER BUMPER INSERT



POWDER
COATED
TOUGH™

NO MOUNTING HOLES



Each unit includes a bumper insert, 1/2" thick x 24" high

Protect pallet racking with durable wrap around protection. Fits pallet racking measuring 3"W x 3-3/4"D. Increase pallet rack column strength on impact by over 100%. Includes rubber bumper insert and hardware. Easy to install with wrench or socket, no concrete drilling required. Safety yellow powder coat finish.

MODEL	USABLE OPENING (W x D)	OVERALL HEIGHT
BRUD-24	3" x 3-3/4"	24"

SERIES BRUD-24

SERIES BPCG

SERIES BVRP-18

SERIES BDSG & BVPP

PLATE CORNER GUARDS

POWDER
COATED
TOUGH™



3 MOUNTING HOLES



Protect busy corners, expensive machinery and personnel with 90° perpendicular protection. "Safety First" promotion reminds personnel of the number one priority. Yellow powder coat finish. Mounting kit available, model BPGC-ABK.

MODEL	MATERIAL	OVERALL SIZE (H x L)	SIDE HEIGHT
BPCG-16	Steel (1/4)	16" x 16"	8"
BPCG-24	Steel (1/4)	24" x 24"	12"
BPCG-24-A	Aluminum (1/8)	24" x 24"	12"
BPGC-ABK	Mounting Kit (3) 3/4" x 4" Anchor Bolts		

RACK PROTECTOR



Protect pallet racking from damage with rugged polyethylene protectors. Deflection properties of polyethylene are ideal for guarding applications. Easy installation with quick velcro mount or concrete lag to the ground, hardware included. Safety yellow color increases visibility.

MODEL	USABLE OPENING SIZE	OVERALL SIZE (W x L)	OVERALL HEIGHT
BVRP-18	3-1/2"	4-1/2" x 8"	18"

DOWN SPOUT GUARD & PIPE PROTECTOR



Poly Protector
Model BVPP-5R



Steel Guard
Model BDSG-48

Protect down spouts and pipes that run along buildings from damage caused by fork trucks, vehicles and mowers. Our Steel Down Spout Guards fit around standard down spouts. Our Poly Pipe Protector fits pipes up to 5" diameter. Easy bolt on installation. Choose steel for optimum strength or polyethylene for protection with deflection.

MODEL	MATERIAL	INSIDE (W x D)	OVERALL (W x D x H)
BVPP-5R	Polyethylene	5"	12" x 6" x 42"
BDSG-48	Steel	11-1/2" x 10-1/2"	15-1/2" x 10-3/4" x 42"

STEEL SQUARE SAFETY RAILING

STEEL SQUARE SAFETY RAILING

DESIGNED TO MEET OSHA & ANSI STANDARDS!



POWDER COATED TOUGH

An economical way to protect people and machinery. Applications include loading docks, floor openings, walkways, and mezzanines. Highly visible safety yellow powder coat finish. Available with or without toeboards as application requires.

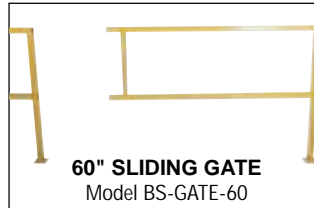
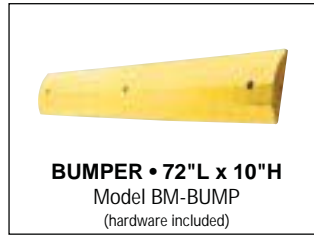

RIGID SECTION WITHOUT TOEBOARD

MODEL	OVERALL LENGTH	OVERALL HEIGHT	TUBING O.D.
BSQ-48	48"	42"	1-3/4"
BSQ-72	72"	42"	1-3/4"
BSQ-96	96"	42"	1-3/4"
BSQ-120	120"	42"	1-3/4"

RIGID SECTION WITH TOEBOARD

MODEL	OVERALL LENGTH	OVERALL HEIGHT	TUBING O.D.
BSQ-48-TB	48"	42"	1-3/4"
BSQ-72-TB	72"	42"	1-3/4"
BSQ-96-TB	96"	42"	1-3/4"
BSQ-120-TB	120"	42"	1-3/4"



WIRE MESH FOR HANDRAIL

MODEL	OVERALL LENGTH	OVERALL HEIGHT	WEIGHT (POUNDS)
BWM-48	48"	22"	18
BWM-72	72"	22"	28
BWM-96	96"	22"	36
BWM-120	120"	22"	43

CONNECTION SECTION TUBING

MODEL	OVERALL LENGTH	TUBING O.D.	WEIGHT (POUNDS)
BCESC-48	48"	1-1/2"	14/Pair
BCESC-72	72"	1-1/2"	18/Pair
BCESC-96	96"	1-1/2"	22/Pair
BCESC-120	120"	1-1/2"	25/Pair

ADJUSTABLE STEEL SAFETY RAILING



The Adjustable Railing can be used to create walking paths or as a sliding gate for continuous run handrail systems. 1-3/4" O.D. square tubing is painted safety yellow for high visibility. Unit stands 42" high and has a 21" mid rail. Optional 96" long toe board is available. Retracted length is 96" and extended length is 168".

MODEL	DESCRIPTION	SERVICE RANGE	WEIGHT
BASR-96	No Toeboard Included	96" to 168"	54 lbs.
BASR-96-4-TB	Includes 4"H x 96"L Toeboard	96" to 168"	61 lbs.

STEEL PIPE SAFETY RAILING

STEEL PIPE SAFETY RAILINGS

DESIGNED TO MEET OSHA & ANSI STANDARDS!

Handrails are 42" high with a 21" mid rail. These durable railings are made of 1-5/8" O.D. schedule 40 pipe (1" I.D.). Mounting options include socket sleeves for flush concrete mount, barricade bases, or cast steel sockets for convenient handrail removal. Sockets accept wood 2" x 4" or 2" x 6" when toe boards are required.

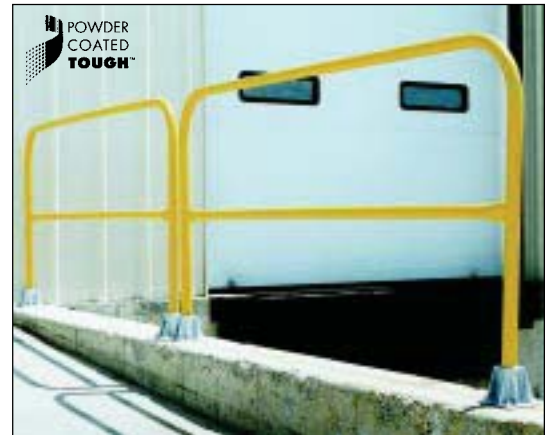

MODEL	DIAMETER	HEIGHT	LENGTH
BVDKR-2	1-5/8"	42"	24"
BVDKR-3	1-5/8"	42"	36"
BVDKR-4	1-5/8"	42"	48"
BVDKR-5	1-5/8"	42"	60"
BVDKR-6	1-5/8"	42"	72"
BVDKR-7	1-5/8"	42"	84"
BVDKR-8	1-5/8"	42"	96"

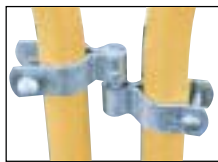

CONNECTOR KIT
includes 2 male and 2 female connectors
Model BVDKR-CON



SINGLE SOCKET
for surface mounting,
accepts wood for toeboards
Model BVDKR-P101

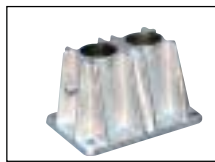

DOUBLE SOCKET
for surface mounting
sockets are 4" high
Model BVDKR-P102

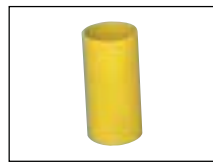

METAL SLEEVE
Measures 4" high x 2" O.D.
For flush concrete mount
Model BVDKR-P107

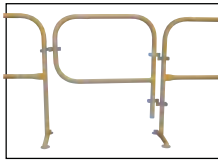

3 FT. or 4 FT. GATE
Model BVDKR-G3 or
Model BVDKR-G4

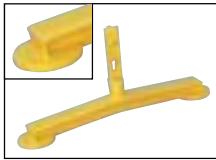

BARRICADE BASE WITH FEET
Model BVDKR-BB-F

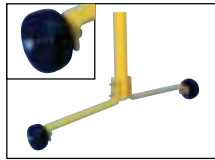

BARRICADE BASE WITH WHEELS
Model BVDKR-BB-W



ANCHOR BOLTS
(4) 3/8" x 3"
Model BVDKR-KIT



DOUBLE SOCKET

Conserve space when surface mounting a long run of railing. Accepts wood 2 x 4's or 2 x 6's when toeboards are required. Model BVDKR-P102

SERIES BVDKR

CROWD CONTROL INTERLOCKING BARRIER



Easy to Connect for Continuous Runs

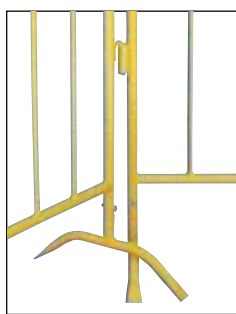

Interlocking yellow portable railing has many commercial and industrial applications. Easy to move to meet changing needs. Upright bars are spaced at 5-1/4" intervals. Supporting frame is 1-3/8" diameter.

MODEL	OVERALL LENGTH	OVERALL HEIGHT
BPRAIL-102	102"	40-1/4"

SERIES BPRAIL-102

STAINLESS STEEL RAILING



Railing can be Moved Quickly and Easily or Anchored

Keep guests flowing in restaurants, schools, offices or other indoor and outdoor applications. The unique contemporary design offers a clean look wherever the railing is placed. Sections can be connected by attaching the chains at each end. No anchoring is needed due to cast steel base liner.

MODEL	OVERALL SIZE (L x H)	BASE DIAMETER
BSSRAIL-96	96" x 42"	12"

SERIES BSSRAIL-96

GUIDANCE BARRIERS

PERSONNEL GUIDANCE BARRIERS

SERIES BWEB

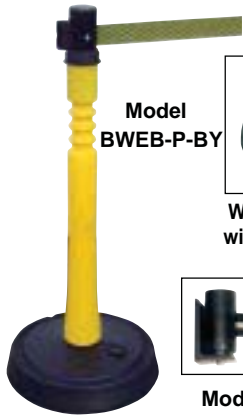

Model BWEB-P-BY



Weight unit down with sand or water

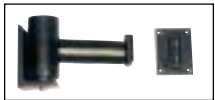

Model BWEB-W



Model BWEB-P

Keep personnel and customers flowing with economical personnel guidance barriers. Perfect for restaurants, offices, hospitals and schools. The poly strap, model BWEB-P-BY, extends out 132" and is ideal for both indoor and outdoor applications. The fabric strap, model BWEB-P and BWEB-W, extends 72" and is ideal for indoor applications.

MODEL	DESCRIPTION
BWEB-P-BY	38"H Poly Pedestal Mount (black/yellow)
BWEB-P	40"H Post with Web & Self Reeling Top (b/w)
BWEB-W	Wall Mounted with Receptacle (black/white)

SIGN STAND

SERIES BS-STAND



Mount Your Sign at a Variety of Heights



Features Removable Post and Weighted Base

Ideal for all types of signs. Surface mounted with a weighted base, includes (3) holes, 9/16" diameter with 1-3/8" diameter counter-bore for permanent mounting. Removable post will accept virtually any sign (sign & mounting hardware not included). Steel construction with painted black finish (BS-STAND) or chrome finish (BS-STAND-CH) available.

MODEL	OVERALL HEIGHT	BASE DIAMETER	PIPE DIAMETER
BS-STAND	48"	18"	1-7/8"
BS-STAND-CH	48"	18"	1-7/8"

FREESTANDING OR INTERLOCKING BARRICADE

SERIES BYCM-41



Support Stand for Freestanding Units

Warn people of safety hazards ahead such as open manholes, wet/icy floors or spills. Lightweight and easy to set up and break down for temporary hazards. Features a support stand for freestanding units or interlocking capabilities for those larger jobs. Constructed from a highly visible yellow polyethylene.

MODEL	OVERALL HEIGHT	INSIDE WIDTH	WEIGHT (POUNDS)
BYCM-41	41"	31"	6

TRAFFIC CONES

SERIES BTC-30

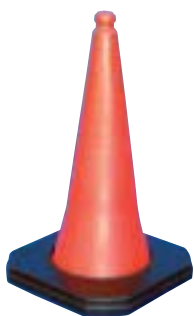

Removable Weighted Bottom

Highly visible from far distances these safety cones are ideal for over the road trailers, public works and police departments. The durable all weather cones are constructed of PVC and feature a removable weighted bottom. Units won't fade or crack and bounce back to shape when crushed.

MODEL	OVERALL HEIGHT	BASE WIDTH	BASE LENGTH
BTC-30	30-3/4"	17-3/4"	17-3/4"

GATES

SERIES BEXGATE

SERIES BMEZZ-200

SERIES BVSSG & BVPPFG

EXPAND-A-GATE

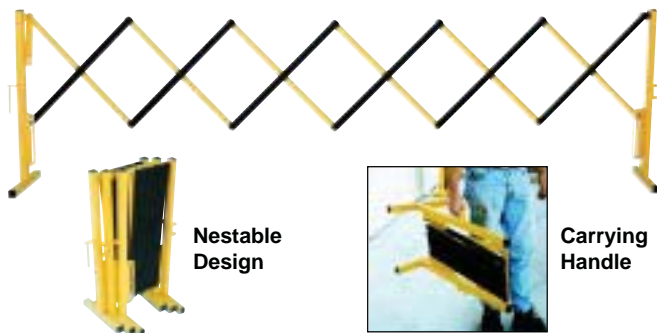

Nestable Design

Carrying Handle

Designed to set up quickly wherever and whenever they are needed. Ideal for preventing potential accidents. Lightweight design allows personnel to quickly retrieve the gate and limit access to unsafe areas. Smooth operating scissor action. Interlocking and nestable.

MODEL	COLLAPSED WIDTH	EXPANDED WIDTH	OVERALL HEIGHT
BEXGATE-30	14-1/2"	144"	37"

SAFETY MEZZANINE GATE

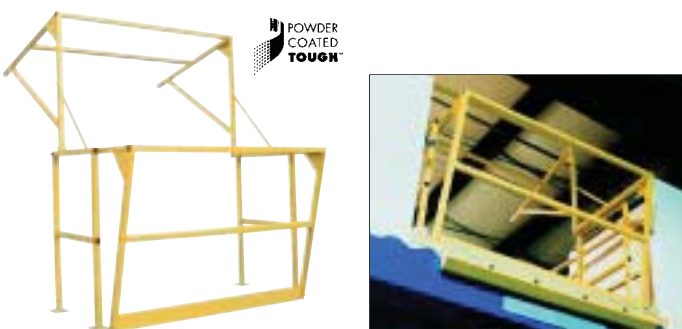

POWDER COATED TOUGH

The Mezzanine Gate provides an OSHA required 42" high handrail, 21" mid rail and 4" high kickplate for mezzanines without sacrificing load accessibility. The gate rotates to allow loading and unloading of maximum 48" wide x 48" high pallets. Safety yellow powder coat finish.

MODEL	OVERALL HEIGHT	OVERALL WIDTH	OPENING DEPTH
BMEZZ-200	66"	70"	80"

SINGLE & DOUBLE FOLDING GALVANIZED GATES



Double Style Pictured

ADDED SECURITY WITHOUT SACRIFICING VISIBILITY OR AIR CIRCULATION

- 15 Gauge Steel
- U-Type Channel
- Steel Casters
- Galvanized finish
- Single gates are shipped locking right
- Portable and Door Scissor Gates available in a variety of widths and heights

Secure outside access during the day and added security at night with heavy duty 15 gauge steel folding gates. Durable steel casters allow operator to quickly and fully retract when not in use. Easy installation! Lock is located on right side on single gates. Galvanized for durability.

SINGLE STYLE

MODEL	USABLE WIDTH (FT.)	COLLAPSED HEIGHT (FT.)	IN USE HEIGHT (FT.)
BVSSG-465	3 to 4	6-1/2	6
BVSSG-475	3 to 4	7-1/2	7
BVSSG-485	3 to 4	8-1/2	8
BVSSG-565	4 to 5	6-1/2	6
BVSSG-575	4 to 5	7-1/2	7
BVSSG-585	4 to 5	8-1/2	8
BVSSG-665	5 to 6	6-1/2	6
BVSSG-675	5 to 6	7-1/2	7
BVSSG-685	5 to 6	8-1/2	8
BVSSG-765	6 to 7	6-1/2	6
BVSSG-775	6 to 7	7-1/2	7
BVSSG-785	6 to 7	8-1/2	8
BVSSG-865	7 to 8	6-1/2	6
BVSSG-875	7 to 8	7-1/2	7
BVSSG-885	7 to 8	8-1/2	8
BVSSG-975	8 to 9	7-1/2	7

DOUBLE STYLE

MODEL	USABLE WIDTH (FT.)	COLLAPSED HEIGHT (FT.)	IN USE HEIGHT (FT.)
BVPFG-865	6 to 8	6-1/2	6
BVPFG-875	6 to 8	7-1/2	7
BVPFG-885	6 to 8	8-1/2	8
BVPFG-1065	8 to 10	6-1/2	6
BVPFG-1075	8 to 10	7-1/2	7
BVPFG-1085	8 to 10	8-1/2	8
BVPFG-1265	10 to 12	6-1/2	6
BVPFG-1275	10 to 12	7-1/2	7
BVPFG-1285	10 to 12	8-1/2	8
BVPFG-1465	12 to 14	6-1/2	6
BVPFG-1475	12 to 14	7-1/2	7
BVPFG-1485	12 to 14	8-1/2	8
BVPFG-1665	14 to 16	6-1/2	6
BVPFG-1675	14 to 16	7-1/2	7
BVPFG-1685	14 to 16	8-1/2	8
BVPFG-1875	16 to 18	7-1/2	7

MISCELLANEOUS PROTECTORS

OVERHEAD DOOR TRACK PROTECTOR

SERIES BDSP



Protect the tracks of overhead doors from fork trucks, pallet trucks or any type of traffic with these solid steel constructed, economical Overhead Door Track Protectors. The base plate is 6" square with a 3" notch out and 3/4" diameter mounting holes. Safety yellow powder coat finish for long term wear.

MODEL	HEIGHT	BASE PLATE SPECIFICATIONS	MOUNTING HOLE DIAMETER
BDSP-24	24"	6" Square with a 3" notch out	3/4"
BDSP-36	36"	6" Square with a 3" notch out	3/4"
BDSP-48	48"	6" Square with a 3" notch out	3/4"
BDSP-ABK	Mounting Kit (3) 5/8" x 4" Anchor Bolts		

OVERHEAD DOOR PROTECTOR

SERIES BODG



Push Snap Button In and Extend Pole to Desired Length



Glow in the Dark Stripes

Protect overhead doors from damage from forklifts. Extendable fiberglass pole hangs in front of overhead door by two chains. Unit is safety yellow and comes with reflective and glow in the dark stripes. Additional sizes with beeper and strobe also available.

MODEL	DESCRIPTION	OVERALL SIZE
BODG-10	Fiberglass Overhead Door Guard	1-1/4"W x 132"L
BODG-MB	Steel Mounting Brackets (one pair)	

DOWNSPOUT DRAIN WATER DISPERSER

SERIES BDRAIN-DD



Self-Tapping Screws Standard

The Drain Water Disperser attaches to most standard downspouts. Easy installation, fits simply up and around the end. During a rainstorm water collects at the bottom of drains, ruining grass and landscape. This device disperses the water outward and evenly over a larger area. Constructed of maintenance free aluminum.

MODEL	OVERALL HEIGHT	OVERALL WIDTH	DEPTH
BDRAIN-DD	6-1/2"	12"	8"

BUMPER WRAP

SERIES BBW



Bumper Wrap is a flexible UV coated protective wrap for use in warehouses, drive-thru's, fueling stations and municipal barrier applications. Made of a non-marring, highly visible flexible vinyl. Protect vehicles from impact and scraping damage while protecting posts from constant abuse.

MODEL	DESCRIPTION	OVERALL SIZE	PROJECTION
BBW-4.5-KIT	WRAP KIT FOR 4-1/2" DIA. BOLLARD	12"H x 4-1/2"L	3/8"
BBW-5.5-KIT	WRAP KIT FOR 5-1/2" DIA. BOLLARD	12"H x 5-1/2"L	3/8"
BBW-480	40 FOOT BULK ROLL	12"H	3/8"
BBW-TIE-24	(4) 24" CABLE TIE		
BBW-TIE-36	(4) 36" CABLE TIE		
BBW-TIE-48	(4) 48" CABLE TIE		