

GEARBOSS[®]

by Wenger[®]

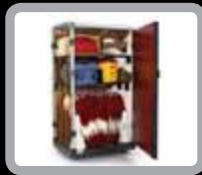

GEARBOSS[®]
HIGH-DENSITY STORAGE



SPORTCART[™]



GEARBOSS II[™]
HIGH-DENSITY STORAGE



ADJUSTABLE
SHELVING



CUSTOMIZABLE
WOOD LOCKERS



AIRPRO[®] LOCKERS



TRANSPORT[®] CART



MOBILE KIOSK

ATHLETIC PRODUCTS CATALOG
2010-2011



Owatonna High School, Owatonna, Minnesota



Germantown High School, Germantown, Wisconsin

CHAOS VS. ORDER

ON EVERY LEVEL



Dallas Cowboys, Irving, Texas



Monmouth University, West Long Branch, New Jersey



Livingston High School, Livingston, New Jersey

GearBoss® by Wenger is a complete, state-of-the-art system designed to help with all aspects of your athletic program. From lockers, to storage, to equipment transport and fund-raising solutions, GearBoss products save you time, space, and effort. They're flexible and customizable so your system can change as your needs change. Plus, we'll work with you every step of the way to make sure you get exactly the right system—nothing more, nothing less.

GEARBOSS® INNOVATIONS ARE DRIVEN BY THESE KEY PRINCIPLES:

SPACE



High-density storage and room design services for maximizing every inch of space.

ORGANIZATION



Keep track of your equipment and apparel easily with storage and locker rooms that get in order and stay in order.

SANITATION



Superior ventilation and anti-microbial surfaces help equipment stay clean, dry and germ-free.

PRIDE



Equipment and locker rooms that set you apart and reflect your team spirit.

MOBILITY



Haul equipment and apparel wherever you need it, without hassle.

FLEXIBILITY



Storage systems and custom lockers that adapt to your changing needs.

SECURITY



Lockable doors and side panels keep equipment safe and secure.

We designed GearBoss® Athletic Storage Systems with one thing in mind: making your job, and your life, easier. That's why our storage systems have been created with the help of athletic directors, coaches and equipment managers—people who know what works. Clutter has finally met its match.



GearBoss II High-Density Storage

A simplified high-density storage system designed with value in mind

The newest high-density storage system from Wenger joins our successful premium carts in creating athletic equipment storage rooms that make better use of available space. With this new system you get the same space-saving organization as our premium carts in a simplified system with a budget-friendly price. You will gain more control over the time and money lost to poor organization, lax security and misplaced inventory. This storage system is simply a better way to care for your equipment investments.



www.wengercorp.com/athletics • 1.800.4WENGER (493.6437)

TABLE OF CONTENTS

ENVIRONMENTAL AWARENESS	PAGE 4
NEW CONSTRUCTION ASSISTANCE	PAGE 5
TEAM LOCKERS	PAGE 6
CUSTOMIZABLE WOOD LOCKERS	PAGE 8
AIRPRO™ LOCKERS	PAGE 12
GEARBOSS HIGH-DENSITY STORAGE	PAGE 16
X-CART™	PAGE 18
TEAM CART™	PAGE 20
SPORTCART™	PAGE 22
GEARBOSS II HIGH DENSITY STORAGE	PAGE 24
ADJUSTABLE SHELVING	PAGE 26
OPTIONS	PAGE 30
MOBILE SPECIALTIES	PAGE 36
TRANSPORT™ CART	PAGE 38
ONBOARD® CARGO CART	PAGE 40
RACK 'N ROLL®	PAGE 40
MOBILE KIOSK	PAGE 42
HYDRATE® CART	PAGE 44
FIELD PODIUM	PAGE 45
COMPANION PRODUCTS	PAGE 46
PERFORMANCE PRODUCTS	PAGE 47



GEARBOSS®
by Wenger®

Every year we get greener and greener, and help more and more of our customers do the same.

For as long as we've been developing high-quality, durable products to meet the needs of our customers, we've also been exploring ways to be better stewards of the environment we share. Here are some of the ways we're making Wenger Corporation more environmentally sound and sustainable, as well as efforts we're making to help you achieve your own green goals:

Conserving resources in our buildings

- Emphasis on using recycled paper
- Concerted effort to deliver information electronically
- Advanced low-consumption plant lighting
- Smart HVAC central control system

Recycling everywhere we can

- Regular facility-wide collection, in 2009 accounting for more than 917 tons of recycled material
- Sawdust-for-animal-bedding giveaways
- Routine collection of steel and aluminum dropoff, and all oils used in manufacturing
- Opportunities for employees to bring in difficult-to-recycle items
- Manufacturing waste materials are re-used in new products and new packaging

Creating environmentally friendly products

- Optional environmentally sensitive core material in Instrument Storage Cabinets
- High-efficiency electronic ballasts in SoundLok™ Sound-Isolation Rooms
- Wax coating Student Chair Tablet Arm Desks
- Powder paint finishing
- Super-insulated drying and curing ovens
- Green cleaning agents and a non-metallic conversion coating
- Manufacturing cooling and rinse water reuse
- Residual material in aerosol cans is burned or captured and carefully disposed
- Securing properly sized raw materials eliminates waste
- Computer-optimized cutting processes improve yield
- ISO quality-improvement tools reduce scrap
- Wenger delivery trucks are built with the latest clean-burning diesel emission-control technologies

Using environmentally friendly packaging

- Stretch-wrapping eliminates corrugated waste
- Post-installation packaging is returned and reused or recycled
- Pallets are reused or remanufactured
- Instant foam packaging — free of CFCs and HCFCs — is used where possible

Simplifying the LEED Certification process

Wenger recognizes and supports The Leadership in Energy and Environmental Design (LEED) rating system. In fact, as a member of the LEED Construction Initiative, Wenger has the insights and experience to make the LEED certification process easier for our customers to understand and attain, and that makes for a greener world all around.

Implementing the philosophy of the USGBC

As a member of the US Green Building Council, the group that developed LEED, Wenger is dedicated to fulfilling USGBC's mission to promote green building practices. We understand and embrace the principles behind the USGBC and its LEED Initiative, which is your guarantee that once you start down the road to LEED certification, you will be officially and enthusiastically supported every step of the way. www.usgbc.org



Meeting FSC CoC certification

Recognized by LEED, the Forest Stewardship Council is an independent, not-for-profit organization established to promote the responsible management of the world's forests. FSC Chain-of-Custody (CoC) certified products carry a label certifying that FSC-tracked material throughout the production process — your guarantee that when you buy these products you are making a socially and environmentally responsible purchasing decision. Wenger certification is pending. www.fsc.org

Meeting GREENGUARD certification

The mission of The GREENGUARD Environmental Institute (GEI) is to protect human health and quality of life through programs that help reduce chemical exposure and improve indoor air quality. To date, GREENGUARD has certified Wenger Chairs, Stands, Instrument, Garment, and Specialty Storage Cabinets, and GearBoss Storage Carts, and we look to certify more products as we progress. www.greenguard.org



Tailoring a plan to fit your needs

No single solution suits all companies. So call us. Let's talk about where you are environmentally and where you'd like to be. We have been thinking green throughout our 65-year history and have unique experience and expertise to help you achieve any and all of your own green initiatives. And we're ready to start today.



This catalog is printed with environmentally friendly Enviro/Tech ink with a renewable resource content of 27.3 percent, nearly four times the published 7 percent minimum soy-ink requirement. In addition to soy, Enviro/Tech inks include cottonseed, vernonia, sunflower, tung, linseed, canola, and vegetable oils, and pine resin.

We are also proud to say this catalog is 100 percent recyclable.



Look for this symbol throughout our catalog to indicate products that are environmentally friendly

FREE RESOURCES to assist you in creating your space.



Call Your GearBoss Representative for more expertise in planning athletic spaces.



Getting started

When you call, be ready to discuss your athletic programs and the dimensions of your storage areas. We'll quickly provide options and layouts to organize your space. (see image) Your GearBoss representative has the experience and knowledge to lead you through every step of the process.

FREE layout planning

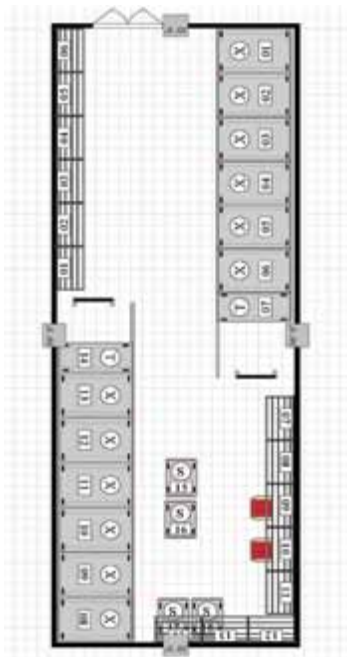

- Go online and fill out a GearBoss request form to get a project-specific layout.

What Can GearBoss Do For You?

Your day is filled with many things to juggle. Let the GearBoss team help you prepare and simplify the tasks that come with any new construction or renovation project.

Early input and consultation

GearBoss by Wenger brings you the expertise of our involvement in thousands of new construction and renovation projects around the world. We can help you benchmark your facility so you can plan early for the most economic use of the space you have. Call on the GearBoss team as soon as a project is on the horizon. Getting started early is one key to success.

Space strategies

We bring you strategic insights into the workings of athletic spaces. Equipment rooms, laundry facilities, coaches offices and locker rooms all have unique requirements that your GearBoss representative will outline for you. We can help you define your program's needs and goals.

Presentations and communication with architects and influencers

Your GearBoss representative can provide you with the communication tools you need when discussing your project with architects, administrators and alumni. We have a wide array of literature including planning guides, space and cost comparisons and case studies to assist you in securing approval on your project. Ahead of any meeting with architects or administrators, turn to the GearBoss team for presentation support and materials.

Layouts and execution

Our high-density storage solutions are designed to address space allocation, traffic flow and equipment management. Your representative will work with you to highlight spaces that can now be used for other purposes and create room layouts that meet the needs of your specific program. Turn over the details of getting the right equipment storage and locker room design to the GearBoss team.

CALL 1.800.4WENGER (493-6467) for our free literature today or visit www.wengercorp.com for more information.



TEAM LOCKERS



*Monmouth University,
West Long Branch, New Jersey*



"We wanted recruits and players to feel good about what they see – it's a "Wow!" feeling when you walk in – and our GearBoss lockers really accomplish this. They are first-class – we're very impressed! The available options were also very attractive; other companies didn't offer these upgrades. Wenger did an outstanding job installing more than 340 wood lockers in our Multi-Purpose Athletic Center."

– Jeff Stapleton, Senior Associate Athletic Director for Internal Operations, Monmouth University, West Long Branch, New Jersey



Old Dominion University, Norfolk, Virginia

A TEAM ROOM THAT INSPIRES GREATNESS

Your facilities reflect your tradition as well as your expectations for future success. The one area where this matters most, the area that impacts your players every day, is the team room. More than just a locker room, your team room needs to inspire, recruit and function. Both the GearBoss customizable wood and AirPro lockers will help you create a first-class team room that will set your program apart.



CUSTOMIZABLE WOOD LOCKERS

REDEFINING THE LOCKER ROOM

Investing in a quality team room lets players, coaches and staff know that your program is valued. It inspires performance, promotes pride in the whole organization and helps recruit new talent. The team room needs to make a first-class statement while also maintaining superior functionality. GearBoss lockers are designed to create a lasting impression as well as a comfortable, clean, long-lasting environment. They're an important part of creating a team room that lives up to your program, your facility and your expectations. Our wood lockers offer a wide range of features and options that can give your new team room a unique identity. We'll work with your coaches and interior designers to create the custom wood lockers that best fit your athletes' needs and your designers' vision.



Lockable storage



Back-lit fans

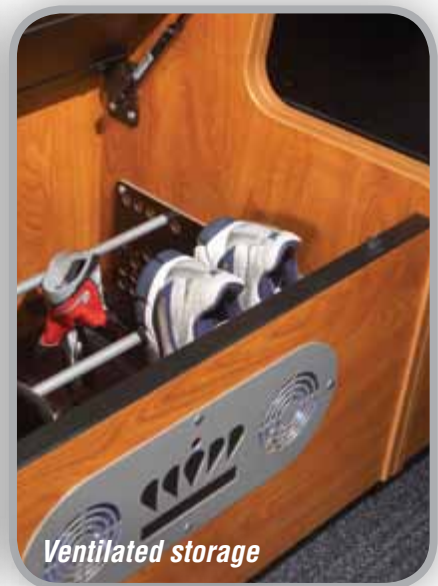

Ventilated storage

Take one more step toward a more sanitary facility

The closed-cell structure of poly-laminated surfaces are standard on every GearBoss locker and are easier to clean and more impervious to moisture and microorganisms. They are also treated with antimicrobial, technology which will last for the life of the product, creating a hostile, lethal surface for bacteria, viruses, mold and mildew.*

**Available on polyester laminates but may not be available on some custom laminates or real wood veneers.*

Airflow improves cleanliness and comfort

GearBoss wood lockers are raised up off the floor to allow air to flow around the unit. In addition, the ventilated storage under the seat also allows air to move through the footlocker, keeping the space more sanitary. Optional fans in the footlocker and on the shoulder pad and helmet topper dry gear faster. This decreases odor and keeps equipment more sanitary—plus it really adds to your players' comfort and performance.

Designed to endure

GearBoss knows that poly-laminated surfaces and PVC edge-banding outperforms wood veneers and cabinet-type construction. Bolt-through construction is critical for connections, hooks and doors that don't pull out. We've made every component modular so if a door, panel or seat gets damaged, the part can be easily removed and replaced without destroying glue, dowels or adjacent components.

CUSTOMIZABLE WOOD LOCKERS

THE TEAM ROOM HAS EVOLVED TO BE SO MUCH MORE THAN A LOCKER ROOM.

WE START WITH THE STANDARD DESIGN SPECS...

Lockers are manufactured with a thermofused composite wood core and PVC edge-banding. Antimicrobial, polyester laminate finish is also applied. The 16-gauge, powder coated base and zinc-plated levelers raise the unit from 1" (2.5 cm) to 2.5" (6.3 cm), improving air flow and access for cleaning. Lockers attach to the wall at top and bottom as well as with low-profile, chrome-plated through connectors from locker to locker. A thermoformed, ABS nameplate is used along with 10-gauge, powder coated garment hooks. The floor plate is removable for easy access to cleaning under the lockers. All components are replaceable and the entire locker can be pulled out and reconfigured.

...AND THEN WE ALLOW YOU TO CUSTOMIZE YOUR ORDER FROM THERE

GearBoss lockers come in widths, ranging in 2" (5 cm) increments, from 18" (61 cm) to 36" (91 cm) with sides that are straight, cut back or contoured. Various options include a programmable locking cubby, or cubby with a slide bolt for a padlock. Optional features include a lighted name plate, duplex outlet and up to 4 active airflow fans (2 in front of the foot locker and 2 on the shoulder pad topper). Fans can be in the footlocker or vented out the back as well as in the shoulder pad topper for optimal drying efficiency. Choose either a fixed or hinged seat with closed or open footlocker and drying racks. Complete your look with expanded attic storage, hook and garment bar combinations and hundreds of finish options. We can even incorporate your ideas into your own team's unique design — just call us to discuss.



LAMINATE OPTIONS

Wenger offers a variety of standard laminates which provide great aesthetics, the best costs and short lead times. For additional finish options to match your school tradition or interior design, contact your representative.

Laminates are also treated with antimicrobial, nano-silver technology which will last for the life of the product, creating a hostile, lethal surface for bacteria, viruses, mold and mildew.*

**Available on hundreds of GearBoss polyester laminates but may not be available on some custom laminates or real wood veneers.*



GRAPHITE



PEBBLE



OYSTER



CHERRY



SOLAR OAK



FUSION MAPLE



WENGER MAPLE

JUST A FEW OF THE MANY CONFIGURATIONS



CUT BACK (as shown)

- Football configuration
- Cherry finish color
- Football topper unit with fans
- Lighted nameplate
- Cubby door with digital lock
- Six hooks
- Hinged seat with fans providing active airflow



CONTOUR CUT (as shown)

- Multi-sport and coach configuration
- Wenger maple finish color
- Attic extension with open cubbies
- Lighted nameplate
- Cubby door with digital lock
- Four hooks and a garment bar
- Hinged seat and vented footlocker
- Vent plate with school logo



STRAIGHT CUT (as shown)

- Multi-sport/visitor configuration
- Graphite finish color
- Nameplate location at top of locker
- Open cubbies
- Four hooks and a garment bar
- Fixed seat with open footlocker
- Shelf in footlocker



AIRPRO™ LOCKERS

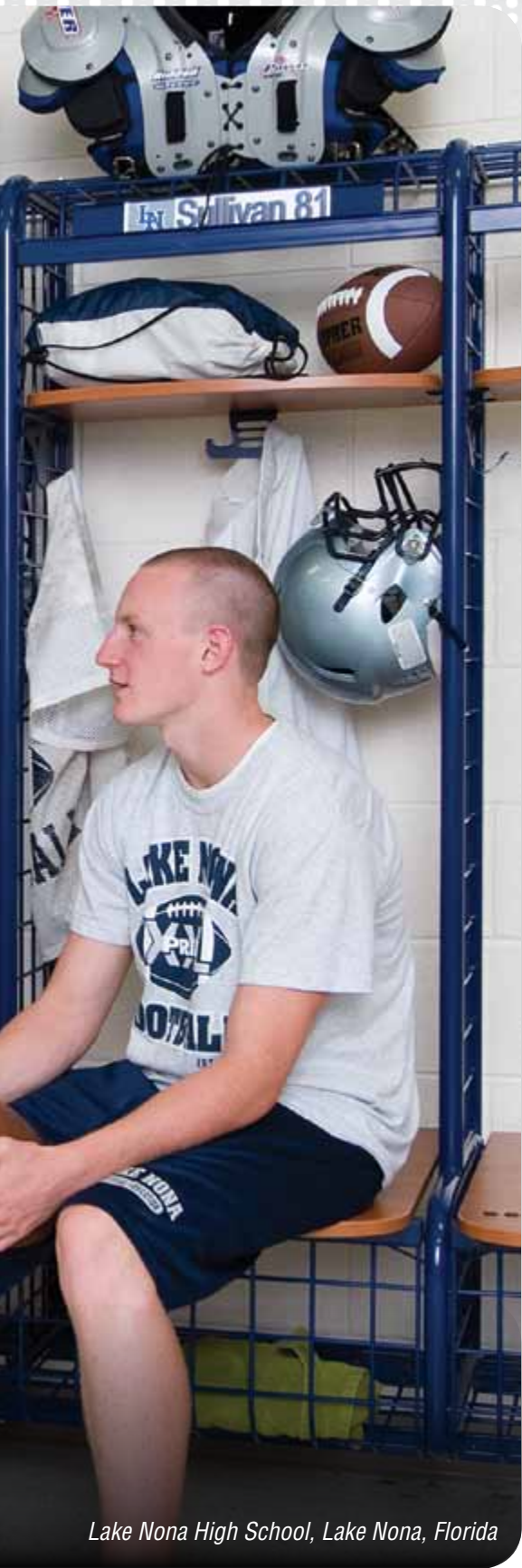

Lake Nona High School, Lake Nona, Florida



"GearBoss provided professional-looking, top-of-line lockers that fit within our budget. The quality of the AirPro lockers is unmatched. GearBoss has assisted our program in reaching the next level and creating a sense of pride among our student athletes."

*– Andy Chiles, CMAA, Athletic Director,
Lake Nona High School, Orlando, Florida*

AIRPRO™ LOCKERS

A new space-saving locker design that keeps your gear more sanitary

Designed with integrated benches, AirPro lockers free up valuable real estate, creating extra floor space and a more open feel. Plus, AirPro's durable metal grid construction allows for maximum airflow and minimum hassle. They're easy to clean and as a result, more sanitary. With new AirPro lockers, your team room problems are solved.





Grille



No Door



No Door
(with back panel)



Wood Door

AIRPRO™ LOCKERS

GET ON THE GRID.

Our AirPro lockers are a big part of creating a team room that stands apart. A room that gets away from the dingy commercial look of sheet metal solutions. A room that is infinitely easier to clean and, as a result, more sanitary, faster drying and better smelling. A team room that carries a high-end aesthetic reflecting your pride and traditions. A team room that saves on floor space, with integrated benches that open up your rooms and provide for more effective team meetings. Sheet metal hallway lockers and gym lockers simply can't match these features or create a team room environment where varsity traditions are in a class of their own.



"The AirPro Lockers are working out great – the kids love them and are taking good care of them. They look good and are very functional – they're everything we wanted. We also appreciate the helmet/shoulder pad toppers and security of being able to lock valuables underneath the seat."

*- Phil Ditka, Football Coach
Germantown High School,
Germantown, Wisconsin*

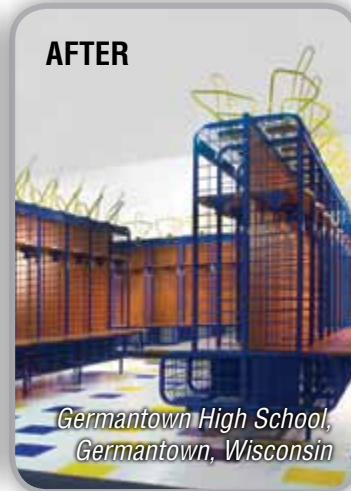

*Germantown High School,
Germantown, Wisconsin*

FEATURES

- Powder coated antimicrobial painted finishes are available in 13 standard colors to match your school tradition. Seats, shelves and wood back panels may be laminated in any of the Standard options seen on page 30.
- Widths 15" (38.1 cm), 18" (46 cm), 24" (61 cm), 30" (81 cm)
- Mounts on wall approx. 6" (15 cm) off floor, allowing for sweeping, mopping and sanitization (bleaching) under lockers. Island configurations mount to floor on legs.
- Integrated bench means no need for floor-mounted benches or folding chairs, saving critical square feet of room space.
- All units feature a hinged seat to which you can add an optional strongbox for secure storage.

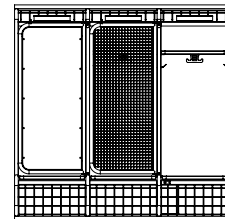

AIRPRO LOCKERS
Height: 70" (178 cm)
Widths: 15" (38.1 cm),
18" (46 cm),
24" (61 cm),
30" (81 cm)



Lockers with no doors include a hasp lock on hinged seat for a padlock.





HIGH-DENSITY STORAGE



Prosper High School, Prosper, Texas



“The GearBoss solutions have worked out great — choosing GearBoss was a fantastic decision. Our football equipment room is neat and organized. We also store equipment for other sports in GearBoss carts and GearBoss shelving — across eight rooms. When you look at the GearBoss system, you know right away it’s first-class.”

*- Kent Scott,
Athletic Coordinator and Head Football Coach
Prosper High School, Prosper, Texas*



Chanhassen High School,
Chanhassen, Minnesota

STORE MORE GEAR IN LESS SPACE.

GearBoss high-density storage lets you pack more gear into less space by utilizing an innovative system of tracks and rolling carts. Built to accommodate every imaginable type of sports equipment. The specially designed carts glide smoothly along a track, eliminating the need for space-consuming aisles. Without unnecessary walkways, you’ll gain as much as 50% more space for storage. It’s a system that will save you time, make inventory management easier and maintain the quality of your program. High-density storage has never been so high-tech.

HIGH-DENSITY STORAGE



X-CARTS™

(48" X-Cart shown)

MAXIMUM EFFICIENCY. MINIMUM HASSLE.

Randomly cramming tens of thousands of dollars of equipment into a room is hardly an efficient system. Now you can store all of your shoulder pads, helmets and gear simply and efficiently with X-Carts from GearBoss. Sliding along a fixed aluminum track, it's an efficient, flexible storage system that allows you to make the most of every inch of space.

DEDICATED STORAGE THAT'S READILY ACCESSIBLE

For sports that require permanent storage that needs to be readily accessible, move beyond bins and boxes to a high-density system that stores more in less space. When you need dedicated storage that maximizes cubic density without sacrificing accessibility, GearBoss X-Carts are the perfect solution because interior components can be easily moved or changed out to meet ever-changing programs.

IMPROVE AIRFLOW AND SANITATION

There are few things germs love more than a cramped, messy equipment room. Mold and mildew ruin gear faster than your biggest lineman. Bacteria and MRSA are threats that can have serious consequences. That's why GearBoss equipment is well-ventilated so your equipment stays clean and dry.

CONSULTATION AND LAYOUTS

The challenge of what to put where can be daunting. We're here to help. Our unique electronic layout tool and comprehensive equipment checklist will help determine the best solution for your specific athletic program. GearBoss equipment easily adapts to any environment, new construction or renovation project. Your GearBoss representative will work with you every step of the way – from room layout to installation. And when your needs change, we'll be there to reconfigure or upgrade your GearBoss system. Now that's support.

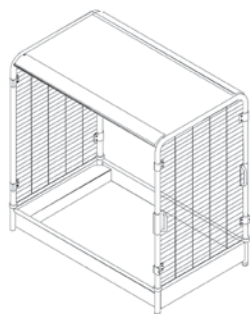

48" (122 cm) X-CART
On-rail only
Cart features lateral casters
79" H (201 cm)
48" W (122 cm)
78" L (198 cm)
334.88 lbs (152 kg)

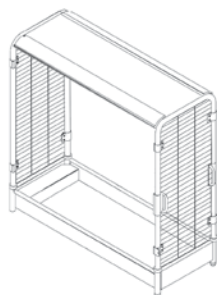

32" (81 cm) X-CART
On-rail only
Cart features lateral casters
79" H (201 cm)
32" W (81 cm)
78" L (198 cm)
250 lbs (114 kg)

HIGH-DENSITY STORAGE - X-CARTS™





TEAM CARTS™

(32" Team Cart shown)

STORAGE ON THE MOVE.

Now it's easy to get your equipment out of storage and to the gym, practice area, parking lot or sidelines – without breaking a sweat. GearBoss Team Carts retain all the convenient storage benefits of X-Carts but are engineered to leave the track. Imagine all your gear organized on one or two high-density storage carts, traveling effortlessly wherever it needs to go – and back again. Or park and lock your equipment in a temporary space, instantly creating safe, secure storage anywhere.

CONTROL INVENTORY

There's never been a better way to organize your equipment and keep track of inventory. When everything is in its place, managing inventory happens at a glance. A quick scan will tell you what's in its place and what's missing or what needs cleaning, repairing or replacing. Simple as that. GearBoss Sports Storage Systems take away the guesswork. You're in control, 100 percent of the time.

FLEXIBILITY WHILE YOU ORGANIZE

Configure any cart with a full range of panels, doors and grilles in your team colors, as well as add accessories like helmet hangers, shoulder pad stackers and more. See pages 30-35.

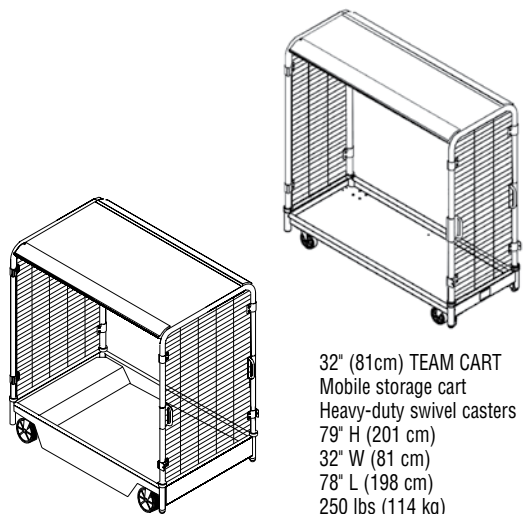

48" (121 cm) TEAM CART
Mobile storage cart
Heavy-duty swivel casters
79" H (201 cm)
48" W (121 cm)
78" L (198 cm)
250 lbs (114 kg)

32" (81cm) TEAM CART
Mobile storage cart
Heavy-duty swivel casters
79" H (201 cm)
32" W (81 cm)
78" L (198 cm)
250 lbs (114 kg)



Lakeville North High School,
Lakeville, Minnesota



Timber Creek High School, Keller, Texas



Chanhassen High School, Chanhassen, Minnesota

HIGH-DENSITY STORAGE - TEAM CARTS™



GEARBOSS
by Wenger®



SPORTCART™

SMALLER, MOBILE, BUT TOUGH AS NAILS.

Compact GearBoss SportCarts can be used as part of a larger GearBoss installation or as a mobile, stand-alone solution. They are designed for use in smaller spaces and for sports that require less storage. Four heavy-duty, 5" swivel casters make mobility a snap. The nimble SportCart will navigate narrow hallways, shorter door openings and most elevators. It's the ultimate small-space storage solution.



SportCart's smaller size may be a better option for sports with less equipment needs like volleyball, tennis, cross country, wrestling, etc.



*Northridge High School,
Middlebury, Indiana*



"We use a GearBoss equipment cart for our concessions and it's been very effective for us. We can wheel the candy out and it's all right there on shelves. When we're done, we can wheel it back into storage and lock it up. Taking inventory is quick because everything is visible on the shelves."

*- Dave Harms, Athletic Director
Northridge High School, Middlebury, Indiana*



*Owatonna High School,
Owatonna, Minnesota*

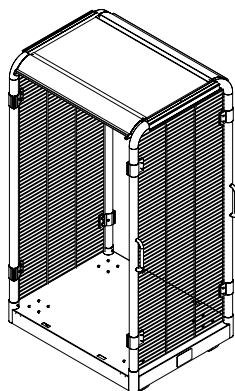

SPORTCART
6'1" H (185 cm)
32" W (81 cm)
42" L (107 cm)



Great for athletic trainers



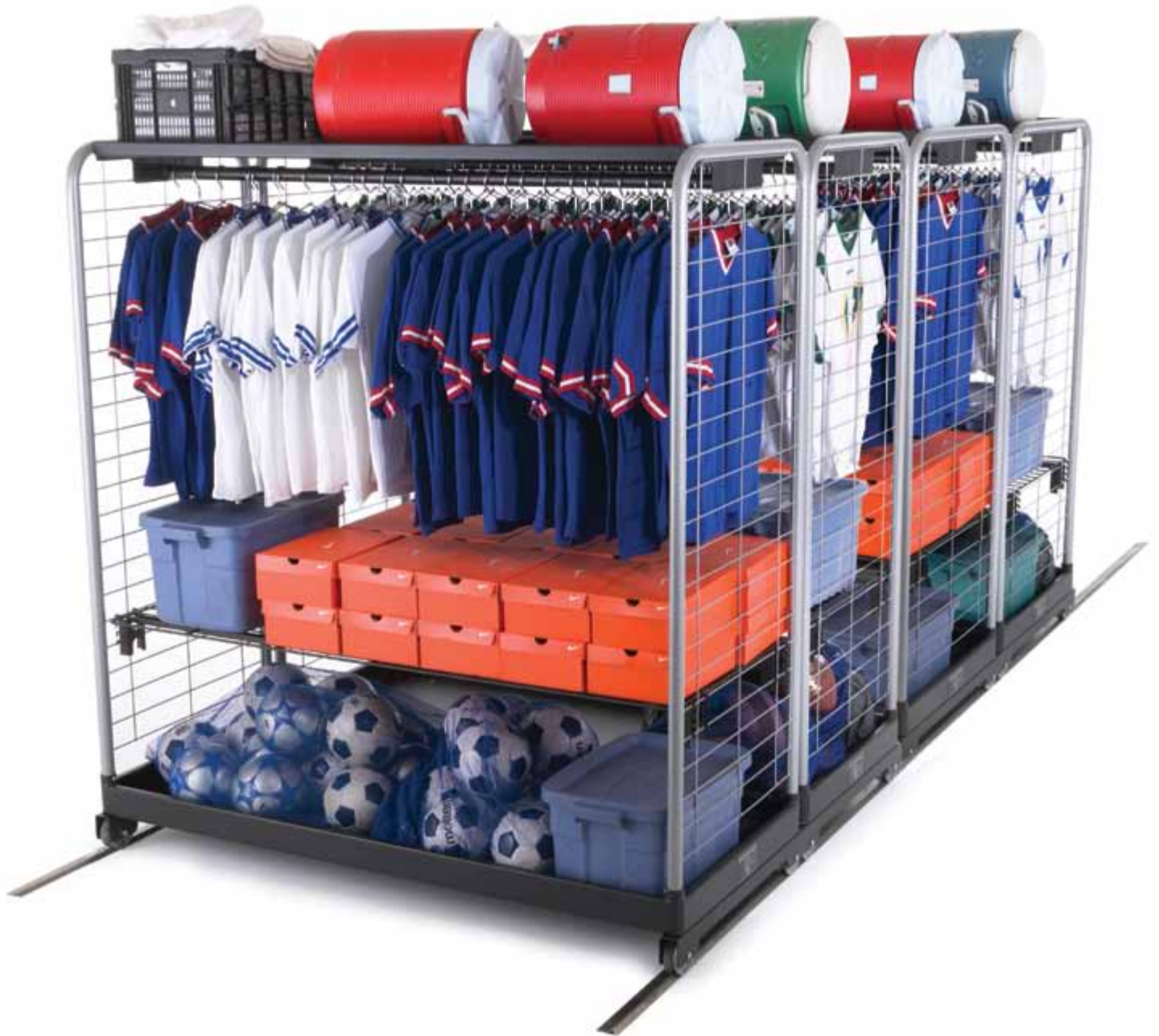

GEARBOSS® II High-Density Storage

GearBoss® II High-Density Storage

The newest high-density storage system from Wenger joins our successful Team and X-Carts in creating athletic equipment storage rooms that make better use of available space. With this new system you get the same space-saving organization as our existing carts in a simplified system with a budget-friendly price. You will gain more control over the time and money lost to poor organization, lax security and misplaced inventory.



Moving the storage system is easy – even when fully loaded – thanks to the smooth cast iron wheels and track.



Helmets and pads don't need to be thrown in a bin or on makeshift racks. GearBoss has accessories that keep your equipment orderly and let it breathe.



Hanger bars can be added with ease – now your jerseys can be orderly, fresh and wrinkle-free. Depending on spacing, one cart can accommodate between 290 and 360 hung jerseys. Load up the tops of the rack as well.



Grille Side Closure Panel
For added security in unlocked storage rooms



Floor Lock
A locking pin can keep GearBoss II carts from rolling — preventing access.



Track Stop
Keep carts from rolling off the end of your track.

Racks butt up against each other without pinching fingers, then roll back apart with ease.



CART PLACEMENT EXAMPLE:
Fill one end of a storage room wall-to-wall

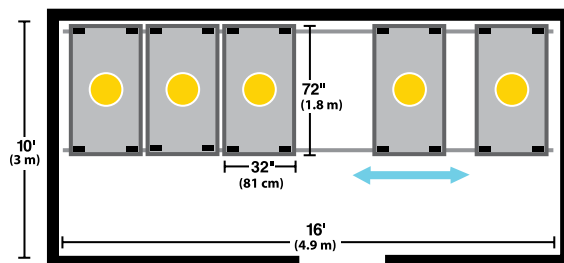

GEARBOSS II

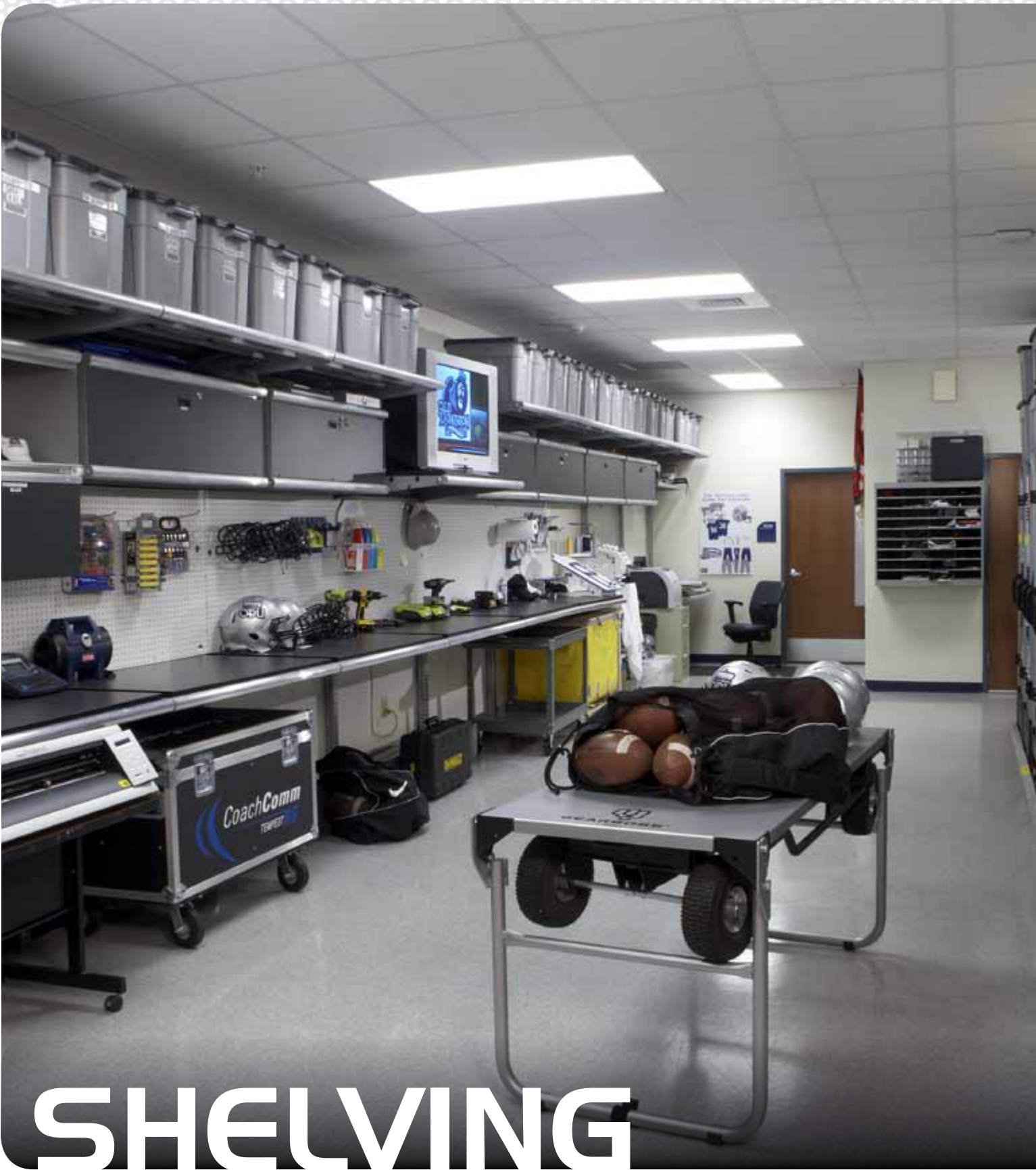

SHELVING



Old Dominion University, Norfolk, Virginia



"I believe our GearBoss system will save our high school money in the long run because of better organization, security and mobility."

*- Marty Udy, Athletic Director
Lower Lake High School
Lower Lake, California*

ORGANIZED, EFFICIENT, FLEXIBLE.

GearBoss shelving will finally help you win the battle to protect your investment in equipment and keep your storage areas organized. The cantilever design optimizes overhead space, keeps the floor open and can be easily reconfigured as your seasons change, all without tools.

FEATURES:

- Adjustable without tools in 1" (2.5 cm) increments
- 4 ft. wide x 8 ft. high (122 cm) bays
- Each bay holds up to 1,000 lbs. (454 kg)
- Two shelf depth options – 17.5" (44.5 cm) and 30.5" (77.5 cm)
- Accessories include lock boxes, garment bars, work surfaces and drawers





“These shelves are a great addition to our GearBoss system. They have enabled me to store our entire football helmet inventory on one small closet.”

*- Brian Gordon, Director of Equipment,
North Dakota State University*

ADJUSTABLE SHELVING

FLEXIBLE, AFFORDABLE AND DURABLE

Introducing a brand-new shelving system designed to meet all of your needs. Now you can maximize previously unused spaces like closets, corners and open walls. Additional shelves, hanging bars and lock boxes can be added at any time. Work surfaces can be added to create repair benches, pass-through stations and even desks. The possibilities are endless. Plus, when used with GearBoss Team Carts, X-Carts and SportCarts it creates a storage area that maximizes space and improves organization.



Shown with SportCart



Prosper High School, Prosper, Texas

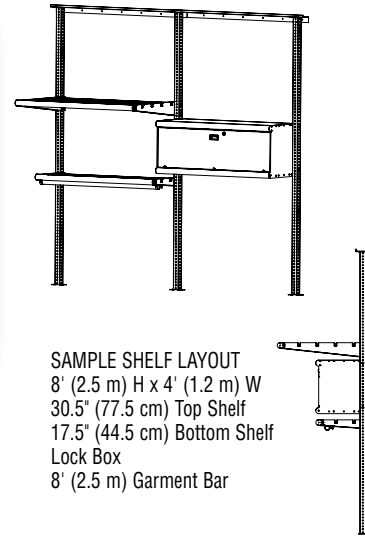

SAMPLE SHELF LAYOUT
 8' (2.5 m) H x 4' (1.2 m) W
 30.5" (77.5 cm) Top Shelf
 17.5" (44.5 cm) Bottom Shelf
 Lock Box
 8' (2.5 m) Garment Bar

USE YOUR SPACE CREATIVELY

GearBoss shelving can be sized to meet your needs, giving you the opportunity to create storage areas in unlikely places – including small areas of previously unused space. While stationary shelves are a perfect companion to GearBoss carts, they can also be used independently for a more economical storage solution.



Flexible height
shelves are adjustable in 1" (2.5 cm) increments without tools



Chanhassen High School, Chanhassen, Minnesota

Compact storage
Two 4' (122 cm) bays and twelve 30.5" (77 cm) shelves can store over 96 helmets



Adjust, fix, prep and planning work surface
Optional worktops are 5/8" (1.6 cm) laminated hardboard. They're perfect for workbenches or creating a desk. Height adjustable. Add a metal pull-out drawer for tools and more. Available with 30.5" (77 cm) deep shelves only. (Used under work surface only)



Shoulder the load
24 individually hung shoulder pads on six 30.5" shelves per bay offers maximum drying and shape retention



COLOR OPTIONS

The swatches shown below are standard wood laminate and grille colors for GearBoss carts and lockers. Additional laminate choices in your school colors are available. Contact your representative for availability, minimum quantities and a quote.



Doors and body can be individually colored



End closure kit for 32" (81 cm) and 48" (122 cm) width Team Carts, X-Carts & SportCarts



Side closure kit includes 3 fixed panels



Bypass door kit includes lockable panels

LAMINATES



GRAPHITE



EVENING TIGRIS



PEBBLE



OYSTER



CHERRY



SOLAR OAK



FUSION MAPLE

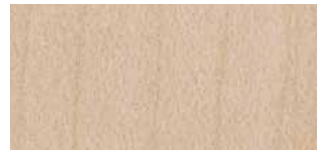

WENGER MAPLE

NOTE: Powder coat and laminates reflect light differently and do not always provide an exact match.

PAINTED GRILLES & LOCKERS



BLUE



NAVY



PURPLE



YELLOW



GOLD



ORANGE



RED



MAROON



GREEN



DARK GREEN



SILVER



WHITE



BLACK

Colors shown here are approximations. Actual colors may vary slightly. Ask your sales rep for an actual sample.



Team Cart shown with blue grille



AirPro locker with gold door and black frame and grilles

MAKE YOUR STORAGE SPACE WORK FOR YOU.



University of North Texas, Denton, Texas

CLOSURES AND DOORS

(Shown with attics and island stop option.)

Lockable bypass doors and panel closures enhance cart content security. Enclose the sides and ends of your carts with theft-resistant, 5/8" thick panels. Closures and doors can be finished with a variety of laminates and provide excellent space for team logos. Lockable sliding doors (32" and 42" carts only) and swing doors (SportCart only) are ready for your locks, adding another element of security.



University of New Mexico, Las Cruces, New Mexico

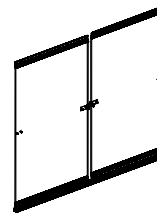

BYPASS DOORS
Easy-glide track and secured with a padlock.



32" (81 cm) END CLOSURE
Use with 32" (81 cm) cart



48" (122 cm) END CLOSURE
Use with 48" (122 cm) cart



SIDE CLOSURE
3 Panels leave small gaps to encourage air flow while deterring theft.

ACCESSORIES

CART CUSTOMIZATION



HELMET HANGERS

Hangers make it easier to access and move 8 helmets at a time. A 32" (81 cm) X-Cart can hold 56 helmets and a 48" (122 cm) X-Cart can hold 112 helmets on hangers.



SHELF LINER
Plastic liner used with shelf

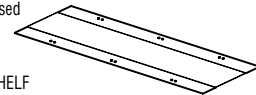

24" (61 cm) SHELF
Holds 150 lbs (68 kg)
10-11 helmets

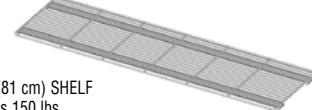

32" (81 cm) SHELF
Holds 150 lbs (68kg)
14 helmets

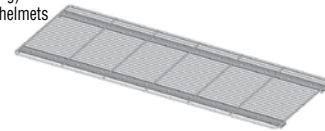

SHOULDER PAD HANGERS

Shoulder Pad Hangers come in two lengths and are best supported by our sturdy double truss. Hangers encourage better air flow around pads and easy access to any pad at any time.

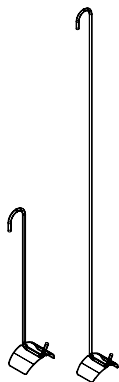

SHELVES

Heavy-duty steel wire shelves come in two convenient widths: 24" (61 cm) (used in a 48" wide cart) and 32" (81 cm) and shelves can be adjusted vertically in 1" (2.5 cm) increments. A plastic shelf liner accessory makes it easier to slide items in and out. Shelves offer adjustable storage for everything from water jugs to duffels, ball bags to bins. And don't forget about all those helmets. Sturdy, rugged and willing to take one for the team, each shelf can easily handle a 150 lb. (68 kg) load.

SHOULDER PAD STACKER

There simply isn't a better way to store lots of shoulder pads in less space. Made of durable steel tubing, each stacker can compactly store 18-22 pads. GearBoss Stackers feature four heavy-duty, built-in wheels to easily take the pads to the players. In addition, stackers feature an adjustable shoulder form so that pad shape is preserved while in storage.

With four stackers on a 32" (81 cm) cart, you will have over 70 pads stowed away yet ready to roll.

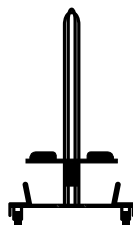

*Owatonna High School,
Owatonna, Minnesota*



GARMENT BAR AND DOUBLE TRUSS

One full-length garment bar can support over 150 jerseys. Made of powder-coated, 1½" (3.8 cm) sturdy steel tubing, garment bars stretch the length of the cart to accommodate hangers for uniforms, jackets, shoulder pads and more. And just like our shelves, they are vertically adjustable in 1" (2.5 cm) increments. The truss provides a little extra capacity and stops items from swinging.



FULL AND HALF LENGTH GARMENT BAR
For use in X-Cart, Team Cart and SportCart

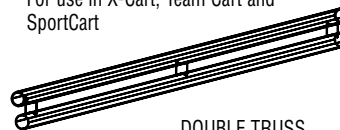

DOUBLE TRUSS
For use in X-Cart & Team Cart with helmet hangers and shoulder pad hangers



HANGING BRACKET

Securely attaches to wire grilles to support garment bars, shelves and more. Hanger Brackets easily detach if you need to reconfigure your cart for a new season or to support different accessories.



TRACKS

Tracks can be embedded in the floor for new construction or surface-mounted in existing facilities. Tracks keep the carts in line, allowing them to move laterally to provide access when and where you need it. (Surface-mounted track shown)

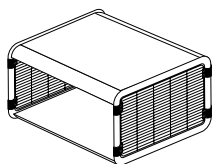

26" (66 cm) **SHORT ATTIC**
Fastens to a 48" (122 cm) X-Cart

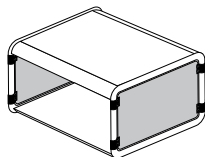

SHORT ATTIC END CLOSURE
Provides a clean look & team identity space. Use with short attic.



ATTIC EXTENSIONS

The GearBoss Storage Attic is engineered to maximize the vertical storage potential of your space. Storage Attic is 26" (66 cm) high to stretch the limits of your ceiling height. Storage Attics fasten securely to the frame of a 48" (122 cm) X-Cart to give your equipment room even more storage capacity. Attic colors can be matched to your cart system.

NOTE: Attic on 48" w cart only

CUBBIES

The GearBoss Team Cart and X-Cart can be easily configured and reconfigured just the way you want them. Simply position and reposition hangers, shelves and garment bars to fit your needs. Store helmets and shoulder pads during football season and bats, cleats and jerseys during baseball season. Shelf lips and cart dividers give you countless options for creating a cubby system that works specifically for you.



A PLACE FOR EVERYTHING

Load all your gear, from bags to water coolers, towels and more. With the GearBoss Cubby System you can divide and configure your carts in thousands of ways.

MULTI-PURPOSE DESIGN

The system is easily configured and quickly reconfigures as your needs change. Shelf lips keep loose items contained and all components are secured and adjusted without tools. The Cubby System makes hundreds of configurations possible, allowing you to size your storage compartments to fit your gear. Your storage space can't be more perfectly optimized.



SOFT CART DIVIDER

SOFT CART DIVIDERS

Mesh dividers allow you to divide a 48" (122 cm) wide GearBoss cart lengthwise. The mesh dividers allow visibility through the cart.



"The GearBoss systems are working great for us. They have really improved the organization and efficiency of our equipment room. Also, they bring a clean, stylish look with parts that are quick and easy to adjust to handle any changes we want to make to the system."

*- Chad Frazier, Football Coach
Heritage High School, Conyers, Georgia*



SHELF LIPS

Shelf lips secure with the same knobs as the dividers and can be set up with the tall side out for a 4" (10 cm) lip or the short side out for a 2.5" (6.3 cm) lip.



SHELF DIVIDERS

There are four dividers available in two depth and height combinations. They are adjustable side-to-side by loosening and tightening a simple thumb screw. To adjust the height, turn another knob and move to the desired dimension.

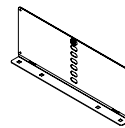

24" wide (61 cm) SHORT DIVIDER
Adjustable from 8" (20.32 cm) to 14" (36 cm) high

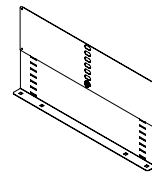

32" wide (81 cm) SHORT DIVIDER
Adjustable from 8" (20cm) to 14" (36 cm) high

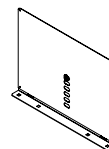

24" wide (61 cm) TALL DIVIDER
Adjustable from 15" (38 cm) to 20" (51 cm) high

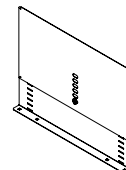

32" wide (81 cm) TALL DIVIDER
Adjustable from 15" (38 cm) to 20" (51 cm) high

P.E. APPLICATIONS

GearBoss is ideally designed to enhance your physical education curriculum and help create more rewarding experiences for everyone. And because the GearBoss system is so easy to use and adaptable to your needs, you'll quickly put it to work in a way that's best for your school.

You may store all P.E. equipment on X-Carts in your storage room and use Team Carts or SportCarts to load daily or weekly lessons – and then keep the carts locked in the gym as long as you need. You might store seldom-used phy ed equipment on X-Carts and keep active items ready to go on mobile carts. You could load your carts once a day or once a month, or change them up every week. You stop chasing gear once you have GearBoss, and that means more time and energy for class, and that is what it's all about.



"The Team Carts work out perfectly as mobile storage units. For P.E., we use one Team Cart to hold the ropes, helmets and other equipment for our climbing wall. Everything is conveniently stored inside the mobile cart, which is lockable so we can keep it secure."

*- Dave Harms, Athletic Director
Northridge High School,
Middlebury, Indiana*



Plan Ahead

GearBoss carts are high-density designs, so you can handle multiple lessons with a single cart. Sports gear you use infrequently throughout the year can be securely stored and ready for action at a moment's notice.

Improve Efficiencies

Pack the cart once and keep it locked in the gym, always ready for class throughout the duration of the lesson, be it a day, a week, or a month.

Save Time

You can load GearBoss carts with lots of equipment and keep them locked and ready to go wherever you need them next, anywhere inside the building or out.

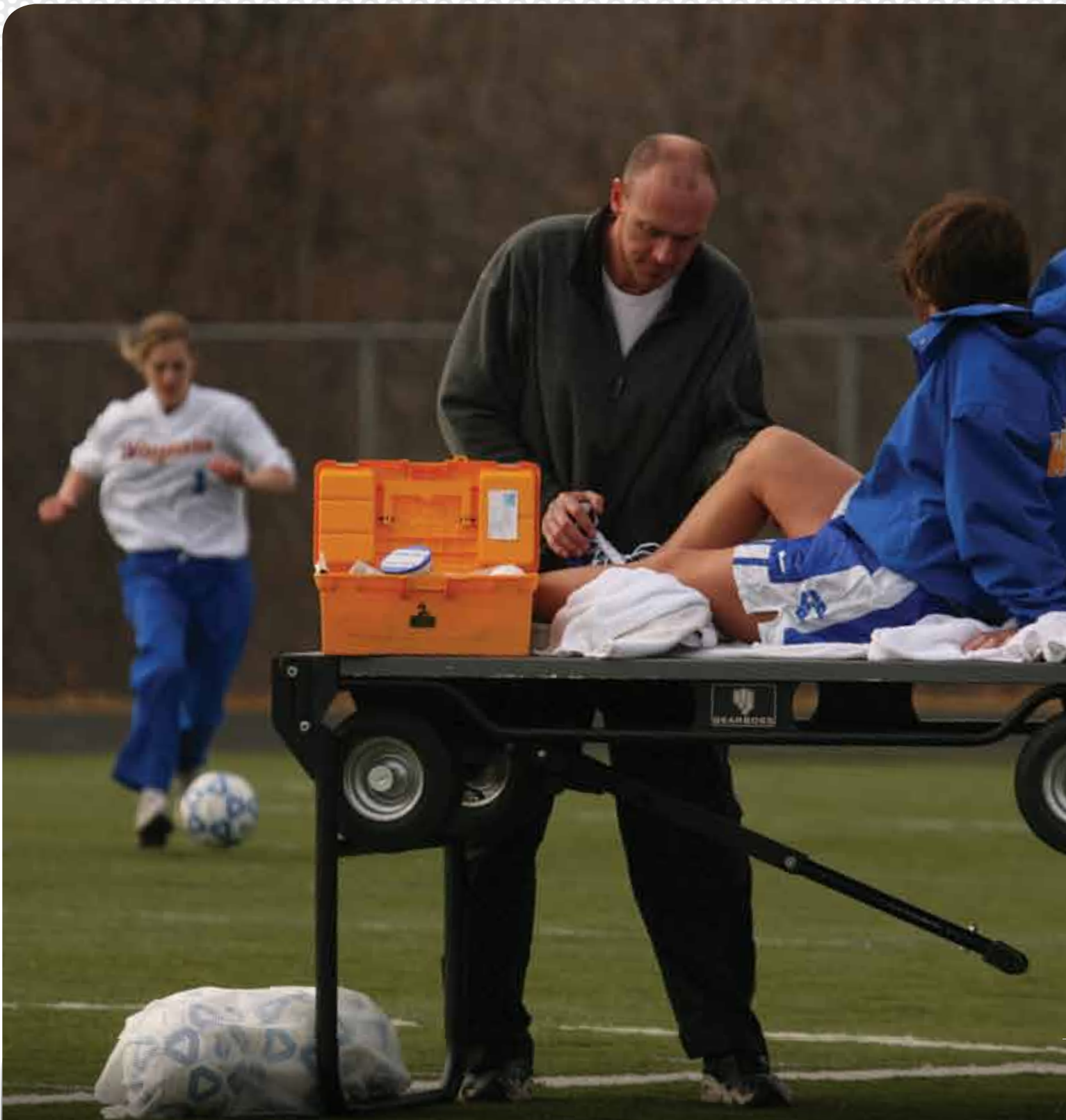

MOBILE SPECIALTIES



Wayzata High School, Plymouth, Minnesota



“Every time I turn around, my staff finds a new use for [the Transport Cart]. It fits all kinds of roles for us. Along with its primary use as a training table for evaluating players, it also works for repairing or restoring equipment, or just for holding water jugs and glasses.

*- Jaime Sherwood, Director of Athletics/Activities
Wayzata High School, Plymouth, Minnesota*

FOR PROGRAMS ON THE MOVE.

For an athletic program that’s always on the move, you need a storage system that’s just as active. GearBoss mobile carts and kiosks are built tough enough to withstand frequent use, yet nimble enough to go wherever you need them. Transporting your gear has never been easier.



MOBILE SPECIALTIES



TRANSPORT™ CART

MULTI-PURPOSE, ALL-TERRAIN CART AND TABLE

The extremely versatile GearBoss TranSport Cart is another clever innovation designed to meet the unique needs of school athletic programs. The TranSport Cart makes it easier than ever to move equipment through your facility and out to the field. And it's easily transformed into a sturdy table for use on the sidelines or anywhere else you need it.



"The GearBoss TranSport Cart we purchased last year has proven to be invaluable for all of our soccer and football programs, both to transport equipment as well as to serve as a trainer's table or scorer's table during games. We would be lost without it now!"

*- Dan Marlow, Athletic Director,
Bellows Free Academy, St. Albans, Vermont*



*Northridge High School,
Middlebury, Indiana*

TRANSPORT CART - TABLE
66" (168 cm) L x 30" (76 cm) W
x 32" (81 cm) H
Able to hold up to 1,000 lbs
(454 kg)

TRANSPORT CART -
MESH WRAP
Quickly snaps on
& off to hold items
inside cart



The GearBoss TranSport Cart offers heavy-duty construction for both configurations. Load it with gear to take to the field and quickly turn it into a table that easily holds up to 1,000 lbs. The cart itself weighs only 150 lbs. It's an equipment manager's best friend.



TRANSPORT CART
71.3" (181 cm) L x 31.5" (80 cm) W x 44" (112 cm) H
Cart Height 15.5" (39 cm) folded (shown on previous page) 150 lbs (68 kg)



ONBOARD[®] CARGO CART



RACK 'N ROLL[®]

A CART WITH ALL THE RIGHT MOVES.

The OnBoard® Cargo Cart garment rack is the perfect way to move heavy uniforms, coolers and duffels from place to place. It's easily maneuvered and is designed to roll through standard doorways or elevators. Load up all your game day gear onto one cart and bring it to the laundry facility and back again. The durable construction and powder coat finish ensure years of trouble-free use. The garment bar can be replaced with optional adjustable shelf.



"We looked at Wenger first because of their reputation, their quality and how they stand behind their products. I've always found Wenger equipment to be consistently good quality, durable and functional."

*- Dr. Joseph Scagnoli,
Associate Director, School
of Music, Ball State University,
Muncie, Indiana*

ONBOARD CARGO CART
72.5" (184 cm) L x 31.5" (80 cm) W x 70.5" (179 cm) H
Available with hard or pneumatic casters

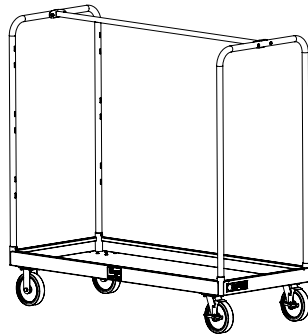

Solid rubber non-marring casters are extremely durable and provide smooth transport inside or outside your facility.



Take your equipment to where you practice and perform — pneumatic wheels make it easy for two people to transport carts loaded with heavy instruments whether on grass or concrete.

RACK IT UP, ROLL IT OUT.

The Rack 'N Roll garment rack is the perfect way to move heavy uniforms, coolers and duffels from place to place. It's easily maneuvered and is designed to roll through standard doorways or elevators. Load up all your game day gear onto one cart and bring it to the laundry facility and back again. The durable construction and powder-coat finish ensure years of trouble-free use.



Units completely set up and disassemble without tools, and stack up to 4 units high for compact storage. (2 units shown)

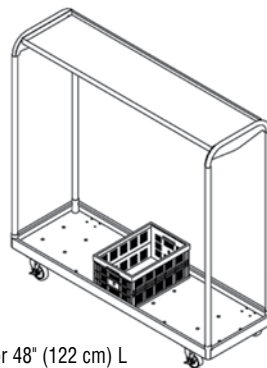

Rack 'N Roll
72" (183 cm) or 48" (122 cm) L
24" (61 cm) W
70.5" (179 cm) H



Handy prop boxes store odds and ends and keep them off the floor.



MOBILE SPECIALTIES - ONBOARD™ CARGO CART / Rack 'N Roll®





MOBILE KIOSK

TAKE FUNDRAISING TO A NEW LEVEL.

Logo gear has never traveled in such style. The GearBoss Mobile Kiosk is a self-contained mobile merchandising unit that goes where your fans go. Products stay neatly secured inside the kiosk while traveling from venue to venue. Panels open up to quickly display your merchandise.



Chanhassen High School, Chanhassen, Minnesota

FEATURES:

- 8 removable bins
- Pull handle acts as brake
- Lockable with one padlock
- Includes slot-wall display hardware
- Easy set-up anywhere in minutes
- Optional lighting & electric package (Does not meet international electric requirements)



MOBILE KIOSK - OPEN
119.5" (304 cm) H x 90" (229 cm) W
x 58" (147 cm) D, 550 lbs (250 kg)

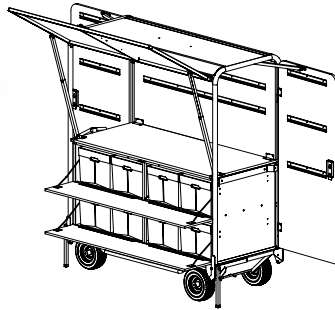

MOBILE KIOSK - CLOSED
77" (196 cm) H x 72" (183 cm) W
x 31" (79 cm) D, 550 lbs (250 kg)



"Just wanted you to know how awesome the Mobile Kiosk is! It was delivered at 11:00 and we took it straight to the gym. I threw some things on it for the back-to-school fair and we sold over \$2,000 in merchandise. We could have sold more but ran out of sizes! It was unbelievable; everyone was thrilled. Thanks for all your help!"

- Robin Schultz, All Saints Episcopal School, Tyler, Texas



HYDRATE® CART

During an outdoor event, the Hydrate Cart can come in real handy. It helps keep athletes hydrated and performing at their best while eliminating the need for unsanitary bottles and coolers. Plus, the Hydrate Cart maintains the same superior performance, durability and value as every other GearBoss product. It's also compact and easy to transport, so it goes where the action is.



HYDRATE CART
32" (81 cm) W x 42" (107) L
205 lbs (93 kg) - empty

FEATURES

- Aluminum frame with a 5-year warranty – virtually indestructible
- 50-gallon, (189 litres) FDA-approved tank and fixtures
- 8 drinking stations
- Large, sealed-bearing turf tires
- Quick-release, FDA-approved hoses and fixtures
- Bottom-draining valve



Environmentally Responsible
Reduce Waste



"I've looked at other water carts on the market and I think the Hydrate Cart tops them all. It's durable, handles well and is easy to move on grass, turf and gravel. The bubbler-type sprayer means kids don't waste water spraying each other. The large tank empties quickly and completely."

*- Frank Mastrangelo, Certified Athletic Trainer,
Dexter and Southfield Schools, Brookline, Massachusetts*



FIELD PODIUM



This podium is a mobile, easy-to-use viewing platform for coaches, judges, spirit squad leaders and camera operators. With a few simple adjustments, you can quickly move the podium from the field, to the court, to the stadium.



Owatonna High School, Owatonna, Minnesota

FEATURES

- Easy fold design allows two people to set it up in under a minute
- Includes two gas-assisted pistons for easy lifting
- Non-marring rubber wheels easily handle multiple surfaces
- Tow bar included for pulling by hand or behind a utility vehicle
- 46" x 60" (117 cm x 152 cm) deck size – will accommodate two people
- Folds flat for easy storage and transport in trailers or trucks



The Field Podium can set up easily in a few simple steps with two people.

PLAN BETTER, PERFORM BETTER.

Platinum Reversible Board

Elevate your game plan with durable Wenger Markerboards. Ideal for use in the locker room, they're made with a smooth, porcelain-clad surface that eliminates marker ghosting.

- 40" H x 30" W (102 cm x 76 cm) or 4' x 6' (122 cm x 183 cm)
- Anodized aluminum frame
- Rotating surface with wide base and 3" locking casters



*Environmentally Responsible
Contains No VOCs*



Tackboards

Available in either rubber or vinyl surfaces, Wenger Tackboards are an excellent message vehicle for any public area.

- Sizes: 1 1/2' x 2' (46 cm x 61 cm)
33 3/4" x 48" (86 cm x 122 cm)
4' x 12' (122 cm x 366 cm)
- Resists moisture, mold, mildew and chemicals
- Available in a wide range of colors
- Extruded-aluminum frame with anodized satin finish

Porcelain Steel Markerboard

Wenger Porcelain Steel Markerboards eliminate marker ghosting to ensure your board will last for years. Plus, the magnetic steel surface is laminated to a 7/16" MDF substrate for extra strength and moisture resistance.

- Sizes range from 33 3/4" x 48" (86 cm x 122 cm) to 4' x 16' (122 cm x 488 cm)
- Includes L-clips, rawl plugs, and screws for installation
- 50-year warranty

DuraSafe® Markerboard

If safety is an issue, this is the ideal marker board. With a porcelain steel surface and a soft silicone rubber tray, this durable, environmentally friendly surface offers the highest safety standards of any board available.

- Sizes range from 33 3/4" x 48" (86 cm x 122cm) to 4' x 12' (122 cm x 366 cm)
- 50-year warranty



MORE THAN 65 YEARS OF EXPERIENCE.

VERSALITE® STAGING

The flexible blocks you need to create and recreate multi-level seat riser structures for half-time show, bands and spectators.

- Full array of pies and tri-corners helps you configure a set that meets virtually any seated riser application
- Choice of 2-, 3- or 4-tier or larger sets
- Optional band/orchestra rear percussion extension



Portable ADA-compliant disability ramp

DID YOU KNOW...

Wenger offers a large choice of staging options. Please call your representative for info or ask for our full product catalog to see our entire line.

STRATA® STAGING

The ideal choice whether you're staging for an outdoor event or extending an indoor stage.

- Pre-attached substructure components make setup fast and intuitive
- Use of beams rather than bridging supports frees up open space below
- Decks fit together to create an integrated surface that is seamless and extremely quiet



STAGEMOBILE® MOBILE STAGE

A fully contained staging system that lets you stage events with ease anywhere on the road.

- All-aluminum construction resists the elements. Designed for long-term outdoor storage
- Easy one-person setup with gas-assisted pistons and built-in leveling jacks
- Optional skirting, guardrails and stairways also available



WENGER MAY ALREADY BE IN YOUR FACILITY.

Wenger Corporation is a trusted supplier to the education and performing arts markets. Your school or facility may already have Wenger on your list of approved vendors. GearBoss by Wenger can be purchased through those same Wenger purchasing contracts. Speak with your district's business office to find out if your school has current Wenger contracts you can access. You can also contact your GearBoss representative for more information.

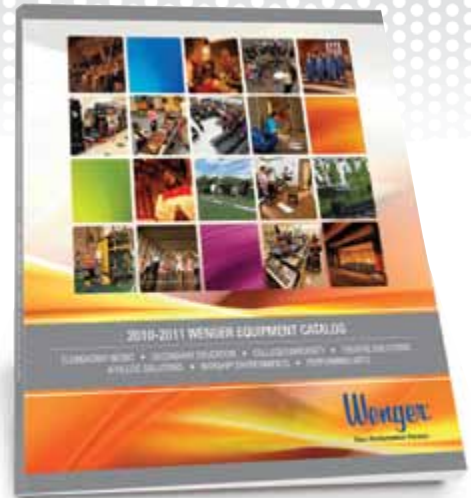

WENGER TERMS AND CONDITIONS

PRICING

Prices are subject to change without notice. Prices shown do not include shipping and handling. In cases where payment will be made using non-U.S. currency, request a current exchange rate. For more information, please contact your Wenger representative. Instruments and accessories shown with specific Wenger products throughout the catalog are not included in the price and they do not come with the purchase of the product.

SHIPPING POLICY

Prices shown do not include shipping and handling charges because we do not use a flat rate. In order to provide you the most favorable rate we calculate the cost of each shipment individually based on size and weight. Your Wenger representative is ready to provide you with a full quote, including shipping and handling based on your location and the weight of your order. All weights listed in our catalog are product weights and not shipping weights. For exact shipping and handling charges, please ask your Wenger representative.

DELIVERY AND INSTALLATION

Wenger delivery and installation services are two great advantages of buying direct from Wenger. At your option, we will package, ship, and install your order with the care and understanding that only the product manufacturer can provide. Wenger drivers and installers are experienced professionals who are intent on meeting your needs and providing the service you expect. Wenger installation services will ensure that your Wenger investment is in perfect working order from day one and for many years of performance. Please contact your Wenger representative for exact costs for these services.

CHANGES/CANCELLATIONS

Any changes or cancellations to orders for standard product require written consent from Wenger. A 25% fee may apply if changes or cancellations occur within 15 days of shipment. Changes and/or cancellations to custom products including Customer's Own Material (COM), finish matches, custom colors, rush orders, or modified products are not allowed.

DELAYS/STORAGE

Two weeks advance notice is required when any delays in shipment, delivery, or installation beyond the acknowledged ship date are necessary. The costs of storage, rehandling, additional freight, and additional installation or labor costs will be billed to the Purchaser. If goods require storage, transfer to storage will be deemed as shipment to the Purchaser for all purposes including invoicing and payment.

RETURNS

Returns are not accepted without written approval from Wenger. All authorized returns are subject to a minimum 20% restocking/rehandling fee which may be higher depending upon the product. Custom products are not returnable.

CUSTOMER SERVICE

If you have questions about your Wenger product or have any problems with your order, please call our Customer Service representatives at 1-800-887-7145.

WARRANTY

Wenger products are guaranteed to be free of defects in materials and workmanship for a period as described in the Wenger Warranty statement. For complete warranty information, please contact the Wenger customer service department at **1-800-4WENGER (493-6437)** or visit our website at www.wengercorp.com.



University of Missouri, Columbia, Missouri



Germantown High School, Germantown, Wisconsin



College of William and Mary, Williamsburg, Virginia



GEARBOSS[®]
by *Wenger*[®]

OUR PROMISE

Your complete satisfaction is very important to us. That's why we use only the most durable materials and a quality-controlled manufacturing process that is second to none. All GearBoss[®] Athletic Products are guaranteed free of defects in materials and workmanship for five years and ten years on all weldments. Our guarantee assures you either a full refund, repair or replacement of the defective materials or workmanship without charge. If you are dissatisfied in any way with a GearBoss product, simply call a Wenger customer service representative and the problem will be resolved.

For 65 years, Wenger Corporation has been designing and manufacturing specialized storage solutions for schools, colleges, universities and private industry. Based in Owatonna, Minnesota, Wenger is renowned for providing the highest quality products and design consultation for existing facilities and new construction projects. Offering the best service and support in the industry, Wenger maintains strict quality controls and has been awarded ISO 9001/2000 designation. For information about any of Wenger's products or services, contact your area representative at: 1-800-4WENGER (493-6437) or visit www.wengercorp.com.

United States

Wenger Corporation
555 Park Drive P.O. Box 448
Owatonna, MN 55060-0448
Phone: 1-800-4WENGER (493-6437)
Fax: 507-455-4258
Customer Service: 800-887-7145
www.wengercorp.com

Canada

Phone: 800-268-0148
www.wengercorp.com

Worldwide

Phone: 1-507-455-4100
Fax: 1-507-444-0685

US/9-10/25M/LT0182E

