



511 SOUTH 7TH STREET
DELANO MN 55328
Phone: 763.972.2981
Fax: 763.972.2911

www.industriallouvers.com
ilinfo@industriallouvers.com

MODEL 650XPI

STANDARD CONSTRUCTION

Blades to be .081" extruded aluminum 6063 mounted on 5" x 2" x 1/8" aluminum support channels.

Finish to be mill.

INSTALLATION

Model 650XPI should be installed in accordance with manufacturers recommended attachment method and in accordance with state and federal building codes.

WARRANTY

All materials and workmanship are warranted for a period of 1 year from date of completion.

MAINTENANCE

None required.

FEATURES

- All sizes are custom fabricated to meet project requirements.
- Clip angles for installation.

OPTIONAL ACCESSORIES

Many optional accessories to the basic design are available at an additional cost. They include:

- Hinged access panels.
- Cap flashing at head.
- Visible or invisible mullions for multiple section requirements.
- Anodized or Kynar finish

Please contact the factory for other special requirements.

SUGGESTED SPECIFICATIONS

Furnish and install where indicated on the drawings ILI equipment screen Model 650-XPI inverted blade screen as manufactured by Industrial Louvers, Inc., Delano, MN. Inverted blades shall be fabricated from .081" extruded aluminum. Vertical supports shall consist of 5" x 2" x 1/8" aluminum channels at a maximum of 60" o.c.

CATALOG NO. 650XPI

Rev: AUG. 2010

MODEL 650XPI

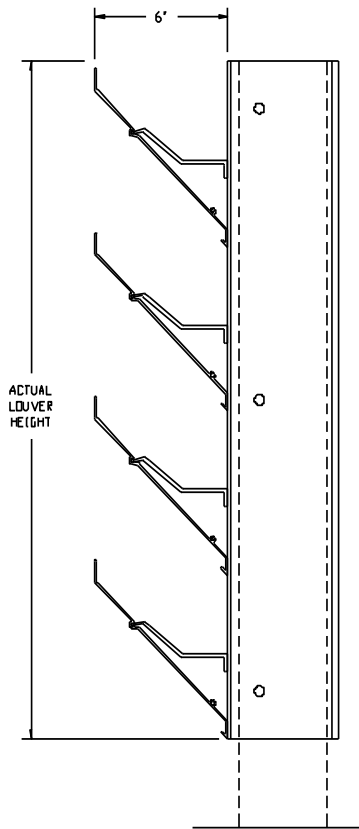

VERTICAL SECTION

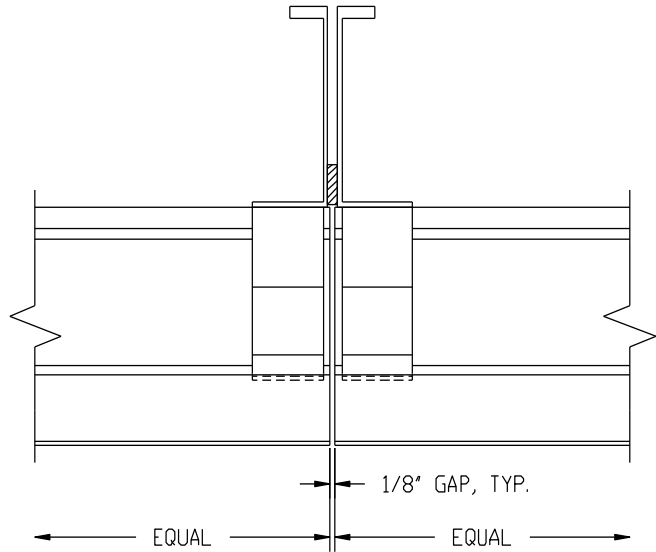

INVISIBLE MULLION DETAIL

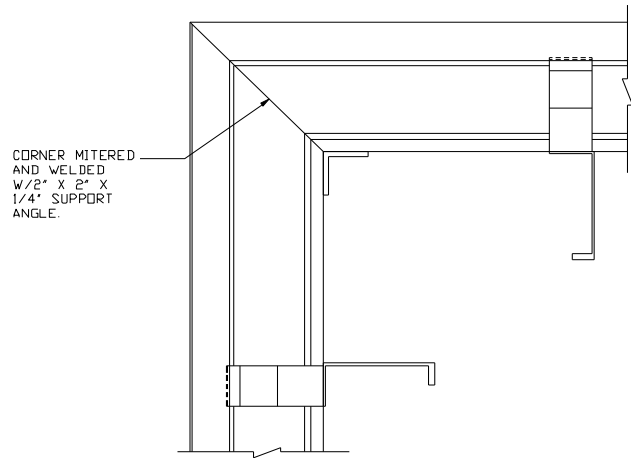

TYPICAL MITERED CORNER SECTION

ACCESSORIES:

- FINISH _____
- COLOR _____
- OTHER _____

ITEM NO.	QTY	SIZE		Actual <input type="checkbox"/>	M.O. <input type="checkbox"/>	MULLION TYPE	NO. OF SECTIONS	REMARKS
		WIDTH	HEIGHT					

PROJECT _____	REPRESENTATIVE _____
LOCATION _____	ILI JOB NO. _____ REP NO. _____
ARCH/ENGR. _____	Industrial Louvers, Inc. Phone: 763-972-2981
CONTRACTOR _____	511 South 7th Street Fax: 763-972-2911
DATE _____	Delano, MN 55328
CATALOG NO. 650XPI Rev: AUG. 2010	