

THE NEXT GENERATION OF WALLS®

FROM THE
CREATORS OF **AdvanTech**

ZIP System® Wall Sheathing INSTALLATION MANUAL

Sales Office: 10925 David Taylor Dr., Suite 300 Phone: 800-933-9220 zipsystem.com
Charlotte, NC 28262 Fax: 704-547-9228

©2008 Huber Engineered Woods LLC. AdvanTech and The Next Generation of Walls are registered trademarks of Huber Engineered Woods LLC. ZIP System, the accompanying ZIP System logo and design and Stormex are trademarks of Huber Engineered Woods LLC. Huber is a registered trademark of J.M. Huber Corporation. HUB313-12/10

another innovation from



ZIP System® Wall Sheathing INSTALLATION MANUAL



THE NEXT GENERATION OF WALLS®

Contents

02	ZIP System® Wall Sheathing Installation	06	ZIP System® Wall Sheathing - Penetration Openings
03	ZIP System™ Tape Installation - Panel Seams	07	ZIP System® Wall Sheathing Installation Details
04	ZIP System® Wall Sheathing - Window Installation Flanged Windows & Brick Mould Windows	08	ZIP System® Wall Sheathing Installation Details (continued)
05	ZIP System® Wall Sheathing - Window Installation Brick Mould Windows (continued)		

ATTENTION: This installation guide is intended to provide general information for the designer and end user. The following guidelines will help you safely and properly install the ZIP System® wall sheathing. We urge you, and anyone installing this product, to read these guidelines in order to minimize any risk of safety hazards and to prevent voiding any applicable warranties. This manual is a general installation guide and does not cover every installation condition. Proper installation shall be deemed to mean the most restrictive requirement specified by Huber Engineered Woods (HEW), local building code provision, the model building code adopted by the local jurisdiction, the government agency having jurisdiction or the engineer or architect of record. You acknowledge that it is solely your obligation for all safety requirements and code compliance. For additional information contact Huber Engineered Woods LLC.

ZIP System® Wall Sheathing Safety Guidelines

- Follow all OSHA regulations and any other safety guidelines and safety practices.
- Use approved safety belts and/or harnesses or other fall protection equipment.
- Install ZIP System panels and tape only in dry conditions and on dry surfaces. Do not install in rain, snow, frost or other slippery conditions.

What Is ZIP System® Wall Sheathing?

ZIP System wall sheathing is an innovative system that can be used as a combination wall sheathing, water-resistive barrier and air barrier. ZIP System wall sheathing has a built-in water-resistive barrier that lets you say good-bye to housewrap forever. Simply install the panels, tape the seams, and you have a structural wall sheathing, water-resistive barrier and air barrier all-in-one.

ZIP System wall sheathing can be used with a range of exterior claddings including brick, vinyl, stone, wood fiber cement, wood and cedar shakes, traditional hard coat stucco and specified drainable EIFS applications, however it is not recommended for use with adhesively attached EIFS. Follow all cladding manufacturer's installation instructions.

ZIP System wall sheathing can be used on buildings of type V construction and construction permitted under the IRC.

ZIP System® Wall Sheathing Includes:

- ZIP System wall sheathing panels with built-in Stormex™ water-resistive barrier with preprinted fastening and tape guides
- ZIP System tape

Storage and Handling

- Set panel stack on three supports (stickers) to keep off the ground.
- Outdoors, cover panels loosely with waterproof protective material.
- Anchor covers on top of the stack, but keep away from sides and bottom to assure good air circulation.

- In high moisture environments, cut banding on the panel stack to prevent edge damage.

ZIP System® Wall Sheathing Notes and Limitations:

- Do not use on roofs
- Do not use abutted against general stone or masonry without providing a minimum of a 1/2" gap
- Do not install ZIP System tape in temperatures less than 20° F
- ZIP System products are not recommended for manufactured housing applications that are built under a federal building code administered by the U.S. Department of Housing and Urban Development (HUD).
- Do not use in Structural Insulated Panels (SIPs).

Wall Coverings

- ZIP System wall sheathing should be covered with exterior cladding within 180 days of installation.
- Exterior cladding products should be installed per the manufacturer's installation instructions.
- Per the recommendation of the Western Red Cedar Lumber Association and the U.S. Forest Products Laboratory, wood siding should be primed before installation.
- When original claddings are removed and replaced on an existing ZIP System wall sheathing assembly, the wall should be covered with a secondary water resistive barrier prior to installation of the new cladding.
- Cuando se quiten y sustituyen los revestimientos originales en un ensamblaje ZIP System ya existente, deberá cubrir la pared con una barrera secundaria resistente al agua antes de instalar el nuevo revestimiento.

Note: In cladding systems requiring multiple layers of water-resistive barriers, like traditional hard-coat stucco, ZIP System wall sheathing is intended only to replace the first layer.

Wet Blown Cellulose Insulation

- In addition to following manufacturer installation instructions, we recommend a maximum moisture content of the cellulose of less than 25% measured at the inside surface of the ZIP System panel before closing the wall cavity.

Secondary Coatings

- Do not apply secondary coatings or treatments to ZIP System wall sheathing panels with the exception of HEW-approved fire resistant coatings and field-applied water-soluble borate insecticide or fungicide treatments applied to the non-overlay side of the panel. See technical tip, "Termite Treatments on ZIP System Wall and Roof Sheathing," on zipsystem.com for more information. Fire resistant coatings must be tested and approved by HEW for use with ZIP System panels.

02

ZIP System® Wall Sheathing Installation

Overview: ZIP System wall sheathing is composed of ZIP System wall sheathing panels and ZIP System seam sealing tape. ZIP System® Wall Sheathing panels should be fully installed before the seam sealing tape is applied. The following installation steps are presented as a general outline of the installation process. These are manufacturer installation recommendations – please visit zipsystem.com for a library of flashing and installation details. You are fully and solely responsible for all safety requirements. Good construction and safety practices should be followed at all times.

Step 1. Install ZIP System wall sheathing panels positioned with the water-resistive barrier facing outside. The panels may be installed with the long side of the panel oriented either horizontally or vertically to the framing members. Walls that are designed to resist lateral shear forces and sheathed with wood structural panels typically require solid framing or blocking behind all panel edges. If oriented horizontally, block horizontal joints if wall is designed for bracing or as a shear wall.

1/8" spacing between square edges of all adjacent panels is recommended in accordance with industry standards for wood sheathing installation.

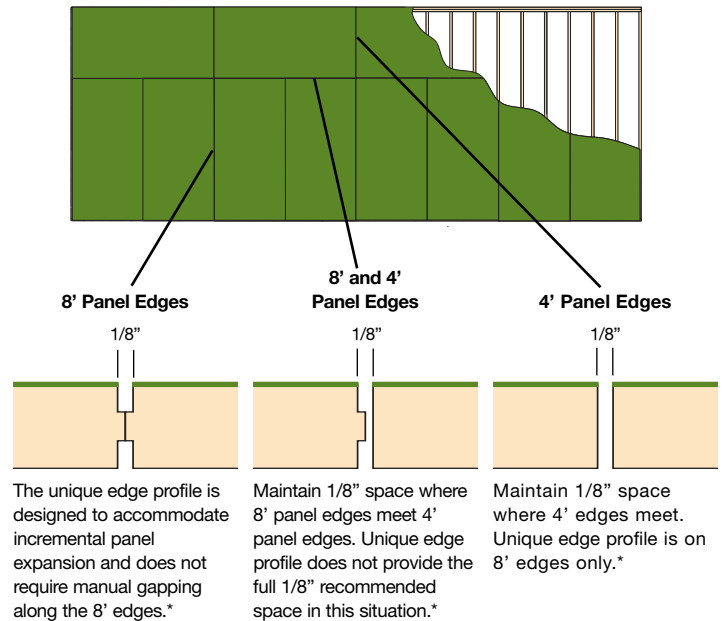

Step 2. Fasten the panels to the framing members with code approved fasteners. Space fasteners 6" o.c. along supported edges and 12" o.c. at intermediate supports, unless otherwise specified by local code or the designer of record. It is the responsibility of the general contractor to verify proper fastener type and spacing prior to installation. Apply the fasteners 3/8" from the ends and corners. An ideal installation would be where fastener heads are flush with the panel surface. However, due to variations in materials and limitations on equipment, this may be difficult to achieve in some situations. It is not required to tape over overdriven fasteners unless the fastener head creates a hole through the entire panel thickness. Please see the technical tip "Overdriven Fasteners in Zip System Roof and Wall Sheathing," on zipsystem.com for more information.

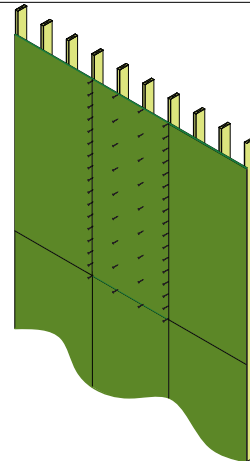

ZIP System Tape™ Installation - Panel Seams

Apply ZIP System tape after all ZIP System wall sheathing panels are fully fastened to wall-framing members. Only ZIP System tape should be used to seal the seams of ZIP System panels. Ensure that the panel surface is dry and free of sawdust and dirt prior to taping. **ZIP System tape is a contact tape that requires pressure for an adequate seal.**

Step 1. Tape all seams using ZIP System tape. Ensure that the tape is centered over the seam within $\pm 1/2$ " to provide adequate coverage and that wrinkles in tape are minimal.

Use the ZIP System tape gun or roller to apply pressure to the tape and smooth out any wrinkles.



Step 2. Wherever tape splices occur at a horizontal or vertical seam, create an overlapping splice of at least 3".

At T-joints, the tape pieces should overlap by at least 1". Apply moderate pressure onto the surface of the tape to ensure a secure bond between the panel and the tape.

Use the ZIP System tape gun or roller to apply pressure to the tape and smooth out any wrinkles.

Take special care to remove any voids and/or trapped air at splice areas and T-joints.

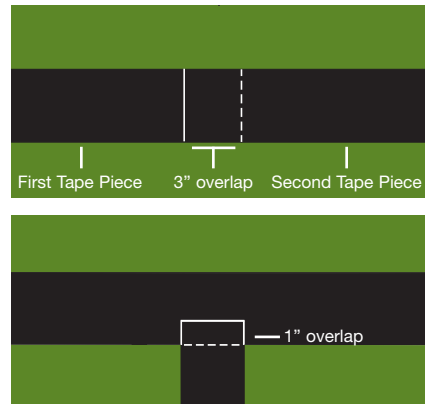

Step 3. Tape inside and outside corner seams.

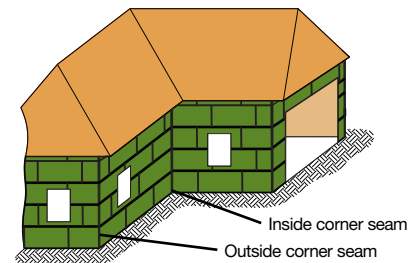

Note: Tape over any areas of the panel or tape that are damaged during construction.

04

ZIP System - Window Installation

DISCLAIMER: The following steps represent a general overview for the proper installation of window flashing. Please defer to/consult the installation instructions of your window manufacturer as well as code requirements in your jurisdiction for full installation details.

Flanged Windows

1. Fasten the ZIP System wall sheathing sheathing to the wood frame and install ZIP System tape to all wall panel seams, as de-tailed in sections 02 and 03.

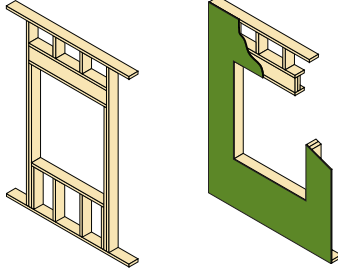

5. Cut a length of ZIP System tape or another adhesive-backed flashing tape (must meet ICC-ES Acceptance Criteria for Flashing Materials (AC148)) and apply to the header, ensuring that the flashing overlaps the jamb flashings.*

Once the tape is in place, use the tape gun or roller to seal the flashing to the sheathing.

*DO NOT tape bottom flange.

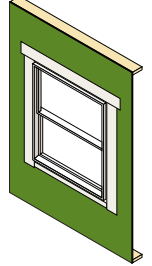

2. ZIP System tape may be used as pan flashing if installed in accordance with flanged window installation details posted on zipsystem.com. Other adhesive-based flashing tapes (must meet ICC-ES Acceptance Criteria for Flashing Materials (AC148)) may be used as pan flashing if installed per ASTM 2112-07. Apply the flashing to cover the bottom of the opening, overhanging onto the sheathing by at least 2" and extending a minimum of 6" up each jamb.

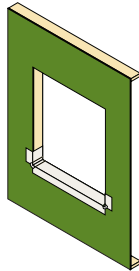

6. From the interior, apply low-pressure polyurethane foam (for windows) between the rough opening and the window frame. (Caulk sealant compatible with the sill flashing may be used at the sill if the opening between the sill flashing and window is too narrow to allow the use of low-pressure polyurethane foam.)

When using ZIP System tape, butyl, silicone or polyurethane sealants are acceptable. Do not use latex sealants with ZIP System tape. If using another flashing tape, follow the flashing manufacturer's recommendation in selecting a sealant compatible with that flashing.

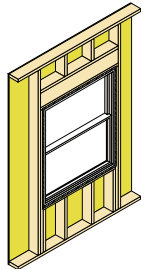

3. Apply sealant around inside face of mounting flange. Sealant must be gapped at the sill to permit drainage. Install and level window per manufacturer's installation instructions. Verify sealant compatibility with window manufacturer. When using ZIP System tape as pan flashing, butyl, silicone or polyurethane sealants are acceptable. Do not use latex sealants.

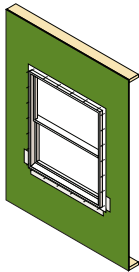

Brick Mould Windows

1. Fasten the ZIP System wall sheathing sheathing to the wood frame and install ZIP System tape to all wall panel seams, as de-tailed in sections 02 and 03.

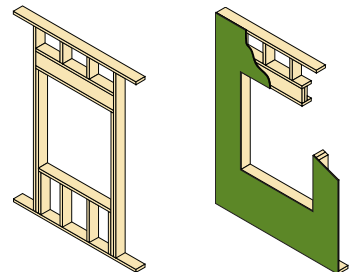

4. Cut two pieces of ZIP System tape or another adhesive-backed flashing tape (must meet ICC-ES Acceptance Criteria for Flashing Materials (AC148)) and apply to each of the window jamb flanges, ensuring the jamb flashings overlap the sill flashing.

Once the tape is in place, use the tape gun or roller to seal the flashing to the sheathing.

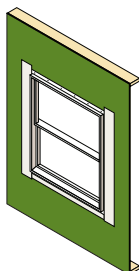

2. If recommended by the window manufacturer, cut a strip of wood to function as a back dam at the sill. The wood strip should have a length equal to the width of the rough opening and a height and width of at least 1/2". Position the block at the inside edge of the window frame.

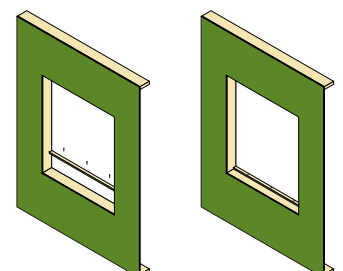

ZIP System - Window Installation

DISCLAIMER: The following steps represent a general overview for the proper installation of window flashing. Please defer to/consult the installation instructions of your window manufacturer as well as code requirements in your jurisdiction for full installation details.

Brick Mould Windows (continued)

3. ZIP System tape may be used as pan flashing if installed in accordance with brick mould window installation details posted on zipsystem.com. Other adhesive-based flashing tapes (must meet ICC-ES Acceptance Criteria for Flashing Materials (AC148)) may be used as pan flashing if installed per ASTM 2112-07. Apply the flashing to cover the bottom of the opening, overhanging onto the sheathing by at least 2" and extending a minimum of 6" up each jamb.

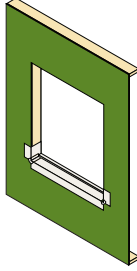

7. Cut a piece of rigid head flashing so that when installed, it is flush with the edges of the exterior moulding of the window. Apply a bead of sealant to the back and bottom surface of the rigid head flashing. Use sealant recommended by the flashing manufacturer.

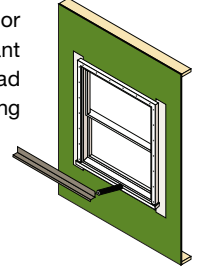

8. Secure the rigid head flashing to ZIP System wall sheathing.

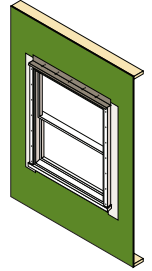

4. For vertical jambs, cut ZIP System tape or another adhesive-backed flashing tape (must meet ICC-ES Acceptance Criteria for Flashing Materials (AC148)) and apply to each of the window jambs. Ensure that they cover the entire inside of the rough opening as well as overlap onto the sheathing by at least 2". Flashing shall also extend above the rough opening, such that it will project 1" beyond the exterior trim of the window.

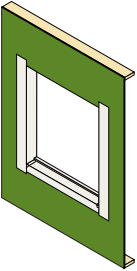

Once the tape is in place, use the tape gun or roller to seal the flashing to the sheathing.

9. Cut a length of ZIP System tape or another adhesive-backed flashing tape (must meet ICC-ES Acceptance Criteria for Flashing Materials (AC148)) and apply to the rigid head flashing, ensuring that the adhesive-backed flashing overlaps the jamb flashings.

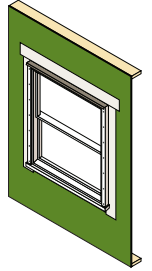

Once the tape is in place, use the tape gun or roller to seal the flashing to the sheathing.

5. Apply sealant to jambs and header allowing for drainage at the sill in accordance with window manufacturer's installation instructions. When using ZIP System tape, use a butyl, polyurethane or silicone sealant. Do not use latex sealants with ZIP System tape. When using another flashing tape, follow the flashing manufacturer's recommendations in selecting a sealant compatible with that flashing.

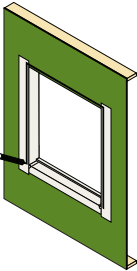

10. From the interior, apply low-pressure polyurethane foam (for windows) between the rough opening and the window frame. (Caulk sealant compatible with the sill flashing may be used at the sill if the opening between the sill flashing and window is too narrow to allow the use of low-pressure polyurethane foam.)

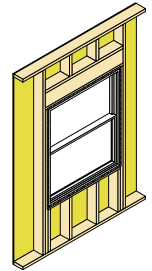

When using ZIP System tape, butyl, silicone or polyurethane sealants are acceptable. Do not use latex sealants with ZIP System tape. If using another flashing tape, follow the flashing manufacturer's recommendation in selecting a sealant compatible with that flashing.

6. Install and level window per manufacturer's installation instructions.

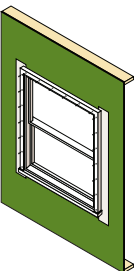

06

ZIP System - Penetration Openings

DISCLAIMER: The following steps represent a general overview for the proper installation of penetration flashing. Please defer to/consult your code requirements in your jurisdiction for full installation details.

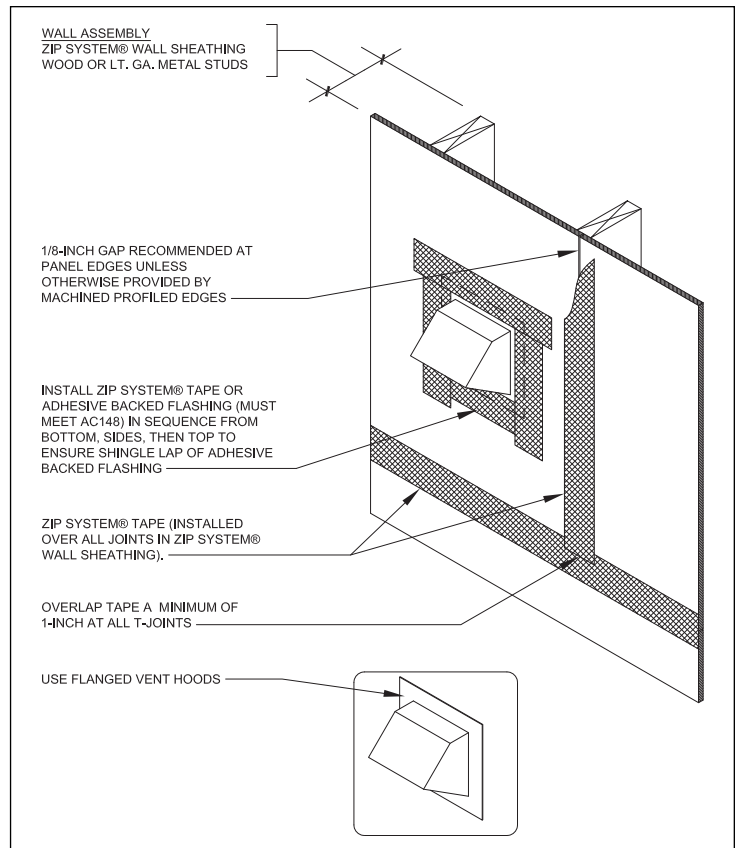
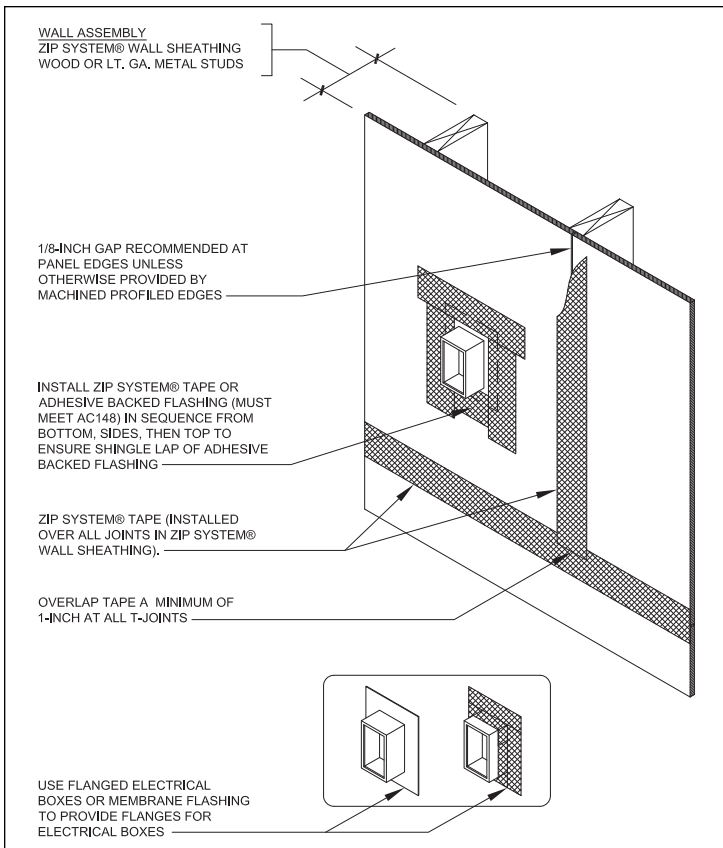
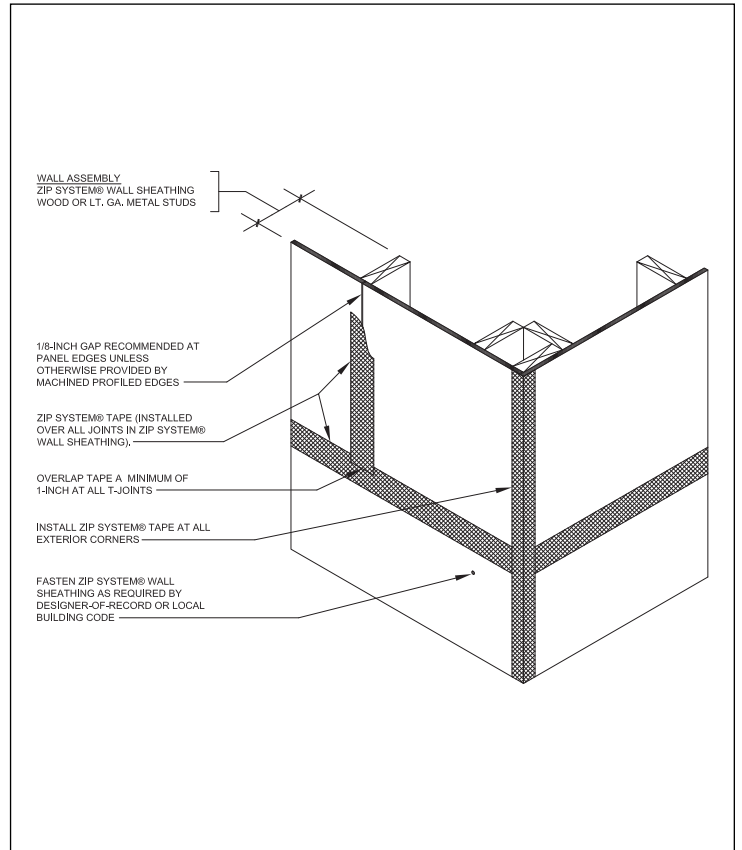
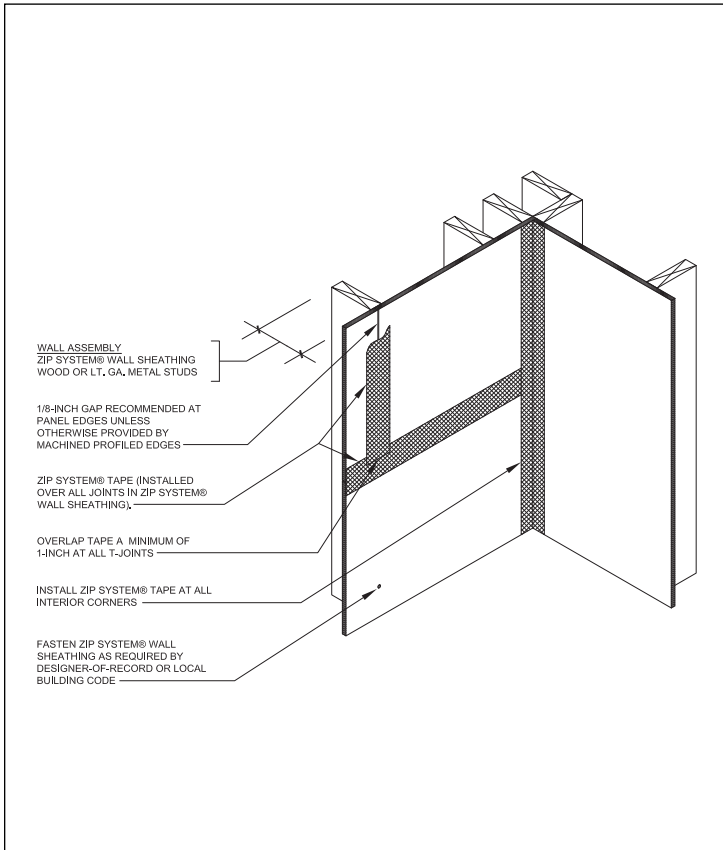

ZIP System Wall Sheathing Installation Details – visit zipsystem.com for more details.

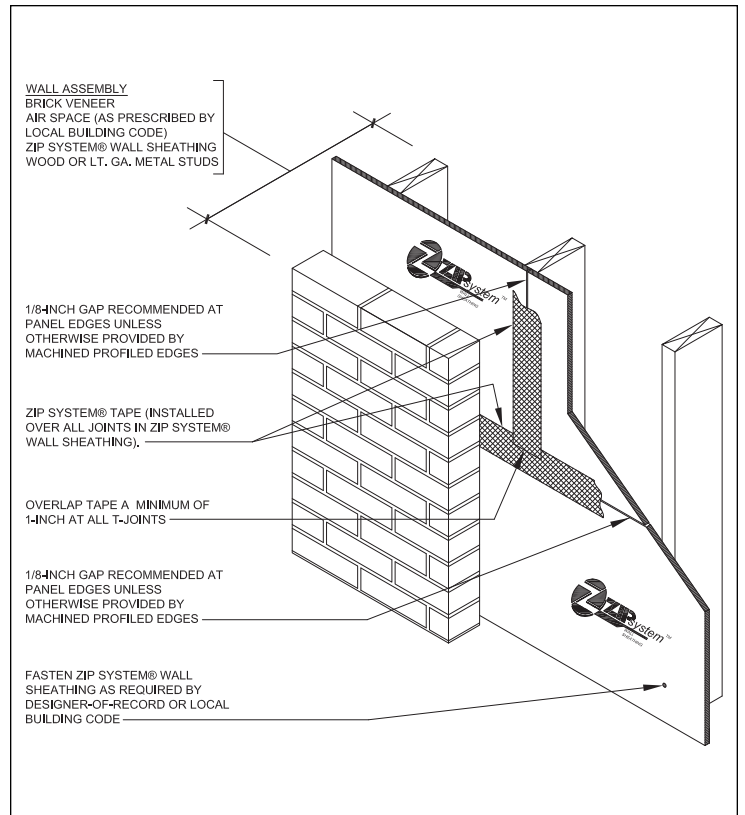
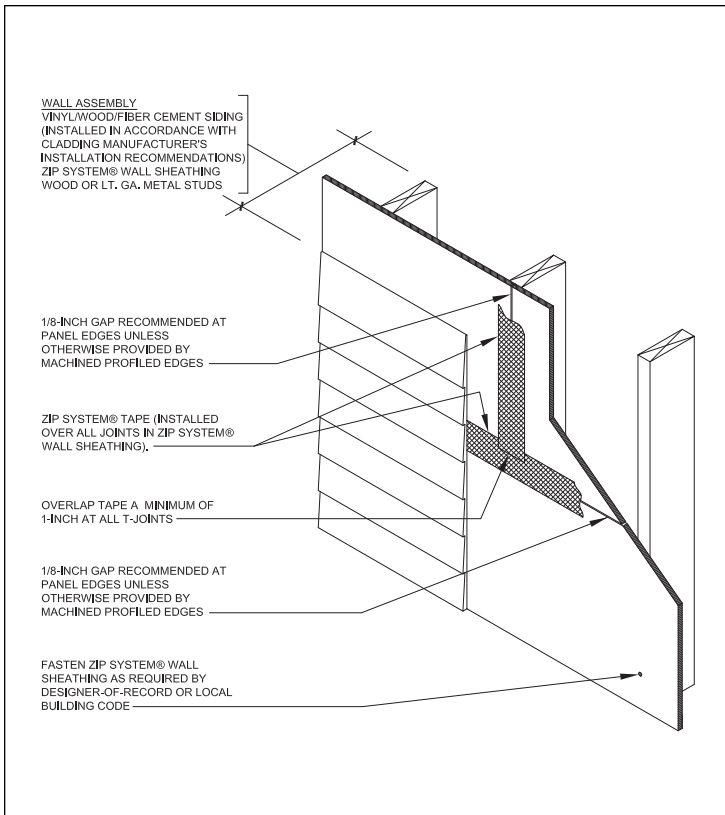
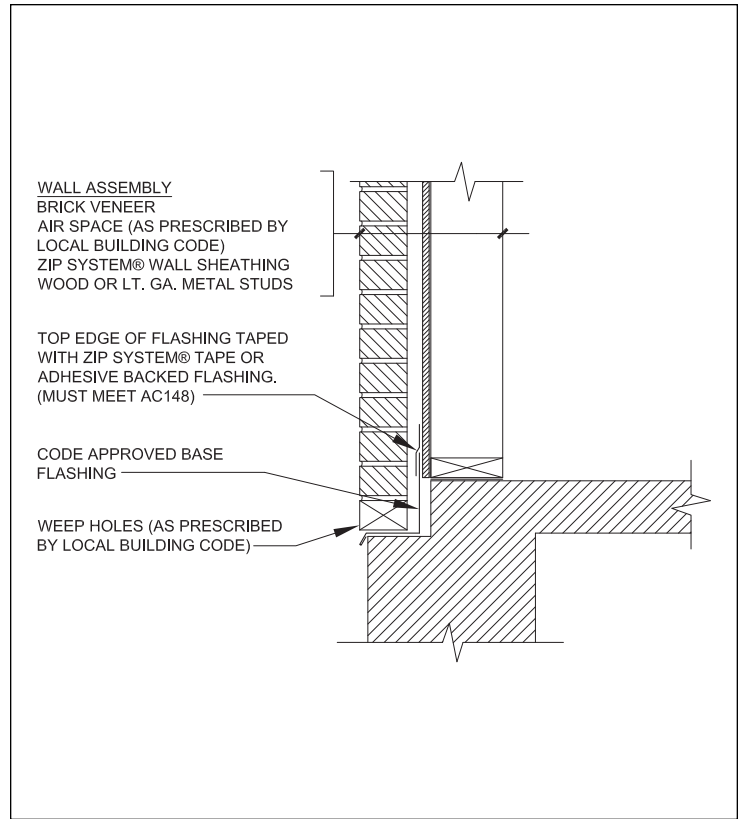
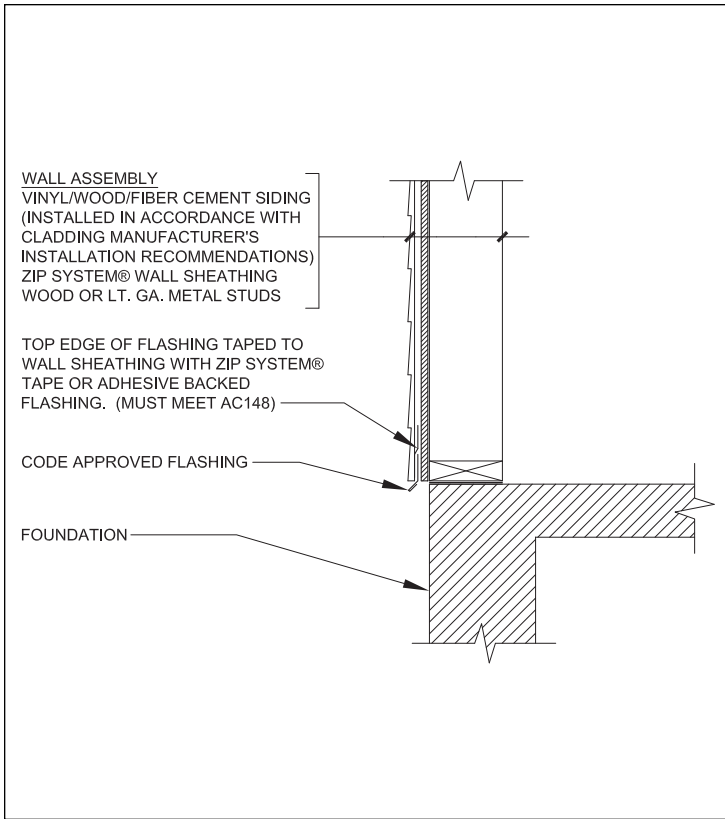

Note: For optimal air leakage reduction, all untaped edges of the panels can be caulked, gasketed or sealed with a weather stripping material.

ZIP System Wall Sheathing Installation Details (continued)

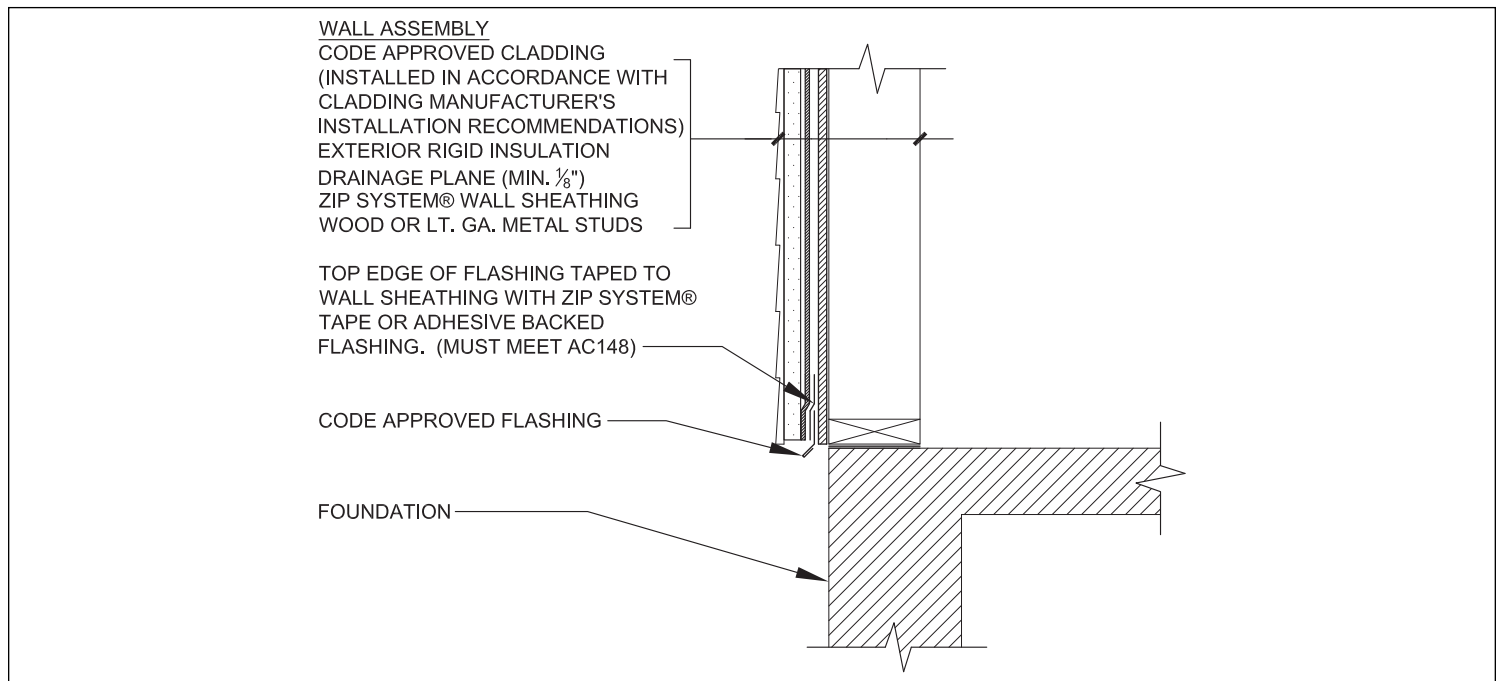
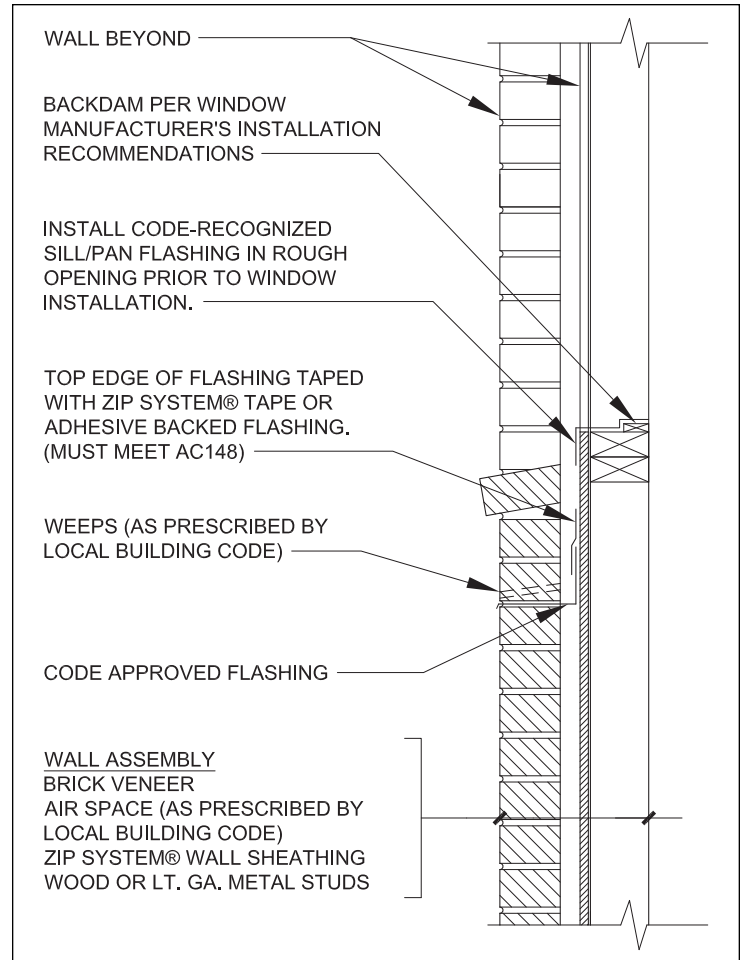
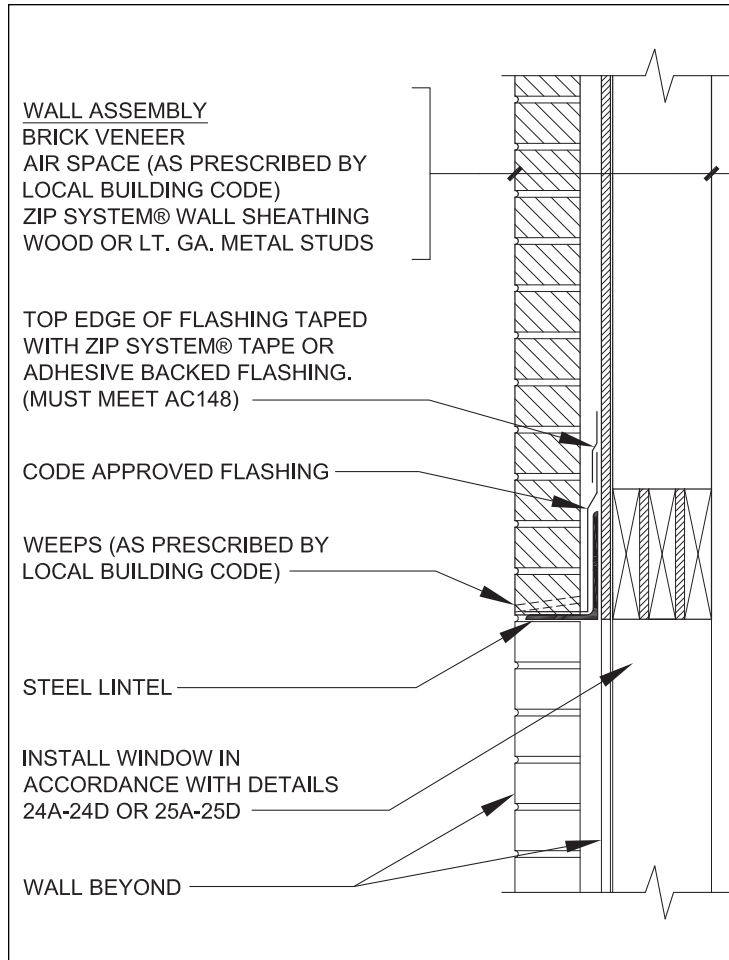

Note: For optimal air leakage reduction, all untaped edges of the panels can be caulked, gasketed or sealed with a weather stripping material.

Printed on 50% recycled paper from sources that have been independently certified for sustainable and well-managed forestry practices.

